



Victor Valley College

2017-2018 Catalog



Victor Valley College 2017-2018 Academic Calendar

June 2017

S	M	T	W	Th	F	S
				1	2	3
4	5	6	7	8	9	10
11	12	13	14	15	16	17
18	19	20	21	22	23	24
25	26	27	28	29	30	

- 10 Spring Semester ends
- 19 Six and Eight-week Summer Session begins
- 22 Grade submission deadline for Spring semester

July 2017

S	M	T	W	Th	F	S
						1
2	3	4	5	6	7	8
9	10	11	12	13	14	15
16	17	18	19	20	21	22
23	24	25	26	27	28	29
30	31					

- 4 Independence Day Holiday
- 29 Six-week Summer Session ends

August 2017

S	M	T	W	Th	F	S
						1
2	3	4	5	6	7	8
9	10	11	12	13	14	15
16	17	18	19	20	21	22
23	24	25	26	27	28	29
30	31					

- 10 Grade Submission Deadline (6-wk Summer Session)
- 12 Eight Week Summer Session ends
- 23 Grade Submission Deadline (8-wk Summer Session)
- 28 Fall Semester Begins

September 2017

S	M	T	W	Th	F	S
						1
2	3	4	5	6	7	8
9	10	11	12	13	14	15
16	17	18	19	20	21	22
23	24	25	26	27	28	29
30	31					

- 4 Labor Day Holiday

November 2017

S	M	T	W	Th	F	S
						1
2	3	4	5	6	7	8
9	10	11	12	13	14	15
16	17	18	19	20	21	22
23	24	25	26	27	28	29
30	31					

- 10 Veteran's Day Holiday
- 11 No Classes ~ College closed
- 23-24 Thanksgiving Day Holidays
- 25 No Classes ~ College closed

December 2017

S	M	T	W	Th	F	S
						1
2	3	4	5	6	7	8
9	10	11	12	13	14	15
16	17	18	19	20	21	22
23	24	25	26	27	28	29
30	31					

- 16 Fall Semester Ends
- 21 In Lieu of Admissions Day
- 22 & 25 Christmas Eve (observed) and Christmas Day
- 26-27 Board Given Holidays
- 28 Winter Break Holiday
- 29 New Year's Eve (Observed)

January 2018

S	M	T	W	Th	F	S
						1
2	3	4	5	6	7	8
9	10	11	12	13	14	15
16	17	18	19	20	21	22
23	24	25	26	27	28	29
30	31					

- 1 New Year's Day (Observed)
- 2 Winter session begins
- 8 Grade Submission Deadline for Fall
- 15 Martin Luther King, Jr. Holiday

February 2018

S	M	T	W	Th	F	S
						1
2	3	4	5	6	7	8
9	10	11	12	13	14	15
16	17	18	19	20	21	22
23	24	25	26	27	28	29
30	31					

- 10 Winter session ends
- 12 Spring Semester Begins
- 16 Lincoln Day Holiday
- 17 No classes ~ College closed
- 19 Washington Day Holiday
- 23 Grade Submission Deadline for Winter

March 2018

S	M	T	W	Th	F	S
						1
2	3	4	5	6	7	8
9	10	11	12	13	14	15
16	17	18	19	20	21	22
23	24	25	26	27	28	29
30	31					

- 30 Spring Break Day
- 31 No classes ~ College closed

April 2018

S	M	T	W	Th	F	S
						1
2	3	4	5	6	7	8
9	10	11	12	13	14	15
16	17	18	19	20	21	22
23	24	25	26	27	28	29
30	31					

- 9-13 Spring Break
- 14 No Classes ~ College Closed

May 2018

S	M	T	W	Th	F	S
						1
2	3	4	5	6	7	8
9	10	11	12	13	14	15
16	17	18	19	20	21	22
23	24	25	26	27	28	29
30	31					

- 28 Memorial Day Holiday

June 2018

S	M	T	W	Th	F	S
						1
2	3	4	5	6	7	8
9	10	11	12	13	14	15
16	17	18	19	20	21	22
23	24	25	26	27	28	29
30	31					

- 8 Commencement
- 9 Spring Semester ends
- 18 Six and Eight-week Summer Sessions begins
- 21 Grade Submission Deadline for Spring

July 2018

S	M	T	W	Th	F	S
						1
2	3	4	5	6	7	8
9	10	11	12	13	14	15
16	17	18	19	20	21	22
23	24	25	26	27	28	29
30	31					

- 4 Independence Day Holiday
- 28 Six week Summer Session ends

August 2018

S	M	T	W	Th	F	S
						1
2	3	4	5	6	7	8
9	10	11	12	13	14	15
16	17	18	19	20	21	22
23	24	25	26	27	28	29
30	31					

- 9 Grade Submission Deadline for 6-wk Summer Session
- 11 Eight Week Summer Session ends
- 22 Grade Submission Deadline for 8-wk Summer Session
- 27 Fall Semester begins

S	M	T	W	Th	F	S
	1	2	3	4	5	6
7	8	9	10	11	12	13
14	15	16	17	18	19	20
21	22	23	24	25	26	27
28	29	30	31			

S	M	T	W	Th	F	S
						1
2	3	4	5	6	7	8
9	10	11	12	13	14	15
16	17	18	19	20	21	22
23	24	25	26	27	28	29
30	31					

S	M	T	W	Th	F	S
						1
2	3	4	5	6	7	8
9	10	11	12	13	14	15
16	17	18	19	20	21	22
23	24	25	26	27	28	29
30	31					

S	M	T	W	Th	F	S
						1
2	3	4	5	6	7	8
9	10	11	12	13	14	15
16	17	18	19	20	21	22
23	24	25	26	27	28	29
30	31					

S	M	T	W	Th	F	S
						1
2	3	4	5	6	7	8
9	10	11	12	13	14	15
16	17	18	19	20	21	22
23	24	25	26	27	28	29
30	31					

S	M	T	W	Th	F	S
						1
2	3	4	5	6	7	8
9	10	11	12	13	14	15
16	17	18	19	20	21	22
23	24	25	26	27	28	29
30	31					

S	M	T	W	Th	F	S
						1
2	3	4	5	6	7	8
9	10	11	12	13	14	15
16	17	18	19	20	21	22
23	24	25	26	27	28	29
30	31					

S	M	T	W	Th	F	S
						1
2	3	4	5	6	7	8
9	10	11	12	13	14	15
16	17	18	19	20	21	22
23	24	25	26	27	28	29
30	31					

S	M	T	W	Th	F	S
						1
2	3	4	5	6	7	8
9	10	11	12	13	14	15
16	17	18	19	20	21	22
23	24	25	26	27	28	29
30	31					

APPROVED BY BOT 11/8/16

Key

- First/Last day of term
- Holiday
-



A Public Community College Founded in 1961

Victor Valley College

-Catalog-

2017-2018

18422 Bear Valley Road | Victorville, CA 92395

(760) 245-4271

www.vvc.edu

Accredited by the Western Association of Schools and Colleges

3402 Mendocino Avenue Santa Rosa, CA 95403 (707) 569-9177

Nursing Program accredited by the California Board of Registered Nursing

Paramedic Program accredited by the Inland Counties Emergency Medical Agency

Respiratory Therapy Program accredited by the Committee on Accreditation for Respiratory Care

The college has made every reasonable effort to determine that this catalog is accurate. Courses, programs, procedures, and policies are subject to change without notice. For the latest information, please visit the website.

Table of Contents

President’s Message	5
Board of Trustees	6
Administration	7
Vision, Values, Mission and Goals	8
Campus Culture and Climate	9
College History	10
What We Offer	12
Campus Locations and Services	14
Co-Curricular Programs	20
Policies and Regulations	21
Admissions and Registration	30
Services for Students	39
Managing Your Education	46
Financing Your Education	66
Graduation and Transfer	73
Learning Outcomes	97
Instructional Programs	99
Programs and Course Descriptions—Credit	103
Non-credit Course Descriptions	422
Faculty and Staff	428
Index	438
Campus Map	Inside Back Cover

Superintendent/President's Message



On behalf of our faculty, staff, and administrators, welcome to Victor Valley College, where we make student success our top priority! I am happy that you have chosen Victor Valley College for pursuing your associate degree for transfer, a career or vocational certificate, or just taking a single class in an area of personal interest to you. We are here to help you.

Perhaps for simplicity sake, we are most commonly referred to as Victor Valley College or just VVC. The college's official name is "Victor Valley Community College District," and there is a reason for the word community being in our name. We are, in fact, the community's college, and we strive to serve the many and varied needs of our community.

It is our goal to make our college the centerpiece of the Victor Valley. College is often thought of as a place to go to take college classes, but it is much more than that. We offer customized training programs to businesses and industries, community education programs in various areas of interest, community-theater and music programs, sporting events, and basic skills classes.

By becoming a student at VVC, you are laying a solid foundation for your future. One of the best ways to become totally engaged is to participate in one or more of the many cultural or social opportunities that are available to you.

VVC provides a rich and diverse environment for you to grow as a student. The various ethnic and cultural experiences that you will be exposed to will help prepare you to work and learn in today's global society.

One last thought as you consider the educational opportunities that you will have before you. Be proactive in your education. Don't wait until you are behind in a class to ask for help. Take on the responsibility and be in charge of your learning. We have a wonderful tutoring center that was created just to help you when you need it.

Again, welcome to Victor Valley College, we wish you the very best with your education here and beyond!

Superintendent/President

Roger Wagner, Ph. D.



Board of Trustees

Elected by the voters of the community, the Victor Valley Community College District Board of Trustees is the governing body of the college.

The Board of Trustees sets overall standards and academic policies for the college and guides the development of college programs and policies.

Policies set by the board are implemented on a day-to-day basis by the superintendent/president of the district and a well-trained group of administrators, faculty, and staff on behalf of the trustees.

Many Victor Valley College students transfer to four-year colleges and universities, and the Board of Trustees designs those educational programs in conjunction with the entire network of community colleges and universities in California.

The Victor Valley Community College District Board of Trustees also works closely with local community and business leaders to establish programs which will benefit the community at large. These and other initiatives are parts of the Integrated Plan mandated by the Board.

Working with employers within the Victor Valley area, the Board of Trustees has approved a number of programs to train students for specific jobs. With these technical programs, the Board of Trustees aims to help provide greater vocational opportunities within the Victor Valley area.

The Victor Valley Community College District Board of Trustees is under the advisory supervision of the California Board of Governors, which oversees higher education in California.

The Board of Trustees is responsible for budgeting funds received from state and local districts for the benefit of the college and its student body.

Meet the Trustees

President



Vice-President

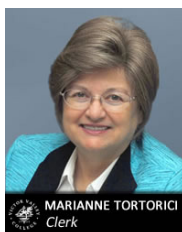

Clerk



Trustee



Trustee



**ASB President
Student Trustee**



Administration

Superintendent/President

Roger Wagner, Ph. D.

Executive Dean Institutional Effectiveness

Virginia Moran, M.A.

Dean of Instruction, Distance Education and Library Services

Melanie S. Jones, Ed. D.

Instructional Dean Humanities & Social Sciences

Patricia Ellerson, Ph. D.

Instructional Dean Science, Technology, Engineering & Mathematics

Hamid Eydgahi, Ph. D.

Dean Student Equity & Success

Herbert English, Ph. D.

Chief of Campus Police

Leonard Knight, DPA.

Executive Vice President Instruction and Student Services

Peter Maphumulo, Ph. D.

Vice President Administrative Services

Tracey L. Richardson, M.B.A., M.S.A.

Executive Dean Technology & Information Resources

Kevin B. Leahy, Ph. D.

Dean Health Sciences, Public Safety & Industrial Technology

Peter Maphumulo, Ph. D. - Acting Dean

Dean of Student Services

Arthur Lopez, M.S.

Director of Human Resources

Raymond T. Quan, M.B.A, M.A.

Vision, Values, Mission and Goals

Vision

Victor Valley College uplifts the diverse communities we teach and serve by promoting educational excellence, enhancing local prosperity, and ensuring environmental leadership.

Values

As a student-centered learning organization, we will uphold the following core values:

- Excellence - providing superior service and educational learning opportunities.
- Integrity - guiding the college's actions with an internally consistent framework of principles.
- Accessibility - facilitating access to the college's programs from other locations.
- Diversity - valuing different points of view and contributions of all.
- Collaboration - encouraging recursive interaction of knowledge experience and mutual learning of people who are working together toward a common creative goal.
- Innovation - providing creative approaches to learning problem solving and growth.

Mission

The mission of Victor Valley College is to:

- Cultivate - intellectual growth, social responsibility, environmental stewardship, cultural enrichment, and economic development.
- Create - exceptional and accessible lifelong learning opportunities that afford students within our expanding communities the attainment of knowledge and skills necessary for success in the global economy.
- Embrace - difference in our communities by integrating their wealth of multicultural knowledge and wisdom into a cohesive and resourceful learning environment for all.
- Inspire - innovative teaching and service with imaginative uses of collaboration and technology, fostering vibrant programs that are measurably effective in addressing student learning and community needs.
- Empower each student to learn by modeling academic integrity, democratic citizenship, and meaningful contribution to society.

Goals

The goals of Victor Valley Community College are as follows:

- Fiscal Stability. The College's financial resources will remain sufficient to support quality programs and services, and the ongoing improvement of all college operations.
- Student Success. The College's courses, programs, and support services advance student success.
- Accreditation Recommendations. All recommendations from the ACCJC will be fully addressed to reaffirm and maintain the College's accreditation status.
- Image. The College's reputation among High Desert residents will be that of a quality institution of higher education.



Campus Culture and Climate

At Victor Valley College there is one constant upon which everything is based: The student is first! This is true in all stages of planning and implementation, including the preparation of the college's budget, program development, and all services offered to the student. It is basic to our success and the success of our students. Accordingly, Victor Valley College seeks to enhance its organizational culture and climate by continuous implementation of all elements of a well-defined plan.

We will:

- Motivate all members of the college community to do their best.
- Recognize that tone and expectation, in essence climate and culture, are at the CEO level.
- Foster the development and support the success of an increasingly diverse student population.
- Encourage a quality-focused paradigm characterized by embracing institutional effectiveness, measuring student success, and creating innovative yet relevant educational programs and services.
- Build cooperation and trust and create cross cultural teams capable of meeting the political and educational demands for effectiveness and quality.
- Develop leaders who are self-confident, group oriented, facilitative of change, catalytic toward quality, and persuasive with all external and internal constituencies.
- Destroy the illusion that constituent groups are separate, unrelated, and often competing forces.
- Provide leadership that will guide activities resulting in appropriate change.
- Promote continuous development of administration, faculty, and staff to provide programs and services of quality and excellence.
- Encourage decision-making to be decentralized, management to be participative, and governance to be shared.
- Advocate a college-wide problem-solving attitude desirous of institutional excellence and a quality college for the 21st century.
- Acknowledge that learning and work can and should be fun and satisfying.
- Thrive on effective communications, vertically and laterally, formally and informally, throughout the organization and in the community.
- Reward and respect quality, excellence, and success, constantly and continuously seek institutional renewal and improvement.



College History

Local History of the Victor Valley

Long before the valley became homesteaded, clean water pools along the Mojave River offered all sorts of weary travelers a life sustaining opportunity to halt their journey and set up camps at a place that would later become known as the Victor Valley (named after railroad engineer, Jacob Nash Victor in the late 1800's). Lush green vegetation, access to water, and indigenous wildlife attracted Native Americans, Spanish missionaries, settlers in wagon trains coming from Utah and other points of departure, miners seeking their fortunes in the gold fields to the north, early explorers, cowboys herding cattle, and later railroad workers.

The next natural step was the arrival of merchants who set up shop out of their wagons to feed, supply and outfit these way-farers. As the stream of travelers increased, the first trading post was established in a place that later became known as Oro Grande. In time, the railroad completed laying track through the mountains and over the desert and people began to settle in the region. It didn't take long before enterprising land developers and businessmen and women saw the opportunity to profit from this influx of people and the region began to grow.

Eventually, the cities of Victorville, Hesperia, and the Town of Apple Valley incorporated between 1962 and 1988. With the commerce, came a need for schools. The first high school (Victor Valley High School) was established in 1915 and served as the only high school for the next 65 years. Since the mid-80s, more than 20 diploma granting institutions were chartered to facilitate the needs of an ever expanding population. The next logical step for the people of the High Desert was to establish a college to serve the needs of the region. It was on the campus of Victor Valley High School that Victor Valley College began its Tradition of Excellence 56 years ago.

College History

The College was originally chartered in 1960 and began operations in 1961. Classes were held in a small building that sat on an upper tier of classrooms at the rear of the high school campus. Only 15 staff, faculty and administrators were employed to meet the needs of approximately 500 students. In 1963, it became evident that the college needed its own space. Valley officials secured the funding through a local bond to purchase land and begin the construction of a new campus that, at the time, would be located at the far reaches of the surrounding communities. Today it is centrally located to the three major cities in the region. The site contained 260 acres of land, formerly known as the Kalin Ranch, and featured river valley bottom land and a mesa rising above the bluff and running parallel to the river. It is on the mesa that the former cattle ranchers maintained a large stock pond that would become the focal point of the campus as it exists today.

The original five buildings still serve students and can be identified by their signature block design and burnt red roofs. The campus opened to students in 1965. Since that time, the campus expanded to include nine new facilities and a vocational technical complex.

A wider transformation has taken place at Victor Valley College because of the passage of the first local bond measure to be approved by the voters since an initial capital bond was passed in the early 60s. In November 2008, the voters approved a bond measure (Measure JJ) dedicated to the elimination of past debt, the upgrade of college infrastructure, the purchase of land for a future campus site in Hesperia, and funding for the construction of the Victor Valley College Regional Public Safety Training Center. Additionally, Victor Valley College completed a one megawatt solar power generating plant that supplies more than a third of the campus' energy needs expand our vocational complex to include new Automotive/Diesel and Welding labs.

In the development and planning stages are the new Student Services 'One Stop' Building' sufficient to provide greater efficiency between related functions in serving our students and the outline for a future stadium and conference center.

Changing Emphasis

Today, the College is a major institution of higher learning offering a complex schedule of educational opportunities to meet the changing needs of this growing region. The college serves between 13,000 and 17,000 students per year. This translates into an annual FTEs between 9,000 - 10,000. Current curriculum includes all the basics for transfer, degrees, certificates and job training. New areas of study include innovative programs in solar panel installation, maintenance and repair; hybrid car maintenance and repair; GPS studies; land restoration; digital animation and much more. Nursing still remains one of the most sought after areas of study offered by the College.

Innovative Partnerships

In 1975, the Victor Valley College Foundation was established to help the College develop additional resources and build partnerships to strengthen the education our students receive. The Foundation has been instrumental in helping the College to expand facilities and educational programs even as the State of California reduced appropriations. While the Foundation regularly receives charitable contributions from generous individuals and grateful alumni to support the College mission, it has also been at the forefront of many of the College's most innovative strategic partnerships. Partnerships facilitated by the Foundation include working with local hospitals to increase the capacity the College nursing program, with representatives of regional mining concerns to develop natural resource management programs; and with a consortium of local governments and employers to establish a new training program for certified aviation technicians in response to an industry need for workforce development. The Foundation worked with the County of San Bernardino Workforce Investment Board to implement training programs that allowed the College to launch programs in hybrid vehicle maintenance, geographic information systems, wastewater reclamation and solar photovoltaic installation. The Foundation also led the community effort to advocate for the passage of Measure JJ in 2008. The Foundation is led by community and college leaders who serve on its board of directors. It accepts donations from thousands of individuals and corporations each year.

Charitable gifts to support Victor Valley College may be made to the Victor Valley College Foundation. For more information visit the Foundation's website at www.vvcfoundation.com.

In 2014, Victor Valley College was awarded a grant to facilitate career pathways pipelines throughout the region in five key industries: Automotive, Aviation, Energy / Utilities Healthcare and Manufacturing. One goal of what has become known as the RAMP UP project is to maximize the input of employers by establishing advisory councils that include all local schools and Victor Valley College together rather than the previous practice of multiple independent meetings at individual institutions. This work was initiated in 2015 and today nearly all targeted advisory councils have been identified or are in active development for the local area. This strategy is expected to help streamline curriculum allowing local students to complete training that meets employer needs faster. Another goal of the RAMP UP project is to link schools and colleges together through technology allowing them to share classes and learning experiences with one another. In 2016, the installation of these classrooms was completed, system tests successfully conducted and the first multi-site connection allowed students at eight high schools to participate in a healthcare industry lecture last month. RAMP UP also includes linkages to the Antelope Valley, Barstow and San Bernardino where similar activities are in development.

A History of Success

For more than 56 years, thousands of High Desert residents have made the journey to Victor Valley College and gone on to become contributing members of society. From their ranks are civic leaders, business people, service industry personnel, medical providers, first responders, and people of all walks of life who are contributors to the health and welfare of our community.



What We Offer

Degrees and Certificates

Victor Valley College awards Associate Degrees, Associate and Certificates. Associate degrees typically require two years of full-time study. However, many certificates, do not require two years to complete. For a complete listing of the degrees and certificates just turn to the section entitled “Instructional Programs.”

Degrees and Certificates include:

- Associate in Science (A.S.) degrees in the areas of Math/Science and various technical areas
- Associate in Arts (A.A.) degrees in the areas of Liberal Arts and Fine Arts.
- Associate Degrees for Transfer (AA-T,AS-T) in various academic and technical areas.
- Certificates of Achievement and Certificates of Career Preparation in various academic and technical areas

Technical Education

The college offers two types certificates in many career technical fields recognized by potential employers. These awards include Certificates of Achievement and Certificates of Career Preparation. For more information as well as a complete list of certificates, please see the catalog section titled “Instructional Programs.”

Information for ESL (English as a Second Language) Students

The ESL Department is designed specifically for English Language Learners whose first language is not English. The program offers noncredit and credit classes at the beginning, intermediate and advanced level. Classes are offered morning, afternoon, evenings and Saturday. The focus of the program is to help improve English language for those seeking to improve their English for academic degree programs, vocational skills and certificates, job success and citizenship. ESL courses use second language acquisition strategies in listening and speaking, reading and vocabulary, pronunciation, basic computer literacy, and job preparedness. Students have access to a Language Lab to enhance language learning and ESL tutors who can help with English learning.

Students can receive information regarding the ESL program and the registration process by attending an ESL Orientation, which is the first step to the matriculation process. ESL students also have the opportunity to meet with an ESL Bilingual Counselor to develop a (mandatory) educational plan. Counselors will discuss academic and career goals and are available to answer any other questions or concerns.

Información Para Estudiantes de Inglés Como Segundo Idioma (ESL)

El departamento de ESL está diseñado para estudiantes que desean aprender Inglés y que su primer idioma no es el Inglés. El programa ofrece clases de crédito y sin crédito en el nivel básico, intermedio y avanzado. Clases se ofrecen en la mañana, la tarde y los sábados. El enfoque del programa es para ayudar a las personas a mejorar su inglés en programas académicos, carreras y certificados técnicos, prepararse para la ciudadanía, además de éxito en el trabajo. Las estrategias de adquisición de segunda lengua usadas para los cursos de ESL son las siguientes: escuchar y hablar, lectura y vocabulario, pronunciación, conocimientos básicos de computación, y para prepararse para el trabajo. Estudiantes tienen acceso a el Laboratorio de Idiomas (Language Lab) para mejorar el aprendizaje del inglés así como tutores de ESL que les ayudan aprender el idioma.

Durante una junta de orientación de ESL y como parte del proceso de matrícula, los estudiantes pueden recibir información sobre el programa de ESL y el proceso para poder inscribirse en sus clases. Estudiantes de ESL también tienen la oportunidad de hablar con un consejero bilingüe encargado de ESL para preparar un plan educativo, y para hablar acerca de las metas académicas y de una carrera futura que sea importante para el estudiante además de responder a cualquier pregunta.

Distance Education

Victor Valley College recognizes the unique contribution that educational technology can make for expanding and enhancing educational opportunities and experiences to the district's growing and diverse student population. It is acknowledged that quality Distance Education (DE) makes special demands on students, faculty, staff, and administrators and that all involved share responsibility for maintaining its effectiveness. Regular effective contact between instructor and students is required as per Title V; discussions, e-mail (both student and faculty initiated), timely feedback on student work, electronic announcements and e-lectures are included in regular effective contact. Students must actively participate in the lecture-designated activities in DE courses to remain enrolled, just as active participation is required in a face-to-face course. Victor Valley College regards DE as integral to the district vision, mission, and goals and endorses and encourages the development, expansion, and improvement of DE methodologies throughout the district's instructional, student, and campus support services and programs.

At Victor Valley College, DE includes courses that are offered fully online and partially online (hybrid). All three of VVC's academic divisions offer DE courses in certain disciplines that are conducive to online learning. There is ongoing and systematic creation, updating and sustainable DE curriculum to serve VVC students and community members. Most DE courses are transferable and/or contribute to AA/AS Degrees; AD-T degrees; and Basic Skills courses. Online and hybrid course offerings for each semester can be found in the Schedule of Classes on WebAdvisor. In addition, a full list of curriculum-approved DE courses can be found at Online Classes @ VVC, under "Approved DE/Online Courses at VVC".

Adult/Community Education

Community & Contract Education

These college programs are designed to fulfill the unique educational needs of the Victor Valley's business and general community members. Because many residents of our local area require skills-based certification training or upgrade courses; this department is managed by the Victor Valley College Foundation and is responsive to the needs of business and the general community.

Community Education:

Traditionally thought of as "hobby classes," Community Education has evolved into a sophisticated platform to develop, administer, and deliver market-driven skills based certification training programs in areas such as Renewable Energy, Health Care, and Public Safety. These programs are specifically designed with input from local subject matter experts and provide a clearly defined career path for students of all backgrounds.

Contract Education: concentrates on workforce training programs customized for business, industry, and other educational agencies. Working closely with faculty and staff, the Department of Contract Education can leverage all of the talent here at VVC and help local business succeed with customized training both on and off-site.

Community Service

Victor Valley College offers self-financing Community Service workshops in areas in which students may desire personal growth or have a particular interest. These are not-for-credit workshops opened to the public with no units attached to them. These self supporting workshops are offered for enrichment in a variety of subjects. Some workshops require an additional material fee or optional fee. Community Service workshops are funded entirely by fees collected at the time of registration. Fees for Community Service workshops are not refundable unless the particular class is canceled.

Campus Locations and Services

Student Services

Building 50:

- CalWORKs - <http://www.vvc.edu/calworks/>
- Disabled Students and Program Services (**D.S.P.S.**) - http://www.vvc.edu/offices/disabled_student_program_services/
- Extended Opportunity Program and Services (**E.O.P.S.**) and Cooperative Agencies Resources for Education (**C.A.R.E.**) http://www.vvc.edu/offices/eops_and_care/index.shtml

Building 52:

- Admissions and Records (**A&R**) - <http://www.vvc.edu/offices/admissions-records/>
- Financial Aid - <http://www.vvc.edu/offices/financial-aid/>
- Bursar's Office - http://www.vvc.edu/offices/fiscal_services/bursars-office.shtml

Building 53:

- Student Services Lab - http://www.vvc.edu/offices/fiscal_services/bursars-office.shtml

Building 55:

- Assessment - <http://www.vvc.edu/offices/admissions-records/assessment.shtml>
- Counseling - http://www.vvc.edu/offices/guidance_and_counseling/
- Transfer Center - <http://www.vvc.edu/offices/transfer-center/>

Building 21:

- Blackboard - http://www.vvc.edu/schedule/online/blackboard_login.shtml
- Blackboard Help - http://www.vvc.edu/schedule/online/blackboard_help.shtml
- Help Desk - http://www.vvc.edu/offices/technical_services/technical-help-for-students.shtml
- WebAdvisor - <https://webadvisor.vvc.edu/>

Building 80 – Rooms 1 and 2:

- Veterans Resource Center (V.R.C.) - <http://www.vvc.edu/veterans/veterans-resource-center.shtml>

Classroom Complexes

ACADEMIC COMMONS (Building 42) - Located at the north side of the lake and is the site for the Office of the Dean of Humanities, Arts, and Social Sciences, Cooperative Education office, Math Success Center, BADM and CIS full-time instructors, and CIS classrooms.

ADMINISTRATION BUILDING (Building 10) - The Administration Building, located on the west end of the campus near Spring Valley Lake Parkway, contains the Administration offices and Human Resources office. On the south side of the building in AD8 where Restaurant Management classes meet.

ALLIED HEALTH BUILDING (Building 32) - The Allied Health Building, located to the northwest of the lake, contains classrooms for the study of nursing, respiratory therapy, and other health-related subjects. Faculty offices are located in portable buildings nearby and the Allied Health Building.

ALLIED HEALTH MODULARS (Building 32A,32B,32C) The modulars are located to the northwest of the lake, adjacent to the Allied Health Building. The modulars are the site for Upward Bound (Math & Sciences) and the AFT faculty offices.

ANIMATION LAB (Building 80) - The 3D Animation Lab is located on the lower campus across from the Gym.

ART (Building 22) - The Art Building is a hexagonal shaped building located west of the lake and is the site for fine arts, graphics, and photography classes. The building also hosts the department's faculty offices.

COUNSELING/ADMINISTRATION (Building 55) - Located on the south end of the lake. This building includes the offices of the Career Center; Counseling; Transfer Center; VVC Foundation, Dean of Student Services, Vice President, Instruction and Student Services; and the Superintendent/President.

Campus Locations and Services

HEALTH AND SCIENCE BUILDING (Dr. Prem Reddy, Building 33) The Dr. Prem Reddy Health and Science Building is located to the west of the Science Lab Building. This building is the site of the Office of the Dean of Science, Technology, Engineering, and Mathematics and contains Nursing and science laboratory classrooms for the life, physical science and Nursing programs.

HUMANITIES CENTER (Building 80) - Located on the lower campus near the corner of Bear Valley and Fish Hatchery Roads.

LIBERAL ARTS BUILDING (Building 30) - The Liberal Arts Building is located behind the Science Lab Building and contains general purpose classrooms, faculty offices, and Office of Instruction.

LOWER PORTABLES (Buildings 66A, 66B) - Houses Administration of Justice classes and the Allied Health lab. These portables are located on the lower campus behind the Construction Technology Building.

MUSIC BUILDING (Building 20) - The Music Building is a hexagonal-shaped building located southwest of the lake, near the Counseling/Administration Building. Music classes are held and practice studios are housed in this complex.

PERFORMING ARTS CENTER (PAC) (Building 54) - The PAC houses Communication Studies (CMST) and Theater Arts (TA) classes. The design lab, lighting lab, costume lab, rehearsal room, make-up lab, and scene shop are located on the first floor of the PAC. The communication studies classroom, communication lab and RamPage are located on the second floor of the PAC.

SCIENCE LAB BUILDING BUILDING (Building 31) - The Science Lab Building is located to the west of the lake and is situated in front of the Liberal Arts Building. This building contains laboratory classrooms for the life and physical science programs, a planetarium and faculty offices.

SEWING COMPLEX (Building 72) - The Sewing Center is located on the lower campus between the Main Gymnasium and the Auxiliary Gymnasium. It also contains a general purpose classroom.

STUDENT ACTIVITIES CENTER (SAC) (Building 44) - Located on upper campus, east of the lake. Classes may be held on the 2nd floor: SAC A, SAC B, SAC C, SAC D, and Quiet Room. The SAC houses the ASB, Public Information Office and PTK offices.

TECHNICAL/VOCATIONAL COMPLEX (Building 60, 60A, 60B, 60C, 61, 62, 63, 64, 65) - The Technical/Vocational Complex, located on the lower campus across from the football field, is the site of specialized classes in areas such as electronics, automotive technology, welding, agriculture, drafting, computer integrated design and graphics, administration of justice and construction technologies. The complex includes an auto shop with specialized equipment, a greenhouse for the cultivation and study of various plants and agricultural crops, and a construction technology center.

TECHNOLOGY CENTER (Building 21) - The Technology Center is located on the southwest corner of the lake between the Art and Music buildings. The 34,117 square foot center is a multipurpose laboratory and office facility that provides voice, video, data and power ports to more than 700 student computer stations. The facility also has a computer center for open entry individual study courses. Faculty offices are located in the building along with special purpose rooms that are equipped with the latest in smart classroom interactive technology. The Computer and Information Resources (CIR), formerly MIS and IT, are located in the technology center.

Off Campus Locations

APPLE VALLEY HIGH SCHOOL (AVHS)
11837 Navajo Road, Apple Valley
760.247.7206

HESPERIA HIGH SCHOOL (HPHS)
9898 Maple Avenue, Hesperia
760.244.9898

SPRING VALLEY LAKE COUNTRY CLUB (SVCC)
13229 Spring Valley Parkway, Victorville
760.245.5223

STERLING INN (STER)
17738 Francesca Street, Victorville
760.245.2999

Campus Locations and Services

Off Campus Locations cont.

WORLD TRADITIONAL TAEKWONDO SCHOOL
17216 Lilac St. Suite 3, Hesperia
760.881.0005

HOOK COMMUNITY CENTER (HKCC)
14973 Joshua Street, Victorville
760.245.5551

SILVERADO HIGH SCHOOL (SVHS)
14048 Cobalt Road, Victorville
760.955.3353

SO CAL LOGISTICAL AIRPORT (SCLA)
18368 Phantom West, Victorville

VICTOR VALLEY COLLEGE
REGIONAL PUBLIC SAFETY TRAINING CENTER
19190 Navajo Road, Apple Valley
760.245.4271 Ext. 2525

VICTOR VALLEY HIGH SCHOOL (VVHS)
16500 Mojave Drive, Victorville
760.955.3300

HIGH DESERT PREMIER ACADEMY
12555 Navajo Road, Apple Valley
760.247.7267

Victor Valley College Regional Public Safety Training Center

The doors to the newest training complex, Victor Valley College Regional Public Safety Training Center, were opened spring 2012 and house Administration of Justice, Fire Technology, Emergency Medical Services, and Corrections programs.

The Regional Public Safety Training Center, a 41,500 square foot building, provides office space, classrooms, conference rooms, a virtual and live shooting range, four fire truck bays, a fire tower, burn rooms, a prop yard with a tanker rail car, and over turned tanker truck and a CERT City facility for citizen disaster and emergency training. The Center is a uniquely designed to provide students with cooperative/crosstraining exercises experienced by first responders while on the job. This facility will assist our students to not only learn their specific areas of study but also to participate in a wide variety of emergency scenarios.

The Victor Valley College Regional Public Safety Center is located at 19190 Navajo Road, Apple Valley CA, 92307. The facility is situated at the corner of Navajo and Johnson Roads next to the Wal-Mart Distribution Center located off Dale Evans Parkway.

RAMS Bookstore

Located in the Student Activities Center/Community Conference Center (Building 44), the Rams Bookstore is owned and operated by the Victor Valley Community College District. Textbooks, trade books, supplies, general merchandise and computer software are available through Rams Bookstore. Other academic supplies such as graduation announcements, graduation regalia and college rings may also be purchased.

Textbook rentals are now available at <http://vvcrams.bookrenterstore.com/>. You can rent your textbooks for a week or a whole semester! The Rams Bookstore is open Monday-Tuesday, 8 a.m.-7 p.m.; Wednesday-Thursday, 8 a.m. - 5 p.m.; and Friday, 8 a.m. - 2 p.m. The hours of operation are extended during the beginning of the Fall and Spring semesters, and the bookstore is open on Saturdays during this period. You can make purchases online by using the Rams Bookstore website: www.vvcRams.com.

Campus Locations and Services

Library

Located at the north side of the lake (Building 41), the library offers a diverse collection that includes books, periodicals, online databases, CDs and DVDs. In addition to circulating books, the library has collections of reference, local history, and instructor reserved materials available for use within the library. Photocopiers, typewriters, video players for instructional tapes and microfiche/film reader printers are also available. Group study rooms may be reserved from the library's website.

Library holdings may be found by searching the online catalog available from the Internet at <http://library.vvc.edu>. There are 34 computers in the library available for accessing the Internet, online catalog, and subscription databases. An ADA workstation equipped with adaptive technology software is available for students. Currently enrolled students may apply for passwords for off-campus access to the subscription databases.

Professional librarians are available at the reference desk during all library hours, providing a variety of information services to help students become more confident and self-sufficient in using the library.

Students must present either a current student I.D. or a registration printout or current ASB card to verify enrollment status each semester prior to checking out materials. Community members may borrow materials by paying a \$12 annual membership fee to join Friends of the Library, a subsidiary of the VVC Foundation. The library charges fees for late returns, damaged or lost materials, according to guidelines set by the College Board of Trustees.

Library hours during the fall and spring semesters are:

- Monday-Thursday, 8:00 a.m.-9:00 p.m.
- Friday, 8:00 a.m.-4:00 p.m.
- Saturday, 10:00 a.m.-3:00 p.m.

Hours during the winter and summer sessions vary.

- For more information call (760) 245-4271, ext. 2262.

Tutoring

Writing Center

Located in the Advanced Technology Center (Building 21, Room 177)

The Writing Center is here to help you make your writing better by working with you at various points of your writing process. You don't need an appointment; just drop by when it's convenient for you, sign in with your student ID number, and let us know what you need help with. We'll help you with everything from beginning an essay or project all the way to printing a final draft. However; our mission is to provide instruction rather than proofreading or editing. This means that we will provide comments and suggestions on the larger or global issues such as thesis, clarity, organization, and paragraphing but we won't fix your grammar, spelling, or punctuation. We will, however, help you find and fix those small errors yourself.

If you are unable to visit the Writing Center in person, you can send your questions, a paragraph, or a paper to the Online Tutor at: http://www.vvc.edu/offices/writing_center/online_tutor.shtml

Math Success Center

Located in the Advanced Technology Center (Building 21, Room 145)

The Math Success Center is here to help you study for your math class. You don't need an appointment; just drop by, sign in with your student ID number, and get the help you need. Come by to study with your classmates, to study on your own, or to get help from the tutors. We have several computers available for your online math homework needs, and the tutors are well-versed in these particular platforms. Individual appointments are available, but they depend on the demand and availability of the tutors.

Campus Locations and Services

Communication Center

Located in the Performing Arts Center (Building 54, Room 213)

The Communication Center is available to all VVC students, staff, faculty, and the public who would like help with the development and delivery of oral presentations from research, outlining, delivery, and visual aids (including PowerPoint presentations). It is not necessary to be enrolled in a communication studies course to use our facility.

The Communication Center is set up to provide one-on-one training to students needing to prepare for a speech or presentation, for any class or public speaking event. Students can also be recorded while practicing their presentation so they can review it and make improvements. Additionally, the center offers multiple work areas including computer stations and individual/group study rooms. Textbooks for CMST courses are kept in the center and may be checked out for use, while in the center. Limited printing services for student work are also available in the center. Students, faculty, and staff wanting information on other areas of communication studies; such as interpersonal and intercultural communication, small group leadership, persuasion, etc., can also find resources.

Campus Security/Police

As to be expected with nearly 17,000 students per year and with open public access to the campus, students need to understand that unlawful activities may occur at Victor Valley College and at activities which the college sponsors. Although the college provides security and takes reasonable preventive measures, it is important that students also take reasonable preventive steps to prevent or avoid criminal behavior. For example, students should keep their automobiles locked and their possessions secured at all times to discourage and prevent thefts.

Campus Police Services

Located on lower campus in Building 80, room 11

Police office hours are Monday-Thursday, 8:30 am to 8:45 pm, and Friday 7:30 am to 3:45 pm. Campus Police can be reached by calling 760.245.4271 ext.2329. After hours and weekends call ext.2555. In an emergency, dial 911.

Amenities

Student Activities Center (S.A.C.)

Located on the east side of the lake, this building (Building 44) is a central gathering place for students, faculty, staff and the VVC Community.

Included in the center are the Associated Student Body (ASB) offices, ASB Computer Lab, Public Information Office, Phi Theta Kappa (Honor Society), Conference Center, Faculty/Staff Dining (Desert Rock Café), Chow Time (Chinese, pizza and American dishes), Rams Café, Auxiliary Services Box Office and Rams Bookstore.

The elevator complex connecting lower and upper campus empties onto the Student Activities Center patio.

Parking Structure

In addition to semester parking permits, the College offers students and visitors an alternate parking option: Parking meters which are located in Lot #1, 6, 7, 9, 19 and 20. They are intended to meet short-term parking needs (meters accept quarters only). Student permits are not valid in metered stalls.

Emergency Phones

Emergency phones are located at several locations around the campus for the safety of students.

Restrooms

Restrooms are located in most main buildings on campus.

Vending Machines

Vending machines dispensing a variety of food and supply products are located throughout the campus.

Campus Locations and Services

Child Development Lab Classroom

The Child Development Lab Classroom (CDLC) is located in Building 12 on upper campus, next to Excelsior Education Center.

We provide a high quality model lab site for college students, as well as providing a safe, nurturing, and developmentally appropriate educational environment for children and families in our diverse community. The primary goal for the CDLC is to provide a Lab for the Child Development Program students. Additionally, we offer observation opportunities to all disciplines and students from any community college or university requiring a Lab experience. As a Lab for the Child Development Program, the CDLC provides ongoing and professional updated resources for students, both male and female, to receive professional training that is required for certification and to observe children in a quality program to further their understanding of child growth and development. The CDLC, state license # 360906573, is funded through a contract from the California State Department of Education, Early Education and Support Division. The CDLC is contracted to offer a State Preschool and must adhere to the Contract funding terms & conditions for both Title 5 and Title 22 regulations. The CDLC operates a part day preschool educational program for families from mid-August to mid-June. This program is offered Monday through Friday, from 8:00 a.m. to 11:00 a.m. or 12:00 p.m. to 3:00 p.m. Children must attend all five days. The Lab is designed to serve the income-eligible child during the year prior to kindergarten. Children are enrolled on a priority basis. For more information, please call the Lab office at 760-245-4271 ext. 2618.

Head Start Program

The Preschool Services Department (PSD) Federal Head Start and Early Head Start programs are offered at the VVC Child Development Center. VVC Head Start/EHS offers Full-Day, Part-Day and Home Base programs which are free to eligible families. For more information, call (760) 952-1087 or (760) 952-1549.

The Preschool Services Department (PSD) Federal Head Start and Early Head Start programs are offered at the VVC Child Development Center. VVC Head Start/EHS offers Full-Day, Part-Day and Home Base programs which are free to eligible families. For more information, call (760) 952-1087 or (760) 952-1549.

PSD serves children 0-5 and also has a program that serves low-income expecting mothers (LIFT Program) at 43 locations throughout the County of San Bernardino. All programs are family-oriented, comprehensive and community-based which address developmental goals for enrolled children, support for parents in fulfilling their parental roles and becoming self-sufficient and linkage to other services and resources. PSD offers a full array of child development and family support services which include:

- Health (Medical and Dental Screenings and Follow-Up)
- Access to Prenatal and Postpartum Care
- Nutrition Education
- Mental Health / Behavioral Services and Support Groups
- Disability Services
- Education and Job Training
- Literacy Programs (Adults and Children)
- Food and Nutrition Services
- Fatherhood Engagement

For more information on PSD's programs, visit <http://hss.sbcounty.gov/psd/> or call (888) KIDS-025

Co-Curricular Programs

Performing Arts Center

Located off Jacaranda Road and Bear Valley Road at the center of the campus, the PAC (Building 54) is a 493-seat proscenium theatre that supports professional dance, ballet, symphony, musical and dramatic stage productions, choral concerts and a wide variety of community events. Seminars, travel lecture series, public forums are also supported. For rental information call (760) 245-4271, ext. 2495.

The PAC houses the Communication Studies (CMST) and Theater Arts (TA) classes. The design lab, lighting lab, costume lab, rehearsal room, make-up lab, and scene shop are located on the first floor of the PAC. The CMST classrooms and the communications lab are located on the second floor of the PAC.

Ticket Information Center

The Performing Arts Center is located on the Victor Valley College Campus. This venue contains two theaters, the Main Stage Theater and the Black Box Experimental Theater. We support instructional, community and professional entertainment and informational programs.

Tickets for college sponsored events may be purchased in person at the Ticket Office or 1 hour prior to performance time at the Box Office.

- Ticket Office: Located at the south entrance of the Student Activities Center (Building 44). Hours are Monday – Thursday 8:30am – 5:00pm and Fridays 8:30am – 2:00pm
- Box Office: Located near the south entrance to the Performing Arts Center (building 54) Open 1 hour prior to each performance.
- Tickets are also available online at www.vvc.edu/tix

If you would like to speak with one of our Ticket personnel, please call (760) 245-4271 ext. 849 (TIX). For information on all other events at the Performing Arts Center, visit http://www.vvc.edu/offices/performing_art/events.shtml

Clubs

Clubs for students with a variety of special interests are an on-going part of campus life. A complete listing of clubs is available from the Office of the Associated Student Body (ASB).

Students interested in a particular activity find that campus clubs are a good way to meet other students and share ideas and information. Interested students may join a club of their choice by contacting the club's president or advisor. Among the clubs on campus are the Model United Nations, California Nursing Students Association, HOSA, Nursing Process 4 Club, EMT Club, Ready Rams, Art Club, Biology Club, Cornerstone Christian Club, AWARE (Adults Who Are Returning to Education) Club, Puente, Art Club, Phi Theta Kappa Honor Society, Physics Club, LGBTQA, Math Club, American Sign Language, BSU, and Off- Broadway Club.

Athletics

Victor Valley College encourages its students to participate in athletic activities to further their physical, emotional, and mental development as individuals.

Athletic facilities are located on the lower campus and include the main gymnasium (Building 71) with a seating capacity of 2,040, 6 outdoor tennis courts, softball diamond, baseball diamond, football field, two soccer fields, and two outdoor sand volley-ball courts.

The intercollegiate sports offered are football, softball, baseball, men's/women's tennis, men's/women's soccer, women's volleyball, men's/women's basketball, wrestling, men's golf, men's/women's cross country, and women's beach volleyball. Victor Valley College Rams compete against other teams within the Western States Athletic Conference, as well as teams from other colleges and universities.

Regarding availability and rental fees, community groups wishing to use any facilities must contact the Facilities Scheduling Office at (760) 245-4271, extension 2707.

Policies and Regulations

Open Class Policy

Victor Valley College strives to maintain an “open class” policy which allows any person admitted to the college to enroll in any course section. Per section 51006 of the Title 5, this includes all students who meet such prerequisites as may be established pursuant to section 55003 of division 6 of title 5 of the California Code of Regulations.

Academic Freedom

Teachers must be free to think and to express ideas, free to select and employ materials and methods of instruction, free from undue pressures of authority, and free to act within their professional group. Such freedom should be used judiciously and prudently to the end that it promotes the free exercise of intelligence and student learning.

Academic freedom is not an absolute. It must be exercised within basic ethical responsibilities of the teaching profession.

Student Handbook

Important procedural and policy information is contained in the Student Handbook, which is available to all Victor Valley College students at no cost. Copies can be downloaded from the VVC website. The Student Handbook includes important information on:

- Activities
- College Regulations
- Matriculation
- Student Services

Student Responsibilities

Students have a responsibility to understand and follow all college policies and procedures.

Students should study the schedule of classes as well as this catalog, which provides a wealth of information on admissions, registration, graduation, transfer, and managing and financing a college education.

Students must plan their own education by carefully considering the courses they take and the requirements for the educational degrees and certificates which they seek.

Student responsibilities include the selection of courses which will complete the general education and major requirements of the area in which they are studying (See “Moving On”).

Counseling and guidance services are available to help students plan and successfully complete their education at Victor Valley College.

Student Conduct

Each student has the right to pursue their education free of any undue infringement on their lawful rights. Victor Valley College follows a “zero tolerance” philosophy when it comes to any behavior or incident that disrupts the learning environment. Student conduct issues are handled in a fair, just manner. AP 5520 provides guidance for this process. In general, student misconduct constitutes good cause for discipline, including but not limited to the removal, suspension or expulsion of a student. Due process for student conduct issues in Administrative Procedure AP 5520. All students are expected to read and follow this important information. In addition, copies are also available on the VVC website, the office of Campus Police and Public Safety, and in the Dean of Student Services Office.

Generally, VVC’s jurisdiction is limited to conduct that occurs on college premises, or at official VVC off-campus activities, except as noted.

Policies and Regulations

Student Conduct Code - Rules and Regulations

Any student found to have committed the following misconduct is subject to disciplinary sanctions. The Discipline Procedures are described in the following section of this publication and they are available in the Office of the Dean of Student Services and the Office of the Director of Campus Police and Public Safety. Normally, any student found guilty of misconduct or more specifically, violence or threats of violence against another will be suspended from the College for a least one semester.

- 1a. Open contempt for any of the following safety rules and regulations.
- 1b. Acts of dishonesty, including, but not limited to the following:
 - a. Cheating, plagiarism, or other forms of academic dishonesty.
 - b. Furnishing false information to any Victor Valley College official, faculty member or office.
 - c. Forgery, alteration, or misuse of any VVC document, record or instrument of identification.
 - d. Tampering with the election of any Victor Valley College recognized student organization.
2. Disruption or obstruction of teaching, research, administration, disciplinary proceedings, other Victor Valley activities, including its public Service functions on or off campus, or other authorized non- Victor Valley College activities, when the act occurs on Victor Valley College premises.
3. Physical abuse, verbal abuse, threats, intimidation, harassment, coercion, and/or other conduct which threatens or endangers the health and safety of any person.
4. Committing sexual harassing or discriminatory behavior based on race, sex, religion, age, national origin, disability, or any other status protected by law.
5. Attempted or actual theft of and/or damage to property of Victor Valley College or property of a member of the Victor Valley College community or other personal or public property.
6. Any fighting or challenging a fight, which threatens or endangers the health or safety of any person is immediate grounds for dismissal or removal from campus.
7. Hazing, defined as an act which endangers the mental or physical health or safety of a student or which destroys or removes public or private property for the purpose of initiation, admission into, affiliation with, or as a condition for continued membership in a group or organization.
8. Failure to comply with directions of Victor Valley College officials (including faculty) or law enforcement officers acting in performance of their duties and/or failure to identify oneself to one of these persons when requested to do so.
9. Unauthorized possession, duplication or use of Keys to any Victor Valley College premises or unauthorized entry to or use of Victor Valley College premises.
10. Violation of published Victor Valley College policies, rules or regulations, including those concerning student organization and the use of college facilities or the time, place and manner of public expression or distribution of materials.
11. Violation of federal, state or local law on Victor Valley College premises or at Victor Valley College sponsored or supervised activities.
12. Use, possession or distribution of narcotic or other controlled substances or poison classified as such by Schedule D (Section 4160 of the Business and Professions Code) except as expressly permitted by law.
13. Use, possession or distribution of alcoholic beverages except as expressly permitted by law and Victor Valley College regulations, or public intoxication.
14. Illegal or unauthorized possession of firearms, explosives, other weapons or dangerous chemicals on Victor Valley College premises.

Policies and Regulations

15. Possession of any article, not usually designated as a weapon, when used to threaten bodily harm on Victor Valley College premises.
16. Participation in a campus demonstration which disrupts the normal operations of Victor Valley College and infringes on the rights of other members of the Victor Valley College community; leading or inciting others to disrupt scheduled and/or normal activities within any campus building or area, intentional obstruction which unreasonably interferes with freedom of movement, either pedestrian or vehicular on campus. Obstruction of the free flow of pedestrian or vehicular traffic on Victor Valley College premises or at Victor Valley College sponsored or supervised functions.
17. Conduct which is disorderly, lewd, indecent, or obscene or expression which interferes with the college's primary educational responsibility or which adversely affects a student's standing as a member of the college community, breach of peace, or aiding, abetting, or procuring another person to breach the peace on Victor Valley College premises or at functions sponsored by, or participated in by, Victor Valley College.
18. Theft or other abuse of phones, electronic devices or computer time, including but not limited to:
 - a. Unauthorized entry into a file to use, read, or change the contents, or for any other purpose.
 - b. Unauthorized transfer of a file (not educational related).
 - c. Unauthorized use of another individual's identification and password.
 - d. Unauthorized use of electronic devices in the classroom including but not limited to head phones, cellular phones and pagers.
 - e. Use of computing facilities to interfere with the work of another student, faculty member or Victor Valley College staff official.
 - f. Use of computing facilities to download or view material deemed to be lewd, indecent and/or obscene matter that is not educational related.
 - g. Use of computing facilities to send obscene or abusive threatening messages.
 - h. Use of computing facilities to interfere with the normal operation of Victor Valley College computing systems.
19. Abuse of the Student Conduct System, including but not limited to:
 - a. Failure to obey the summons of the Student Conduct Hearing Committee or Victor Valley College official.
 - b. Falsification, distortion, or misrepresentation of information.
 - c. Disruption or interference with the orderly conduct of a judicial proceeding or Student Conduct Hearing Committee.
 - d. Institution of a judicial proceeding or Student Conduct Hearing Committee knowingly without cause.
 - e. Attempting to discourage an individual's proper participation in, or use of, the Victor Valley College judicial system.
 - f. Attempting to influence the impartiality of a member of a judicial body prior to, and/or during the course of, the judicial proceeding or Student Conduct Hearing Committee.
 - g. Failure to comply with the sanctions imposed under the Student Code of Conduct and/or Education Code.
 - h. Influencing or attempting to influence another person to commit an abuse of the judicial system.

B. Other Campus Regulations

1. Only officially registered students are allowed to attend classes. Minors or other students who are not registered or do not have permission to be in the class may not remain in the classroom.
2. Students are not permitted to eat or drink in classrooms.
3. Smoking is prohibited in all college buildings or within 20 feet of building entrance.
4. Card playing on Victor Valley College premises is prohibited except in a designated game or recreation area.
5. Only authorized service animals for individuals with disabilities are allowed on Victor Valley College premises. No pets. Visit the Office of Campus Police and Public Safety or DSPS for more information.
6. Printed materials that are not class-related to be distributed must be approved for distribution by the Office of Student Activities.

Policies and Regulations

7. Students must be fully attired, including shoes, while in the classroom or on Victor Valley College premises.
8. Library books and materials must be returned promptly.
9. Use of audio equipment on Victor Valley College premises is restricted to personal headphones or preapproved authorized activities.
10. Children must be under the supervision of parents at all times.

C. Violation of Law and Victor Valley College Discipline

1. If a student is charged only with an off-campus violation of federal, state, or local laws, but not with any other violation of this Code, disciplinary action may be taken and sanctions imposed for grave misconduct which demonstrated flagrant disregard for the Victor Valley College community. In such cases, no sanctions may be imposed unless the student has been found guilty in a court of law or has declined to contest such charges, although not actually admitting guilt (e.g., “no contest” or “nolo contendere”).
2. Victor Valley College disciplinary proceedings may be instituted against a student charged with violation of a law which is also a violation of this Student Code; for example, if both violations result from the same factual situation, without regard to the pendency of civil litigation in court or criminal arrest and prosecution. Proceedings under this Student Code may be carried out prior to, simultaneously with, or following civil or criminal proceedings off-campus.
3. When a student is charged by federal, state or local authorities with a violation of law, Victor Valley College will not request or agree to special consideration for that individual because of his or her status as a student. Victor Valley College will cooperate fully with law enforcement and other agencies in the enforcement of criminal law on campus and in the conditions imposed by criminal courts for the rehabilitation of student violators.

D. Principle of Progressive Discipline

The campus follows a “progressive” discipline process. Complaint forms should be completed and forwarded to either the Coordinator of Student Services or the Coordinator of Student Discipline. Unless inappropriate conduct is egregious and/or requires intervention by law enforcement, the initial contact will result in a verbal warning. Infractions after an initial meeting may result in short or long-term suspension and/or expulsion.

The following are examples of student conduct which may require immediate law enforcement intervention:

providing false information; harassment; sexual harassment; fighting narcotics possession, use, and/or sale, campus demonstrations; lewd behavior; breach of the peace; forging documents; threats; coercion; discrimination; hazing; issues with firearms/explosives; inciting disruptive behavior; indecent and/or obscene behavior; election tampering; physical abuse; intimidation; endangerment; theft or damage to property; failure to comply; issues related to dangerous / illicit chemicals; disorderly conduct.

E. Cheating and Plagiarism Defined

The term “cheating” includes, but is not limited to:

- Use of any unauthorized assistance in taking quizzes, tests, or examinations.
- Dependence upon the aid of sources beyond those authorized by the instructor in writing papers, preparing reports, solving problems, or carrying out other assignments, or acquisition, without permission, of tests or other academic material belonging to a member of the VVC faculty or staff.
- Cheating, plagiarism (including plagiarism in a student publication), or engaging in other academic dishonesty as defined on the next pages

The term “plagiarism” includes, but is not limited to, the use, by paraphrase or direct quotation, of the published or unpublished work of another person without full and clear acknowledgment. It also includes the unacknowledged use of materials prepared by another person or agency engaged in the selling of term papers or other academic materials.

Because VVC is an institution of higher learning, plagiarism and cheating offenses are taken very seriously. A verbal warning may/ or may not be issued prior to a disciplinary action. Disciplinary actions may include, short term or long-term suspension and/or expulsion. The instructor maintains the right to give a verbal warning; give the plagiarized or cheated work a zero or an “F”; or report the student for further disciplinary action (see aforementioned actions).

F. Classroom Discipline

Instructors need to outline classroom rules and behavioral expectations on their syllabus. Examples may include a prohibition on the use of cell phones, the wearing of appropriate lab attire, etc. Faculty may suspend students from class for up to two consecu-

Policies and Regulations

tive class meetings for misconduct and/or class disruption. Instructors must complete an incident report on all suspensions and forward the form to the Dean of Student Services.

An instructor may assign a failing grade on a particular assignment or examination if the student was found to have plagiarized in preparing that assignment or cheated on a particular examination. An instructor cannot automatically fail a student for the entire course where the student is only known to have cheated or plagiarized with respect to one of several assignments that count toward the final grade. An instructor may not administratively drop a student for cheating or plagiarism. A student may only be involuntarily removed from a course due to excessive absences or as a result of a disciplinary action take pursuant to law or the student code of conduct.

Student Grievances

A student may use the following process to file a grievance if they feel they have been unjustly treated academically or administratively:

- **Step 1:** Initial Level - Meet and confer with the person with whom you have a grievance.
- **Step 2:** Chairperson/Dean Level - If the grievance is not resolved in Step 1, you may then take the matter, in writing, to the appropriate department or program Chair, Director, Coordinator or Dean, if there is no chair, within 10 working days. The Chair or Dean will render a decision in writing within 10 working days.
- **Step 3:** Dean/Vice President Level - If the problem is not resolved at Step 2, you may appeal in writing to the appropriate Dean (if the Dean was not involved in Step 2) or Vice President within 10 working days. The Dean/Vice President will render a decision in writing within 10 working days.
- **Step 4:** Final Review - If the problem is not resolved at Step 3, you may appeal in writing to the appropriate Vice President (if the Vice President was not involved in Step 3) or the President within 10 working days, but only on the following grounds:
 - a. There was a significant lack of due process that deprived you of a fair and equitable result.
 - b. The Step 3 decision is clearly unreasonable or arbitrary.
 - c. There is significant newly discovered information which, in spite of reasonable diligence on your part, could not have been produced earlier.

The decision will be rendered in writing within 10 working days and will be final

Student I.D. Card

The Student Identification Card is now required for VVC students and must be presented to access certain classes, computer labs, the weight room, the library and to ride the Victor Valley Transit Authority (VVTA) bus. It can be obtained in the Student Activities Center, 2nd floor. A current class printout and valid picture ID (driver's license, CA ID, military ID, or passport) must be presented at the time card is issued picture ID (driver's license, CA ID, military ID, or passport) must be presented at the time card is issued.

Student Accident Insurance

Board of Trustees Policy 5205 states that all students who are properly registered at Victor Valley College are provided student accident insurance for accidents which occur in class or during college-sponsored activities such as sporting events. This insurance is secondary to other insurances. If a student is injured, claim forms are available in the Risk Management Office or on the VVC website under Risk Management <http://www.vvc.edu/offices/admin-services/risk-management.shtml> .

Equal Opportunity Policy

Victor Valley College is an equal educational opportunity college: It follows all federal guidelines including Title IX of the Educational Amendments of 1972 relating to the recruitment, employment and retention of employees. VVC does not discriminate on the basis of race, color, national origin, sex, age, or disability in any of its policies, procedures or practices. This nondiscrimination policy covers admission and access to, and treatment and employment in, college employment programs and activities. The Section 504-Disabled Counselor/Enabler at Victor Valley College may be reached at (760) 245-4271, extension 2212.

Policies and Regulations

Reglamento Imparcial de Oportunidad

El Colegio de Victor Valley es un colegio de oportunidad educacional imparcial; sigue las guías federales incluyendo el Título IX de la Enmienda Educacional de 1972 la cual se relata al reclutamiento, empleo y la retención de empleados. VVC no hace distinción en base de raza, color, origen de nacionalidad, sexo, edad, o discapacidad, en ninguna de sus reglamentos, prácticas o procedimientos. Este reglamento imparcial abarca admisión y acceso así como también tratamiento y empleo en las actividades y programas de empleo del colegio. Puede llamar a la consejera y habilitadora bajo la sección 504 de el Colegio Victor Valley al (760) 245-4271, extensión 2212.

Nondiscrimination Policy

Victor Valley Community College District provides opportunities for the pursuit of excellence through educational programs and services primarily for college district residents. The purpose of these programs and services is to enhance the quality of human life by providing public access to college education without regard to race, ethnic or national origin, sex, age, disability, sexual orientation, or prior educational status or any other unreasonable basis for discrimination. The lack of English language skills will not be a barrier to admission and participation in vocational education programs. Inquiries regarding the application of this policy may be directed to the appropriate compliance officer for Title 5 and Coordinator for Title IX, Regulation 504ADA - Director of Human Resources, Victor Valley College, 18422 Bear Valley Rd., Victorville, CA 92395 (760) 245-4271, extension 2455

Política No Discriminatoria

El Colegio Victor Valley proporciona, principalmente a los residentes de su distrito, oportunidades a fin de alcanzar metas de excelencia por medio de sus programas educativos y de otros servicios. El propósito de estos programas y servicios es mejorar la calidad de la vida humana haciendo accesible la educación universitaria al público en general, sin prestar atención a su raza, origen étnico o nacional, sexo, edad, insuficiencias o incapacidad física, su orientación sexual, previa situación educacional, o cualquier otra base irrazonable de discriminación. La falta de habilidad en el lenguaje inglés no será una barrera a la admisión o participación en el programa de educación vocacional. Preguntas respecto a la aplicación de esta política pueden dirigirse al oficial designado responsable de la aplicación del Título 5 y al coordinador del Título IX, Regulación 504/ADA - Oficial de Recursos Humanos, Colegio del Victor Valley, Calle Bear Valley 18422, Victorville, CA 92395 (760) 245-4271, extensión 2386.

Discrimination Complaint Procedure

Any student who feels he or she has been discriminated against has the right to file a complaint of unlawful discrimination with the Affirmative Action Officer, Victor Valley College, 18422 Bear Valley Rd., Victorville, CA 92395 (760) 245-4271, extension 2386.

ADA

Victor Valley College does not unlawfully discriminate based on disability. Complaints from students, employees or the public about unlawful discrimination in academic accommodation or access to facilities due to disability should be directed to the ADA504 Coordinator, who is the Director for Human Resources. Students with disabilities are encouraged to seek services at the Disabled Students Programs and Services (DSPS) office, located in Building 50.

Sexual Harassment

It is the policy of Victor Valley Community College District to provide an academic and work environment that is free of sexual harassment and all forms of sexual intimidation and exploitation, as defined and prohibited by federal and state statutes. The District strongly encourages employees and students who believe they are being harassed or discriminated against to file a complaint. All complaints are taken seriously and will be reviewed promptly. All employees have a mandatory duty to report incidents of harassment and discrimination. The Director of Human Resources is charged with receiving complaints of discrimination or harassment and coordinating their investigation. Anyone with questions about this policy or anyone who wishes to file a complaint should contact the Director of Human Resources at (760) 245-4271, extension 2386. Procedures for filing a complaint of sexual harassment are in accordance with Board Policy 3430 and Administrative Procedure 3430. The complaint procedure is available at the Victor Valley Community College website, under Quick Links. A copy of this procedure may be obtained from the Office of the Director of Human Resources, 18422 Bear Valley Road Building 10, Victorville, CA 92395.

Policies and Regulations

Acoso Sexual

Es reglamento del Colegio de Victor Valley proveer un ambiente académico y de trabajo libre de acoso sexual y de todas las formas de intimidación sexual y explotación, así como está definido y prohibido por las leyes federales y estatales. El Distrito anima fuertemente a empleados y estudiantes que creen que están siendo acosados o discriminados a presentar una queja. Todas las quejas se toman en serio y se revisarán puntualmente. Todos los empleados tienen el deber de reportar incidentes de acoso y discriminación. El Director de Recursos Humanos se encarga de recibir las quejas de discriminación o acoso y coordina las investigaciones. Cualquier persona con preguntas sobre este reglamento o que desee presentar una queja debe comunicarse con el Director de Recursos Humanos al (760) 245-4271, extensión 2386. Procedimientos para llenar una queja de acoso sexual son basados en la Directiva 3430 y el Proceso Administrativo 3430 del Colegio. El procedimiento de queja está disponible en la página electrónica del Colegio de Victor Valley. Una copia de este procedimiento también puede obtenerse en la oficina del Director de Recursos Humanos, 18422 Bear Valley Road Edificio 10, Victorville, CA 92395.

Student Record Notice/Directory Information

The Federal Family Education Rights and Privacy Act of 1974 protects the privacy of student records. Student records primarily include those found in the Admission and Records Office (admission application, transcripts, petitions, etc.) and the Office of the Dean of Students (discipline). The required log of access to these records is kept in each office. Officials may access these records when operating within the scope of their assigned duties. Students may have access to their records with appropriate notice and when payment of appropriate cost is made; they may challenge the content as determined by campus policy.

The college is authorized to release directory information, which at VVC includes degrees, certificates, and awards received by students, including honors, scholarship awards, athletic awards, academic recognition and Dean's List recognition. Also included is student participation in officially recognized activities and sports, including height, weight, and high school of graduation of athletic team members. A student may prohibit the release of this information on the initial application for admission.

Student Affirmative Action Plan

Victor Valley College strives to overcome any remaining ethnic, economic, disabled, and gender under-representation in the composition of the student body or any factors that discriminate against students who seek to be educated here. The college has responsibility for ensuring equal educational opportunity for all eligible residents of the district. Within its financial capacity, Victor Valley College will provide for the prompt, fair, and impartial consideration of all student grievances regarding race, color, religion, gender, disability, sexual orientation, or national origin. The college provides access to counseling or grievance procedures for all students and encourages the resolution of students' problems on an informal basis. As an equal educational opportunity campus, Victor Valley College complies with Title IX of the 1972 Education Amendments and Section 504 of the Rehabilitation Act of 1974.

The college will make every attempt to eliminate any remaining barriers that cause significant under-representation of minority, disabled, or economically, educationally, or socially disadvantaged students

Campus Police

Safety - WHAT CAN I DO TO PROTECT MYSELF?

- Be alert!
- Be concerned at all times for your safety and the safety of others.
- Immediately report any suspicious activity and/or persons to the Campus Police.
- Walk and park your vehicle in lighted areas at night.
- Share any safety concerns you have with your Campus Police Department.
- Know emergency numbers and locations of the nearest telephone.
- Report all criminal activity you observe to the Campus Police Department immediately.

Important Campus Telephone Numbers

EMERGENCY 911

CAMPUS POLICE (760) 245-4271 x2329 (after hours & weekends x2555)

CAMPUS POLICE EMERGENCY X2555

Policies and Regulations

VAWA

The Violence Against Women Act (VAWA) is a United States Federal Law signed by President Bill Clinton on September 13, 1994 and renewed in 2005 and again in 2013. It was passed in recognition of the severity of crimes associated with domestic violence, sexual assault, and stalking (<http://www.justice.gov/ovw/about-office>).

In an effort to comply with the law in combating and reducing violence against women in many different areas, Victor Valley College has created a program and policies. More information can be found on our Web site at www.vvc.edu or by visiting the Campus Police Department.

Parking Rules and Regulations

All vehicles parking on the campus must abide by the parking rules and regulations. Semester permits are available online through WebAdvisor. Additional parking is available at the meters. Daily permits can be purchased for \$2.00 at the dispensers in parking lots 3, 6, 11, 13, 16 and at the Public Safety Training Center. Permits are not valid in metered stalls. Permits must be displayed in plain view. Parking permits are required Monday thru Saturday on the main campus and the Public Safety Training Center in Apple Valley. The College provides officers for patrol of the parking lots. However, persons parking on district property do so at their own risk. Victor Valley College does not assume any responsibility for loss or damage to vehicles or their contents while parked anywhere on District property.

Parking Enforcement & Regulations

All vehicles parking on the campus must abide by the parking rules and regulations.

Parking violations may include:

- Not displaying a valid parking permit
- Backed into stalls/head-in parking only
- Not parked in marked parking stall
- Possession of a lost/stolen permit
- Unauthorized parking in Disabled parking stalls
- Improper display of permit
- Unauthorized parking in faculty/staff parking stalls
- Exceeded time at a parking meter
- Unauthorized parking in Red, Green or Yellow zones
- Parking in unauthorized dirt areas

Citations

The VVC Campus Police Department receives its authority to enforce traffic and parking regulations from the California Penal Code, the California Vehicle Code, and provisions established by the California State Legislature. Ignoring a citation will result in immediate legal action in the form of substantial additional penalties and a hold placed on your vehicle registration with the DMV, and a transcript hold at VVC.

- **Motorcycles.** A motorcycle parked at VVC must display a student parking permit which must be affixed to the motorcycle and clearly visible. A staff permit is required on all motorcycles parked in staff stalls.
- **Disabled Persons Parking.** Vehicles parked in the blue-lined disabled persons parking stalls are required to properly display a state-issued disabled person's license placard and a VVC student parking permit.
- **Habitual Parking Offenders.** Any vehicle that has been issued five (5) or more parking citations that are unpaid is subject to tow-away, per CVC 22651.
- **Traffic Rules.** All California vehicle laws are enforced. Violators are issued citations to the Victorville Traffic Court.

Policies and Regulations

Prohibited Conduct On Campus

The following behavior is prohibited on college property or at college-sponsored or college-supervised functions:

- Disorderly, lewd, indecent, obscene or offensive conduct.
- Alcohol or drug use.
- Gambling.

Drug and Alcohol-Free Campus

Victor Valley College is a drug and alcohol-free campus. This means that the use, possession, or distribution of either illicit drugs or alcohol by students or their guests is prohibited on college property or at any college sponsored activity. Students or their guests who violate these requirements may be suspended or expelled from Victor Valley College. Counseling and referral services are available through the Counseling Department for students who have concerns about alcohol or drugs.

Smoke-Free Campus

“Victor Valley College is a smoke-free institution. Smoking or the use of any tobacco products or smokeless devices such as e-cigarettes, is prohibited at all campus sites. Students, staff members and visitors to the campuses of Victor Valley College are permitted to use tobacco products or smokeless devices in their personal vehicles only. Reference: BP 3570”

A woman with dark hair tied back, wearing a dark jacket with a grey and white striped strap over her shoulder, is looking at a bulletin board in a hallway. The bulletin board is mounted on a light-colored wall and contains several papers, including a map and some text. The hallway has a wooden floor and a white door with a number '4' above it. Other bulletin boards with numbers '1' and '2' are visible in the background.

*Admissions and
Registration*

Admissions and Registration

For half a century, Victor Valley College has provided educational opportunities to students with courses and programs of study which meet the diverse needs of students within the entire community.

While most students admitted come from within the Victor Valley Community College District, the college will admit students who live outside the district. Residents of the district may also apply to other California community colleges if they choose. Admissions procedures are basically the same for most students. However, some programs are considered impacted and may require special procedures and approvals for admission. Impacted programs include the Registered Nursing, Respiratory Therapy, and Paramedic programs. The Office of the Dean of Health Sciences, Public Safety, and Industrial Technology, can provide details regarding application procedures and deadlines for these programs. Directors of the individual programs will also provide application information.

Students who are eligible to attend the college must first be admitted to the college, and then register for classes prior to the semester in which they start school. Admissions begins in March for Summer and Fall terms, and in September for Winter and Spring sessions.

Eligibility

Admission to Victor Valley College is governed by the laws of the state and such supplementary regulations as have been prescribed by the Board of Trustees.

Students must meet one of the following criteria to be eligible for admission to Victor Valley College:

- California residents who have graduated from an accredited high school, or who have passed the California High School Proficiency Examination or the General Education Development (GED) test.
- Previous students at Victor Valley College who left in good standing and who have not attended another college or university.
- Transfer students eligible to return to the college or university which they previously attended.
- Any apprentice, as defined in Section 3077 of the Labor Code.
- Out-of-state residents who have graduated from high school.
- Foreign students who meet the requirements for International student admissions and apply by the current deadlines for International student admissions.
- California residents who are at least 18 years old, but have not graduated from an accredited high school or passed a high school proficiency or GED test. These students must have previous training, work experience, or assessment results which demonstrate they would benefit from attending Victor Valley College

Residency Requirements

As a public community college under California law, Victor Valley College is bound by certain legal requirements pertaining to residence which must be observed. Residence is that location with which a person is considered to have the most settled and permanent connection. It is that place where one intends to remain and where one intends to return during absences. Legal residence results from the union of act (physical presence) and intent. (Ed. Code 68062) Residency determination date is the day before the first day of classes for each semester. Residence rules are as follows:

1. California residence: Proof of one continuous residence year in California prior to the above residency determination date is required for purposes of being determined a California resident for tuition and enrollment fees.
2. Nonresidents and International students: International students may be admitted to VVC provided their International student application is approved by the Director of Admissions. A nonresident tuition fee will be charged students who are classified as International students and those who do not meet the one-year California residence requirements. The fee is determined by the VVC Board of Trustees.
3. Member of military: An active military student must provide the Office of Admissions with a statement from the student's commanding officer or personnel officer that the assignment to active duty in the state is not for educational purposes. The student must also produce evidence of the assignment date to California

Admissions and Registration

4. Military dependents: A dependent natural or adopted child, stepchild or spouse of a member of the armed forces of the U.S. should provide the Director of Admissions with a statement from the military person's commanding officer or personnel officer that the military person's duty station is in California on active duty as of the residence determination date or is outside the continental U.S. on active duty after having been transferred immediately and directly from a California duty station. A statement that.

Authority To Determine Residence:

The Director of Admissions is the college official responsible for making residence decisions. Students who need clarification on their residence status may contact the office of Admissions and Records.

Proceso para ESTABLECER RESIDENCIA EN CALIFORNIA

Residencia Física En California

Los siguientes requisitos son usados para determinar la presencia física de una persona en el estado de California:

- Adultos de 18 años o más y son ciudadanos de los Estados Unidos que han declarado su residencia en California por más de un año y un día antes del primer día de clases o del semestre, y se han sostenido independientemente durante ese tiempo y presentan los requisitos de residencia.
- Personas de menos de 18 años que dependen de un residente legal del estado de California por más de un año y un día antes del primer día de clases o del semestre de admisión que requiere una clasificación.

NOTA para los que no son ciudadanos de los Estados Unidos:

El estado residencial de los no inmigrantes son evaluados; dependiendo del estatus o el tipo de visa que tienen eso se usará para determinar la residencia en el estado de California así como el intento de mantener el estado de California como su residencia permanente. Los estudiantes con las siguientes visas B, C, D, F, H-s, H-3, J, M, O-2, P y Q, y los estudiantes que no viven en los Estados Unidos legalmente no están permitidos a establecer residencia en California.

El Intento de Declarar Residencia Física en el Estado de California

El periodo de un año empieza cuando uno no solamente está presente en California pero también ha demostrado clara intención de hacerse residente permanente de California. El solo vivir en este estado por uno año no representa el intento que uno es residente. Reglas de residencia: Pueden establecer residencia en California con los siguientes criterios:

- Mostrar una dirección de domicilio en California en los documentos de impuestos estatales.
- Mostrar una dirección de domicilio en California en los documentos de impuestos federales.
- Documentos que demuestren la entrada a California en forma de un acuerdo legal (ejemplos: casamiento o divorcio).
- Poseer documentos que son requeridos por las fuerzas armadas y que demuestren el estado de California como residente.
- Obtener una licencia de California para práctica profesional.
- Registrarse para votar y votar en California.
- Mantener California como su estado legal de residencia en el formulario W-2.
- Establecer y mantener cuentas bancarias activas y abiertas en California y con su dirección postal (Apartado Postales no se permiten).
- Poseer propiedad donde se reside, o continuamente ocupar una propiedad alquilada en California.
- La tarjeta de registro del SELECTIVE SERVICE con una dirección postal en el estado de California.
- Facturas de cuentas de servicios como de gas, agua, electricidad o teléfono y que tienen un período de un año antes de ingresar al colegio.
- Poseer documentos del estudiante como residente que ha recibido ayuda de rehabilitación, desempleo, welfare u otros servicios estatales.
- Poseer placas y registro de un vehículo motorizado en California.
- Poseer una licencia de conducir de California.

NOTA: Se requieren dos de los documentos mencionados, uno con la fecha de un año y un día antes que empiece el semestre o sesión en que usted piensa ingresar, y el segundo puede ser reciente.

Admissions and Registration

Miembros de las Fuerzas Armadas y/o Dependientes

El colegio de Victor Valley clasifica a los miembros de las fuerzas armadas que no son residentes de California y que están estacionados in California en estado activo como residentes. Sólo se necesita una tarjeta de identificación que indique que están en un estado de servicio activo. El estado de estos estudiantes será verificado semestre por semestre.

Los dependientes de los miembros de las fuerzas armadas que no son residentes del estado de California serán clasificados como residentes mientras el miembro de las fuerzas armadas este estacionado permanente en California.

Special Part-time Students/Special Full-time Students

Admission to VVC - A K-12 student will be admitted to VVC as a special part-time or a special full-time student if it has been determined by the K-12 school that the student is prepared for degree-applicable credit coursework. The school principal or designee must recommend and certify that the student is prepared for college level coursework. For Home School students, a copy of the affidavit which has been filed with the Superintendent of Public Instruction must be submitted to the Admissions and Records office prior to registration. Although the K-12 school makes this recommendation, all students must complete VVC's placement tests in English and mathematics as part of the admission process.

- **Placement test exemptions** - Students enrolling only in music performance, theatrical performance, and/or physical education activity courses are exempt from taking placement tests.
- **Age / Grade Level Restrictions on Enrollment** - Age and/or grade level restrictions vary by course and are determined by the faculty in each department.
- **Unit Limitation** - Concurrent students are limited to enrollment in 11.0 units maximum for Fall and Spring semester and 8.0 units maximum for Winter or Summer Session.
- **All other exceptions to the criteria above requires the submission of a petition.** The petitions will be acted on by the Petitions Committee on a weekly basis. Petitions can be obtained from and must be submitted to the Office of Admissions and Records.

Please visit www.vvc.edu and select Admissions and Records, Concurrent Enrollment Criteria for the most current, up to date information.

International Students

All international students must be at least 18 years of age at the time of registration for classes. An international student attending on a non immigrant student visa (F-1) is required by the United States Immigration and Naturalization Service to maintain full-time student status. This requires a completion of a minimum of 12 units for each semester in attendance.

A certificate of eligibility for non immigrant (F-1) student status will be issued by the Admissions Office only after the following documents are received and approved:

1. International Student Application
2. F1 Visa Student Agreement
3. Financial Certification
4. A minimum score of 500 written, 173 computer-based or 61 Internet-based on English proficiency tests such as the TOEFL
5. Health Questionnaire/Physician Report
6. High School Transcripts
7. College Transcripts (if applicable). Transcripts must include an official English translation by an approved evaluation service
8. \$100 deposit

Tuition set by the California State Legislature. For further information, visit our website at <http://www.vvc.edu/offices/international-students/> or contact the office of Admissions and Records.

Admissions and Registration

Registration

Registration is the process of becoming officially enrolled or registered in your classes.

Properly completing all steps of the most current registration process is the responsibility of the student.

Students interested in attending Victor Valley College can view the schedule of classes Online at www.vvc.edu prior to the beginning of each semester.

Students must register for classes using WebAdvisor through our website: www.vvc.edu. A Help Line is available for assistance or questions; call (760) 245-4271, extension 2740, or email the Help Desk at WebAdvisor@vvc.edu

Registration and other deadline dates are available on our website at www.vvc.edu

Students who do not properly complete the registration process, cannot be admitted to classes or receive course credit.

Registration is a privilege and may be withheld if a student has outstanding loans, unpaid parking fines, returned checks, library fines, or has not returned physical education materials and/or equipment or has other outstanding financial obligations to the college.

Student Registration Priorities

It is the intent of the Board of Governors of the California Community Colleges to provide priority registration for students who enroll in a community college for the purpose of degree or certificate attainment, transfer to a four-year college or university, or career advancement. Registration priority shall be provided to students who have completed orientation, assessment, and developed a student education plan, remain in good academic standing and have not completed more than ninety (90) degree-applicable semester units at Victor Valley College.

Registration priority, in the order of priority listed below, shall be provided to students as follows:

BLOCK 1 = HIGHEST PRIORITY | BLOCK 6 = LOWEST PRIORITY

Matriculated in Good Standing (Title 5, section 58108)

BLOCK 1

- Member of the Armed Forces and Military Veterans (Education Code 66025.8)
- Homeless Youth and Former Foster Youth (Education Code 66025.9)
- EOPS students (Title 5, section 58108 and 56232)
- DSPS students (Title 5 section 56026)
- CalWORKS students

BLOCK 2

- 2A – Continuing students with 45.0 – 90.0 units completed at Victor Valley College. Students with more than 90.0 units completed at Victor Valley College with an approved petition.
- 2B – ASB Council members, Work Study students, Active Phi Theta Kappa members, Spouses of Disabled Veterans, Student Athletes, Active PACE program students, and qualified K16 Bridge High School graduates (fall semester only).

BLOCK 3

- 3A – Continuing students with 30.0 – 44.5 units completed at Victor Valley College.
- 3B – Continuing students with 15.0 – 29.5 units completed at Victor Valley College.
- 3C – Continuing students with 0.0 – 14.5 units completed at Victor Valley College.

BLOCK 4

- New / Returning / Transfer students

BLOCK 5

- Concurrently enrolled K-12 students.

Admissions and Registration

BLOCK 6

- Students not fully matriculated.
- Students not in good standing (e.g. academic and/or progress probation for two consecutive semesters as defined in Title V section 55031.)
- Students with more than ninety (90) degree applicable units earned at the district.

Students may appeal the loss of priority registration due to one of the following reasons:

1. Extenuating circumstances which are verified cases of accidents, illnesses or other circumstances beyond the control of the student.
2. A student with a disability applied for, but did not receive reasonable accommodation in a timely manner.
3. Academic and/or Progress improvement. Students must demonstrate significant academic and/or progress improvement.
4. Enrollment in a high unit major or program. High unit programs generally include Nursing, Respiratory Therapy or preparation for transfer to programs in engineering, medicine or other areas.

A Loss of Priority Registration Appeal form may be filed with the Admissions and Records Office.

Definitions of Student Classifications

Matriculated students in good standing are students who complete orientation, assessment and education plans (Title 5, section 58108), who are not on academic or progress probation for two consecutive terms (as defined in Title 5, section 55031) and who have earned 90.0 or fewer degree-applicable semester units at Victor Valley College (Title 5, section 58108).

- Continuing students are students currently enrolled at VVC.
- New students are first time students attending any college.
- Returning students are those who attended VVC in previous semesters but are not currently enrolled.
- Transfer students are those who have completed courses at other colleges or universities.
- Concurrent enrollment students are those concurrently enrolled in grades K-12.

Petition Process for Loss of Priority Registration

Victor Valley College has established written procedures by which a student may appeal the loss of priority registration status due to extenuating circumstances, or where a student with a disability applied for, but did not receive reasonable accommodation in a timely manner.

Extenuating circumstances are verified cases of accidents, illnesses or other circumstances beyond the control of the student. Victor Valley College may exempt from the ninety (90.0) unit limit category those students enrolled in high unit majors or programs. Victor Valley College may allow students who have demonstrated significant academic improvement to appeal the loss of priority enrollment status. Petitions are available at the Admissions and Records office.

Requirements for Registration

The Office of Admissions and Records must receive all required materials prior to registration at Victor Valley College.

Required materials include:

- A completed admissions application and statement of legal residence to the college. Apply online at www.vvc.edu.
- Applicable Prerequisite Challenge/Equivalency form.
- For veterans, receipt of a copy of honorable discharge papers or DD 214. Military personnel on active duty should submit a copy of their military orders.
- Applicable International Student forms.

Admissions and Registration

- Establishment of California residency, without which nonresident tuition must be paid (see Non-Resident Tuition section in Section VI-Financing Your Education).
- The completion of all admissions procedures, orientation, assessment, and student education plan requirements, except for any existing exemptions.
- Concurrent Enrollment Form (K-12).
- Students (other than Concurrent K-12) may register for a maximum of 18 units for either fall or spring semester.
- Concurrent K-12 students may register for a maximum of 11 units for either spring or fall semester.

All students may register for a maximum of 8 units for the summer and winter session.

Payment of Fees Deadline

After completing registration, it is necessary to pay all required fees. Administrative Procedure 5030 requires that students pay all registration fees in full within five (5) working days of registration. Beginning the first day of each term, fees must be paid within 24 hours of registration. Students may be dropped for non-payment of fees. It is important to keep a copy of your Registration statement for your records.

Students who receive a scholarship or who receive third party payment vouchers from agencies such as the Department of Rehabilitation, Department of Veterans Affairs, GAIN, Workforce Development, or other third party agencies must present their voucher to the Bursar's Office for verification and processing. Verified vouchers will be treated as an acceptable form of payment. Students are responsible for processing their own vouchers.

Payment plans, complete financial aid award letters and/ or BOG fee waivers will also be treated as acceptable forms of payment. Students are responsible to submit applications and required documentation in a timely manner to ensure processing.

Program Changes (Adding/Dropping)

It is the student's responsibility to complete the drop and/or add process. WebAdvisor Online registration is the method to use for adding or dropping classes.

Students who want to add a class once classes have started, should do so as soon as possible (see authorization codes for more information). The deadline to add a class is strictly enforced. Late adds will be considered for verifiable extenuating circumstances only. Students must be registered in class prior to census.

Authorization Codes

If you are given permission to add a class by an instructor, an authorization code will be provided to you and you will register with your code using WebAdvisor.

Once classes begin, registration fees are due within 24 hours of adding a class.

NOTE: Authorization codes are valid until the deadline to add classes. Instructor deadlines to use authorization codes may be earlier than printed class deadlines.

Admissions and Registration

Withdrawing from Classes

A student may drop or withdraw (or be dropped by an instructor), before the 44% point of the completion of the class. Students may not drop or be dropped after this point, and instructors must issue a grade beyond this point. A student who drops a class (or who is dropped by an instructor) on or prior to 20% of the course will have no record of that class on their permanent transcript, although they may still be responsible for payment of fees. Drops that occur after 20% of the course, and on or before 44% of a course, will result in a W symbol being entered. Students may be dropped for lack of attendance or for “good cause” as defined in the Education Code, Article 3, Sect. 76033.

STUDENTS SHOULD NOT RELY ON INSTRUCTORS TO DROP OR WITHDRAW THEM FROM CLASSES. Failure to officially drop or withdraw by the deadline may result in the assignment of an F (Failing) or FW (Unofficial Withdrawal) grade.

Refer to the Add/Drop policy and important Dates and Deadlines Online at www.vvc.edu listed under Admissions and Records.

Wait Lists

Before the beginning of the semester, if a class is closed, you may place your name on a waitlist. If a seat becomes available, you may automatically be added to the class depending on your place on the waitlist and your student account will be charged with enrollment fees which are due within five (5) working days of being added to a class.

IMPORTANT: Check WebAdvisor frequently to see if you have moved from the wait list to enrolled status.

IT IS THE STUDENT’S RESPONSIBILITY TO CONFIRM ENROLLMENT AND PAY ANY ADDITIONAL FEES.

Transcripts for Admissions

Transcripts showing work completed at other colleges and universities must be received by the Office of Admissions and Records no later than the end of the first semester of attendance.

Transcripts received become the property of Victor Valley College and cannot be returned to the student or forwarded to other schools.

Courses, units, and grades which are accepted from other accredited colleges and universities will be applied toward the completion of academic degrees or certificates of completion at Victor Valley College.

Transcripts from foreign schools or universities must be evaluated by an approved credential evaluation service.

Prerequisites, Co-requisites, Advisories

Victor Valley College enforces the prerequisites, co-requisites, and limitations on enrollment which have been formally established and are listed in the class schedule and college catalog. In some cases students will be responsible for submitting at the time of admission, documentation that they have met all prerequisites. If you enroll in a course but do not meet the enrollment conditions, you will be dropped from the course.

1. A “Prerequisite” is a course or other condition of enrollment which a student must meet with a grade of “C” or better before enrolling in a course or program.
2. A “Co-requisite” is a course which a student must take simultaneously in order to enroll in another course.
3. An “Advisory” or recommended preparation, is a course or other condition of enrollment which a student is advised, but not required to meet, before or concurrent with enrollment in a course or program.
4. “Limitations on Enrollment” are conditions for enrollment in honors courses or courses which include public performance or intercollegiate competition.

Admissions and Registration

Any student who does not meet a prerequisite or co-requisite, or who is not permitted to enroll due to a limitation on enrollment, may seek entry into the class through initiating a challenge based on one or more of the following reasons:

1. The prerequisite, co-requisite, or limitation on enrollment violates VVCC District Policy 5109.
2. The prerequisite, co-requisite, or limitation on enrollment violates Article 2.5 of Title 5 of the California Administrative Code.
3. The prerequisite or co-requisite is unlawfully discriminatory or is being applied in such a manner.
4. The student has the knowledge or ability to succeed without meeting the prerequisite, co-requisite, or limitation on enrollment.
5. The prerequisite or co-requisite has not been made reasonably available and the student as a result will be subject to undue delay.
6. A limitation on enrollment will delay by at least one semester the attainment of a degree or goal specified in the student's Education Plan.
7. Enrollment will not pose a threat to the student or others in a course with a health and safety prerequisite.

The Challenge Process requires the approval of a fully completed Challenge Form available from the Admissions and Records Office. Challenges involving academic qualifications, health and safety, or non-course prerequisites such as interview or recency require approval of the chair of the department in which the course is offered. Challenges based on unlawful discrimination require approval by the VVC Affirmative Action Officer.

Late challenges will be considered but enrollment will not be guaranteed pending their resolution.

For more details contact the Office of Admissions and Records or the Counseling Office.

Withholding of Student Records

Grades, transcripts, diplomas, and registration privileges, or any combination thereof, may be withheld from any student or former student who has failed to pay a proper financial obligation due to the District. Any item or items withheld are released when the student satisfactorily meets the financial obligation.

The definition of proper financial obligation includes, but is not limited to: student fees; obligations incurred through the use of facilities, equipment or materials; library fines; unreturned library books; materials remaining improperly in the possession of the student; and/or any other unpaid obligation a student or former student owes to the District. A proper financial obligation does not include any unpaid obligation to a student organization.

A hold may be placed on a student's academic record and subsequent term registration when the student has an outstanding obligation to the District. Once the student satisfies the obligation, the hold will be released.

Student Honors

The President's List, the Dean's List, and the Honor Roll are marks of superior academic achievement.

To qualify for these prestigious honors, students must complete at least 12 units of credit classes with a letter grade (A, B, C) each semester (Fall/Spring) and achieve outstanding grades as follows:

- To qualify for the President's List, a student must achieve a grade point average of 4.0 or an "A" grade in all classes.
- To qualify for the Dean's List, a student must achieve a grade point average of 3.50 - 3.99.
- To qualify for the Honor Roll, a student must achieve a grade point average of 3.0 - 3.49.

Admissions and Registration

Graduation Honors

Students completing associate degree programs with prescribed cumulative grade point averages are recognized as honor graduates through the college commencement exercises and diplomas. These honor graduates are eligible to wear honor cords at graduation.

All lower division, degree-applicable courses, units, and grades earned by students at VVC and other colleges and universities are included in calculating grade point averages for graduation and academic honors.

Academic honors are as follows:

- Highest Honors 3.90 - 4.00 GPA
- High Honors 3.75 - 3.89 GPA
- Academic Distinction 3.50 - 3.74 GPA

These honors are noted on student diplomas.



*Services for
Students*

PANORAMA

CalWORKs

CalWORKs is a program that assists students who are receiving County aid (TANF). Cal-WORKs assists those students with educational goals including degrees and/or certificates approved by the County. We provide assistance with books, supplies, transportation, parking permits, and childcare. CalWORKs also has a work-study program that allows us to place students with local employers to meet their state-required activity hours without affecting their aid.

For more information, stop by the CalWORKs Office in Building 50, or call (760) 245-4271, ext. 2592.

CAREER/TRANSFER CENTER

Students interested in obtaining career information or transfer options should visit this unique multifaceted center.

Career Center

Students interested in career exploration should visit the Career Center (co-located with the Transfer Center) to take advantage of the wealth of information available there. Trained staff, utilizing computerized guidance programs and professional publications, will assist you with career research. A library of career related materials such as reference books and career websites can be used to discover career alternatives. Online assessments are also available to help students identify career interests and educational goals. The Career Center also hosts various workshops throughout the year to help students learn about internships, career preparation and exploration. Located in Building 55, the Career Center is open Monday through Friday from 8:30 a.m. – 5:00 p.m. For further information, call (760) 245-4271 ext. 2139, or visit www.vvc.edu/career. See Career Exploration websites at the end of the “Moving On” section.

Transfer Center

Students who plan to transfer to a four year university to earn a bachelor’s degree after attending VVC should visit the Transfer Center. At the Transfer Center, students can meet with the transfer counselor, may schedule appointments to meet one-on-one with university representatives, research institutions and majors for potential transfer, borrow college/university catalogs, request university general education certifications, and attend trips to university campuses. In addition, the Transfer Center provides a variety of transfer-related workshops, and staff will help students to fill out transfer admissions applications and complete all the steps necessary for a smooth transition. Visit us in Building 55 Monday through Friday from 8:30 a.m. to 5:00 p.m. For further information, call (760) 245-4271 ext. 2139, or visit www.vvc.edu/transfer.

THE COMMUNICATION CENTER

Located upstairs in the Performing Arts Center, Building 54, Room 213, the Communication Center assistants are trained to work with students, individually or as a group, in the various stages of speech and/or oral presentation development including brainstorming techniques, research, organization, speech composition, and incorporation of visual aids. Additionally the center offers individual and group appointments for presentation practice and feedback providing students with specific suggestions for overall improvement.

Services currently offered by the center include: speech composition and delivery, development of effective visual aids, taping and viewing services, printing, scanning, navigation of the Blackboard platform, and Power Point instruction. The center is annexed into several strategic areas including the simulated classroom that allows students to familiarize themselves with the surroundings and equipment they will encounter when giving a presentation, multiple computer workstations with Internet and Microsoft Office access, five breakout rooms that can be reserved by individuals or groups of students. It is not necessary for the students to be enrolled in a Communication Studies class in order to access the center. For more information you may contact the Communication Center at (760) 245-4271 x2820 during the Fall and Spring Semesters for hours of operation and other information. You can also find us by searching the VVC homepage or directly at www.commcenter@vvc.edu.

Services for Students

COUNSELING SERVICES

Counseling services are available to all students. Students are invited to come in for confidential help in strengthening academic performance, selecting an educational major, developing educational and career plans, solving situational problems, and improving self-understanding.

Career Planning

Counselors can assist students with exploring career options. Students are also encouraged to enroll in a career planning class, GUID 100. This educational planning class helps students discover their own interests, attitudes, values, and will help them make an initial career choice.

Academic Counseling

Counselors are available to help students plan their long and short-term educational goals, and then match classes and majors to their particular needs and interests. Information on the college's requirements for certificates of achievement and graduation with an Associate degree is available, as is help in determining transfer requirements to other schools.

Social/Personal Development Counseling

All through life, people must fit into society, both at work and in their leisure time. To make this process easier for students, the college offers both individual consultations with a counselor and special group sessions through the personal development courses, such as GUID 56, 100 and 105.

The college maintains a staff of professionally educated counselors to serve its students. Counseling services are available to every student and member of the college community. With professional counselors, students may explore freely and in confidence concerns which are important to them.

DISABLED STUDENTS PROGRAMS AND SERVICES (DSPS)

Disabled Students Programs and Services are located in Student Services II, building #50. This program provides accommodations and services to students with various disabilities who are determined eligible for the program. Students with disabilities which will impact their academic experience at Victor Valley College and who want to receive services must apply at the DSPS office. Students will be asked to provide appropriate documentation to verify their disability.

Who may be eligible?

Currently enrolled students with disabilities which impact them academically may be eligible for DSPS services. Examples of disabilities, which may impact the academic experience, are: students with mobility, visual, hearing, speech, psychological and other health impairments as well as learning and developmental disabilities are served. The student with a disability seeking admission to Victor Valley College must meet these levels of independence:

1. The ability to negotiate the campus facilities independently or with the assistance of an attendant
2. The ability to take care of personal needs (feeding, toileting) unassisted or to provide one's own attendant
3. The possession of a stable level of health to benefit from a full semester's work

The Adaptive Computer Technology Lab (ACT)

DSPS provides students with disabilities with a variety of computer software designed to provide access despite environmental technological barriers. Screen readers, speech-to-text, adaptive software applications, and assistive technology and other programs will assist students with their academic pursuits.

DSPS Courses

DSPS Courses DSPS also offers, when staffing permits, courses in the area of disability related issues designed to provide information, support, and learning strategies to students with disabilities. These are subject to change but may include:

- DVST 1,2,3 – "Language Analysis Development" These courses provide activities designed to address language based learning disabilities
- DVST 4A and 4B – "Mathematical Reasoning" These courses addresses the perceptual and language deficits that can interfere with understanding mathematical concepts and operations

How to Apply?

Complete a Victor Valley College admissions applications application online at: www.vvc.edu. Request a DSPS application at the DSPS Office. You will also need to provide proof of your disability from a licensed or certified professional (forms are available at the DSPS Office). If you have a learning disability, bring a copy of your most recent Psychological-Educational Report and IEP. For further information contact DSPS at 760.245.4271 ext. 2212/2433; or visit our website at http://www.vvc.edu/offices/disabled_student_program_services/.

EXTENDED OPPORTUNITY PROGRAM AND SERVICES (EOPS)

Extended Opportunity Program and Services (EOPS) (a state-funded program) provides book service, priority registration, tutoring, career counseling, student assisting, and other support services to disadvantaged Victor Valley College students.

To be eligible for EOPS, a student must be a resident of California and be enrolled in at least 12 units of classes for Fall and Spring, but not have received an associates degree (AA/AS) or completed more than 70 degree applicable units from any college, including Victor Valley College. Students must also be qualified for the Board of Governors Waiver A or B (financially disadvantaged) and be educationally disadvantaged based on Victor Valley College Assessment Scores.

To apply for EOPS, students must submit an application to the EOPS Office, located in Building 50. Office hours are Monday through Friday from 8:30 a.m. to 5:00 p.m. Summer: Monday through Thursday 8:30-5:00 p.m.

K16 BRIDGE PROGRAM

VVC's K16 Bridge Program was originally designed by teachers, counselors and administrators to increase the number of students successfully transitioning to a post-secondary institution. High Desert high schools participating in the program are able to provide their students with lessons, activities, and projects that provide students a clear pathway when they enter college.

The K16 Bridge Program meets the new Student Success Act requirements for matriculation, and is developing programs that will help students enter college better prepared in math and English. Students completing the program are eligible for Block 2B priority registration their first semester at VVC. All High Desert K-12 schools in the VVC region are eligible to participate.

K16 BRIDGE SCHOLAR PROGRAM

The college's K16 Bridge Scholar Program is a way to provide students uninterrupted priority registration for those graduating from a local high school with a GPA of 3.5 or higher. Students who attend a designated Bridge High School can apply in the spring of their senior year for provisional entry into the Phi Theta Kappa Honor Society (PTK). Upon acceptance into the program, seniors will be granted priority registration for their first year at VVC. Students maintaining a cumulative GPA of 3.5 and completing at least 12 transferable units during their first semester at the college can apply to PTK to change their status from provisional to lifetime membership. Students going through this program could receive up to two years of priority registration.

High school students with a cumulative GPA of 3.5 or better, who plan on graduating midterm, can apply for provisional membership in PTK in November of their senior year. Midterm grads will need to contact the Bridge Counselor at their high school for matriculation information and time lines. Students granted provisional membership in PTK will need to maintain their 3.5 GPA and complete 12 transferable units by the end of their first semester at the college to become lifetime members of PTK.

MATH SUCCESS CENTER (MSC)

Located in the Advanced Technology Center (Bldg. 21 Room 176)

Phone: (760) 245-4271 ext. 2788 or contact ext. 2149 (Nichole Carver)

Hours of Operation: Monday – Thursday 9:00am – 8:00 pm and Friday 9:00 am – 5:30 pm

The Math Success Center is here to help you study for your math class. You don't need an appointment; just drop by, sign in with your student ID number, and get the help you need. Come by to study with your classmates, to study on your own, or to get help from the tutors. We have several computers available for your on-line math homework needs, and the tutors are well-versed in these particular platforms..

Services for Students

THE WRITING CENTER

Located in the Advanced Technology Center, Building 21, Room 177, students are invited to drop in to the Writing Center to get help with and work on their writing projects, no appointments necessary. Staff and student tutors are trained to work with students on a variety of writing tasks, everything from getting started to drafting essays to revising for grammar, punctuation, and spelling errors.

The Writing Center holds workshops on writing strategies every day and provides computer access and reference texts to help students. Fall and spring hours are Monday through Thursday 9:00-7:00 and Friday 9:00-3:00; winter and summer hours vary. For further information on services and hours of operation, call (760) 245-4271, extension 2607. For those students not regularly on campus, visit our website for writing information and online tutoring: www.vvc.edu/offices/writing-center/

STUDENT SERVICES LAB

The Student Services Lab (Bldg. 53) is primarily for new students that are completing the application/ registration and financial aid process. Students can also print documents for student support programs.

Students are allowed to complete the following items below:

- Apply for admissions
- Complete online orientation
- Complete and/or update financial aid (FAFSA) application
- WebAdvisor
- Add or Drop classes
- EOPS and/or CalWORKs forms

STUDENT ACTIVITIES

Many activities and services are available to students who attend Victor Valley College. College services help facilitate each student's educational career and should make college life more pleasant and productive while students pursue their educational goals.

Student Body Privileges

Every student enrolled at Victor Valley College is a member of the student body and is entitled to participate in both academic and extracurricular activities at the college.

The Associated Student Body (ASB) is the organization which constitutes official membership in the community of students at Victor Valley College.

ASB fees are \$10 for all students during the Fall and Spring Semester and \$5 during the Winter Intersession and Summer Session. These fees are used to support the Athletic programs, Theatre Arts productions, student events and also afford the student availability to scholarship programs, community discounts and access to the ASB Computer Lab.

Students receive an ASB card which entitles them to free admission to all VVC dance, music and theater performances, discounts to other activities, and free copies of the Victor Valley College newspaper/newsletter and other campus publications such as the college viewbook. In addition, ASB card holders are eligible to compete for Associated Student awards, scholarships, and to hold office in student government.

Student Clubs

Clubs for students with a variety of special interests are an on-going part of campus life. A complete listing of clubs is available from the Office of the Associated Student Body (ASB).

Students interested in a particular activity find that campus clubs are a good way to meet other students and share ideas and information. Interested students may join a club of their choice by contacting the club's president or advisor. Among the clubs on campus are the Model United Nations, California Nursing Students Association, HOSA, Nursing Process 4 Club, EMT Club, Ready Rams, Art Club, Biology Club, Cornerstone Christian Club, AWARE (Adults Who Are Returning to Education) Club, Puente, Art Club, Phi Theta Kappa Honor Society, Physics Club, LGBTQA, Math Club, American Sign Language, BSU, and Off- Broadway Club.

Student Government

As members of the Associated Student Body of Victor Valley College, all students are eligible to vote for student representatives to student government and to participate in the government of their campus.

Elections for the ASB Council are held in the spring of each year. ASB election information is available through the ASB office located on the 2nd floor of the Student Activities Center. ASB Council meets on a regular basis and determines social policies and program activities for students at Victor Valley College. Students on campus are encouraged to bring matters of interest before the council or to sit in on student council meetings.

According to the ASB Constitution, ASB students who are taking six or more units with a cumulative grade point average of 2.0 are eligible to run for office or be appointed to student government positions.

The student council's executive board consists of a President, Vice President, Executive Senator, Secretary and Treasurer.

Air Force ROTC

Through arrangements with California State University, San Bernardino (CSUSB), students may participate in the Air Force Reserve Officer Training Corps (AFROTC) program. Aerospace Studies classes and Leadership Laboratories are conducted each Friday on the main campus of CSU-San Bernardino.

Air Force ROTC is a college-level program designed to select and train highly qualified men and women to become commissioned Air Force officers. After graduation from college and completion of all Air Force ROTC requirements, cadets are commissioned as second lieutenants in the U.S. Air Force. Typical service is four years; however, service duration for pilots, navigators and nurses is longer. These individuals serve in a broad range of careers to include actual flying, engineering, administration and a host of other fields, depending on the individual's academic background.

To enter Air Force ROTC, an individual must have at least two years of college remaining, which may include graduate study. In addition, the individual must be a United States citizen prior to entering the last two years of the program, be available to pass an Air Force medical exam, be of high moral character and be in good academic standing in school. Entry into the last two years of the program is on a competitive basis. Students are required to graduate with a bachelor's degree, in any academic major, and complete one of the two program options. AFROTC offers 2, 3, and 4-year scholarships of up to \$15,000, but scholarships are not required to participate in the program. AFROTC cadets under scholarship and all juniors and seniors receive a \$300- \$500 per month tax-free stipend, plus a \$900 textbook allowance each year. Currently, CSU-SB does not charge for courses. No military commitment is incurred until entering the last two years of the program (Professional Officer Course) or accepting an AFROTC scholarship.

Classes consist of one hour of academics plus two hours of leadership laboratory for freshman and sophomores. Juniors and seniors will have three hours of academics plus two hours of leadership laboratory. The academic hours earned can normally be counted as elective credit toward graduation. All AFROTC classes and laboratories are held on Fridays to better accommodate students commuting from other colleges and universities.

For more information, contact the California State University, San Bernardino (CSU-SB) Department of Aerospace Studies (AFROTC) at (909) 537-5440. Details are also available here: afrotc.csusb.edu and <http://DoSomethingAmazing.com>.



*Managing Your
Education*

MATRICULATION / STUDENT SUCCESS and SUPPORT

Matriculation is a process that brings a college and a student who enrolls for credit into an agreement for the purpose of realizing the student's educational objective through the college's established programs, policies, and requirements. As a student you have certain rights and responsibilities, and as an institution of higher learning, Victor Valley College has some obligations to you. Here is a brief overview of some of these factors.

VVC agrees to . . .

- Provide admission and registration services.
- Provide assessment services.
- Orient you to college programs, services and policies.
- Provide assistance in selecting courses and defining an educational major and plan.
- Provide support services and provide quality instruction.
- Provide appropriate follow-up and referral services.

VVC students agree to . . .

- Declare a broad educational goal on initial enrollment (transfer, AA. . .).
- Participate in assessment and orientation and have all prior transcripts sent to VVC.
- Read the Catalog, Schedule of Classes, Student Handbook and other college materials.
- Meet all course prerequisites, corequisites and limitations.
- Attend the first class session of each class and regularly attend all classes.
- Properly add and drop all classes.
- Complete class assignments.
- Develop an Educational Plan and choose a specific educational major by the completion of 15 units.
- Seek support services as needed.
- Make progress toward your goals by successfully completing classes.
- Follow all campus rules and regulations.

Matriculation Steps

The objective of Matriculation is to attain your goals in education by defining an agreement between you and the college. Responsibilities are established that utilize the programs and resources of VVC to efficiently complete certificate or degree programs.

APPLICATION - Complete the VVC admission application Online. Notify previous colleges to send transcripts to VVC.

ORIENTATION - Orientation is available to familiarize you with VVC policies, programs, and services.

ASSESSMENT - Complete the computerized Assessment/Placement process for reading, sentence skills and math as one component of course selection.

Assessment Exemptions:

If one of the following conditions applies to you, you may choose not to complete the Assessment and/or Orientation. Provide documentation supporting your exemption to the Counseling Office.

- You have completed an Associate Degree or higher at a regionally accredited college or university.
- You have completed an approved Math or English course at a regionally accredited college or university.
- You have assessment scores taken within the last three (3) years at a California community college.
- You are currently enrolled in a four-year college or university.
- You are a concurrently enrolled student (K-12) only enrolling in music performance, theatrical performance and/or physical education activity courses.

Other factors considered in the selection of courses include study habits, certainty of educational goals, specific skills, emotional well-being, employment, family or other commitments, family support, health, maturity and motivation, self assessment, education history, etc. See the table of course sequences for Math and English listed in this section.

You have the right to challenge your Assessment Placement results and course recommendations.

Managing Your Education

COUNSELING

Before or sometime during your first semester, make an appointment with a VVC Counselor to discuss course selections, choosing an academic major, and developing an Educational Plan which lists the courses you need to meet your academic goal. The Ed Plan should be developed no later than the completion of 15 VVC credits, and may be revised as needed. Counselors can also assist with personal issues and career choices.

Also, consider taking the following Guidance courses:

- GUID 50 College Success
- GUID 51 College Orientation
- GUID 55 Building Math Confidence
- GUID 56 Self Esteem
- GUID 100 Career Planning
- GUID 101 First Year Experience
- GUID 105 Personal and Career Success
- GUID 107 Learning Strategies

Please note that following these steps may affect your priority registration status.

Challenge to Matriculation Policies

Students may appeal any portion of the matriculation policies by contacting the Dean/VP of Student Services. This includes claims that the process is unlawfully discriminatory or is being applied in such a manner. The Dean or Vice President will conduct a timely review and make such adjustments as are appropriate. The VP's office maintains a record of all complaints.

Reto a la Política de Matriculación

Estudiantes pueden hacer una petición sobre cualquier parte de la política de matriculación (menos los requisitos). Ésta petición tiene que ser dirigida al Decano de Servicios Estudiantiles. Peticiones incluyen reclamaciones acerca del proceso discriminatorio. El Decano conducirá una revisión para hacer los ajustes que sean apropiados. El expediente de reclamos es mantenido en la oficina del Decano de Servicios Estudiantiles por tres años.

Units and Credits

College Units

A unit is a value that indicates the amount of college credit given to a course. In general, one hour of lecture a week or three hours in a laboratory equals one unit of credit.

Full Time student

Students are considered full-time if they take 12 or more units during a normal 16-week semester, 6 units during an 8-week term or 4 units during a summer or winter session.

Deciding how many units to take

A common schedule is 15 college units per semester. Successful students should expect to spend two hours per week of study time for each unit taken. With a 15 unit course load, you'll spend approximately 45 hours a week in and out of class. In order to determine how many units to take you should consider certain factors such as:

- If you work, how many hours a week?
- How much time do you need to devote to other responsibilities like family and relationships?
- How much time do you need for personal needs such as sleeping, eating and traveling to and from college?
- How much time do you need for housekeeping chores, socializing, recreation and other interests?

Changes to Priority Registration Effective Fall 2013 -The California Community Colleges Board of Governors approved changes that will establish system-wide enrollment priorities designed to ensure classes are available for students seeking job training, degree attainment or transfer and to reward students who make progress toward their educational goals.

New students who have completed college orientation, assessment and developed education plans as well as continuing students in good academic standing who have not exceeded a locally capped limit of 90 units (not including units in basic English, Math or English as a Second Language) will now have priority over students who do not meet these criteria.

Active-duty military and veterans, current and former foster youth, followed by students in Extended Opportunity Programs and Services and Disabled Students Programs and Services will continue to have first priority for registration if they meet the same criteria listed above.

Managing Your Education

The regulations, unanimously approved by the Board of Governors, will be phased in beginning in the fall of 2013. We encourage students on probation to seek help to improve their academic standing. Students nearing 90 units should carefully plan their remaining courses.

Students may appeal the loss of priority enrollment due to extenuating circumstances, or where a student with a disability applied for, but did not receive reasonable accommodation in a timely manner. Extenuating circumstances are verified cases of accidents, illnesses or other circumstances beyond the control of the student. A Loss of Priority Registration Appeal form may be filed with the Admissions and Records Office.

The College may allow students who have demonstrated significant academic improvement to appeal the loss of priority enrollment status. Significant academic improvement is defined as achieving no less than the minimum grade point average and progress standard established in section 55031 for the term or terms. A Loss of Priority Registration Appeal form may be filed with the Admissions and Records Office.

The College may exempt from the ninety (90) unit limit category those students enrolled in high unit majors or programs as defined by the College.

FOR ADDITIONAL INFORMATION, please refer to the “Admissions and Registration” section of this catalog, AP5055 or contact the Admissions and Records Office.

Schedule of Classes - Every term, a schedule of classes is posted at www.vvc.edu.

The following is a recommended formula to determine the total time required for success in a class:

Example: For a 4-unit class you could expect:

In-class time	=	4 hrs. per week (1 hr. for each unit)
Homework	=	+8 hrs. per week (2 hrs. for each unit)
Total time	=	12 hrs. per week for one 4-unit class

Keep in mind that the summer and winter session is only six weeks long (Fall and Spring semesters are 16 weeks long) so a student will spend twice the amount of time and have twice the amount of homework during a summer or winter session.

Managing Work and College recommendations

- If you work 15 hours/week, consider enrolling in no more than 12 – 15 units.
- If you work 25 hours/week, consider enrolling in no more than 9 – 12 units.
- If you work 40 hours/week, consider enrolling in no more than 4 -8 units.

Maximum Units in Remedial Classes

Students at Victor Valley College are eligible to enroll in a cumulative maximum of 30 semester units of remedial classes including reading, writing, mathematics, learning skills, and study skills courses. For example, the Basic Skills Program includes 10 one credit courses which would count as remedial level work. Remedial classes also include English as a Second Language (ESL) courses which are designed to ensure acquisition of skills necessary for completion of associate degree, transfer, and technical courses.

Students identified by the district as being learning disabled are exempt from the 30-unit maximum. Students with other types of disabilities may be exempted on a case-by-case basis.

Waivers of this policy may be made for students who show significant, measurable progress toward the development of skills appropriate to their enrollment in college-level courses, yet need limited course work beyond the 30 semester unit limit. Significant and measurable progress is defined as completion of precollegiate basic skills classes with grades of “C” or better, or a grade of “credit” if the course is categorized as mandatory credit/non-credit.

The Petitions Committee is granted the authority to issue Remedial Semester Unit Limitation waivers.

Unless provided with a waiver, students who do not attain full eligibility status for college-level work within the prescribed 30 semester unit limit are to be dismissed and referred to adult non-credit education courses.

Managing Your Education

Dismissed students may petition for reinstatement for the purpose of enrolling in college-level course work upon successful completion of appropriate adult noncredit classes or upon demonstration of skill levels which can reasonably be expected to assure success in college-level courses.

Grade Appeal Process

According to the California Education code Section 76224 (a), California Code of Regulation Section 55025 (a), if mistake, fraud, bad faith, or incompetency is the reason for a grade dispute, the burden of proof lies with the student to produce facts that support this allegation. If such evidence exists, the student is to initiate an informal discussion with the specific faculty member and/or the Department Chair. If the matter is not resolved through this informal discussion, the student may obtain a Grade Appeal Form from the Office of Admissions and Records or online in the Students Form Center.

Final grades are issued after the close of each term. The student has two years following the semester in which the grade was recorded to request a change of grade or to request any corrections to the academic record. After the two-year limit, no changes may be made.

Grade Points

Cumulative grade point averages are calculated by dividing the total number of grade points by the total number of units attempted. For the academic record, calculations are made on a semester and on a cumulative basis.

Here is the system of evaluative grade symbols and grade points currently in effect:

Grade Symbol	Explanation	Grade Points
A	Excellent	4.0
B	Good	3.0
C	Satisfactory	2.0
D	Passing	1.0
F	Failing	0.0
FW*	Unofficial Withdrawal	0.0

*Note: An "FW" grade is issued when a student has ceased participating in a course sometime after the last day to officially withdraw without receiving district authorization to withdraw from the course under extenuating circumstances.

OTHER SYMBOLS: (NOT CALCULATED INTO GPA)

- P** Pass (not counted in GPA, equivalent to "C" or better)
- NP** No Pass (not counted in GPA, less than "C")
- I** Incomplete
- W** Withdrawal from class IP In Progress—Class extends beyond the end of the academic term. Remains on the permanent record to satisfy enrollment documentation but is replaced by the grade and unit credit when the course is completed. Not used in calculating GPA. RD Report Delayed Assigned by the Registrar when the assignment of a grade is delayed due to circumstances beyond the control of the student. This is a temporary symbol, not to be used in calculating GPA, and to be replaced by a permanent grade as soon as possible.
- MW** The "MW" is to be assigned for students who are members of an active or reserve military service and who receive verified orders compelling a withdrawal from courses. The "MW" symbol is not counted in Progress Probation and Dismissal calculations.

VVC Math Pathways

STEM

Science, Technology,
Engineering, Math

(the “traditional” pathway)

For the following majors:

- Applied Behavior Analysis
- Applied Sciences
- Architecture
- Astronomy
- Biology
- Business Administration
- Chemistry
- Computer Science
- Criminal Justice
- Economics
- Education

- Engineering
- Environmental Science
- Health Science
- Kinesiology
- Math
- Mechanical Engineering
- Nursing*
- Physical Science
- Physics
- Sports Medicine
- Structural Engineering
- Surveying

*These majors may have special circumstances based on the college/university you transfer to, as well as how far in the discipline you intend to study. Please consult a counselor or the Transfer Center for further direction.

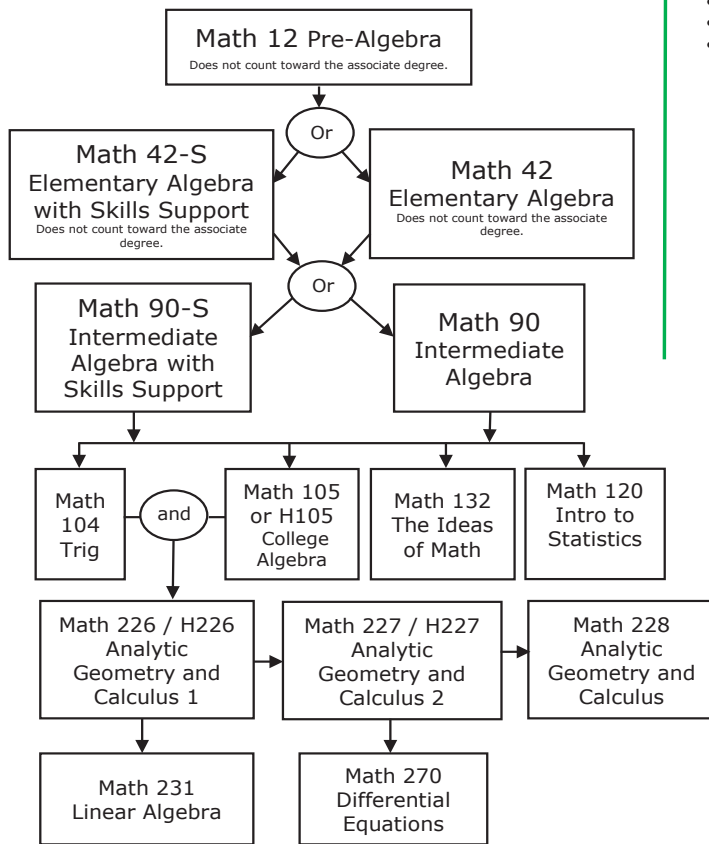

Non-STEM

(for those requiring less math)

For the following majors:

- Allied Health
- Anthropology
- Art, Art History
- ASL (sign language)
- Auto
- Broadcast Media
- Business*
- BET (Business Education Technologies)
- Child Development*
- Communication
- CIS (Computer Information Systems) *
- Computer Animation & Graphics
- Construction Technology
- Culinary Arts
- Dance
- Dental Hygiene*
- Ecology*
- English
- Environmental Health*

- Environmental Science*
- Fire Technology
- Geography
- Government
- History
- Music
- Agriculture and Natural Resources Horticulture
- Paralegal
- Paramedic
- Philosophy
- Political Science*
- Psychology*
- Real Estate
- Restaurant Management
- Social Work*
- Sociology*
- Spanish (Foreign Languages)
- Theater Arts

*These majors may have special circumstances based on the college/university you transfer to, as well as how far in the discipline you intend to study. Please consult a counselor or the Transfer Center for further direction.

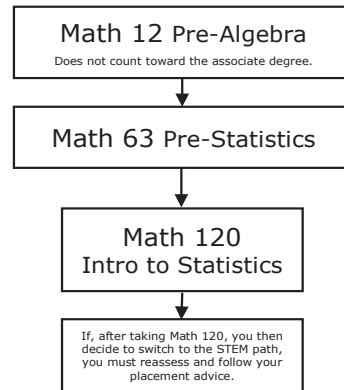

Revised 3/2017 |

Managing Your Education

ENGLISH AND READING COURSE SEQUENCE

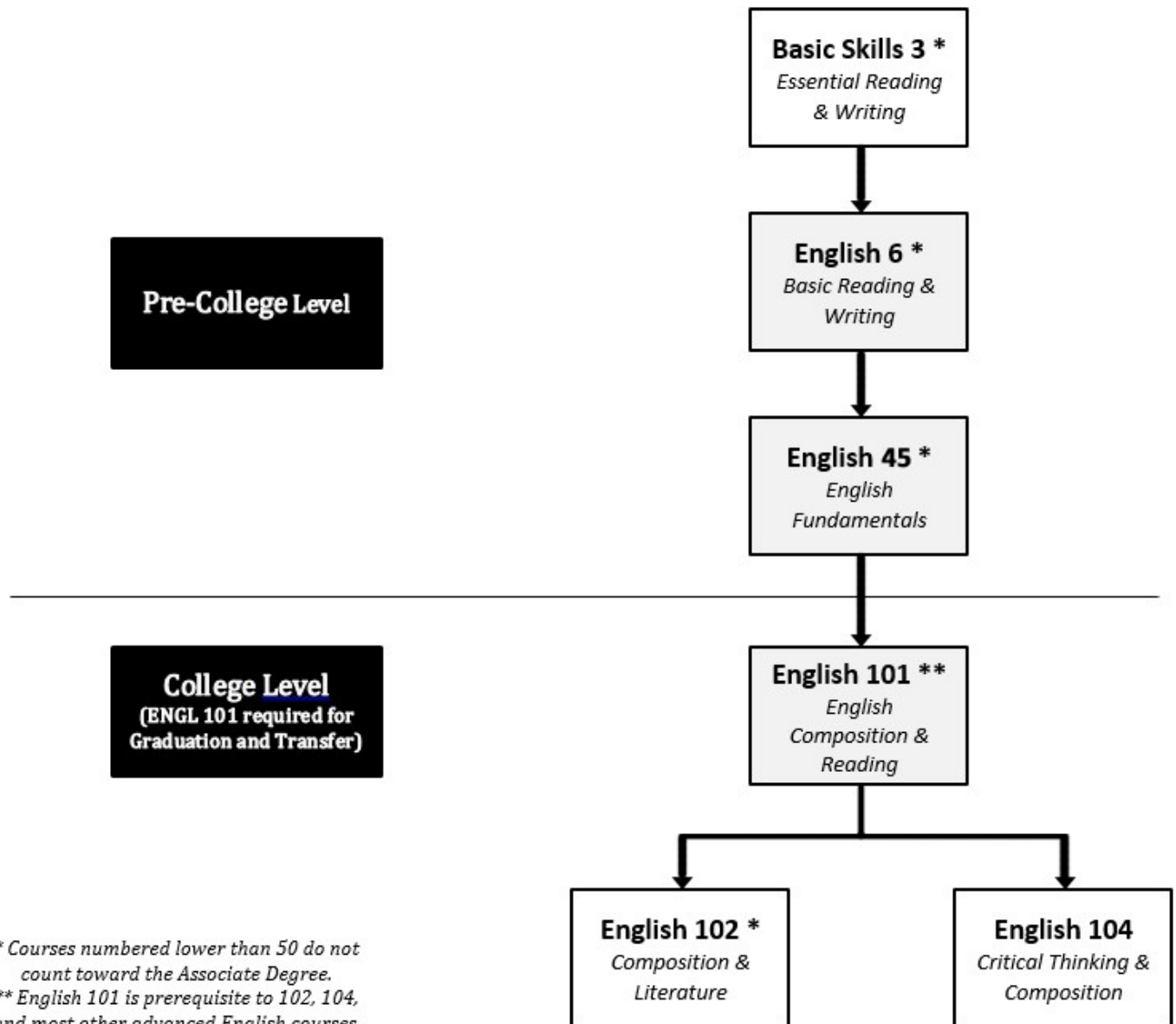

* Courses numbered lower than 50 do not count toward the Associate Degree.

** English 101 is prerequisite to 102, 104, and most other advanced English courses.

Satisfactory Standing

Each student's work is considered to be satisfactory if an average of 2.0, or "C" or better, is maintained.

Attendance

Students are expected to attend their classes regularly. FAILURE TO ATTEND THE FIRST CLASS SESSION MAY RESULT IN THE STUDENT BEING DROPPED.

Failure to attend class jeopardizes not only a student's grades but the learning potential of the other students who were unable to gain access to the class due to enrollment limits.

The class instructor has the right to terminate a student's enrollment when a student is absent for more than one hour for each unit of class credit.

Authority of Instructors - According to Education Code Section 76032, faculty members have the authority to manage their classes and classrooms and to maintain an acceptable level of conduct within each class.

Faculty may suspend students from class for up to two consecutive class meetings for misconduct which disrupts the class.

Students suspended from class may not return to class during the time they are suspended unless permission to return is granted by the instructor.

Instructors must complete an incident report on all suspensions and transmit the form to the appropriate Administrator.

Withdrawal from Class

It is the student's responsibility to initiate the withdrawal or drop procedure in a timely manner. Don't just not show up! Don't just disappear! Non-attendance does not drop the student from a class. WebAdvisor should be used to drop a class or a drop form can be completed and processed by the Admissions and Records office. Students may withdraw from classes during the first 20 percent of the class. In these situations, a "W" will not be recorded on a student's academic record.

Student-or instructor-initiated withdrawals beginning the third week and before the eighth week of semesterlength classes, or through the first 44 percent of class for other classes, will be recorded as a "W" on student transcripts. Students who do not withdraw by this time are grade obligated.

In cases of accidents, illness, or other circumstances beyond the control of the student, withdrawals may be initiated by petition after the designated time limit. Forms for this petition (which must include any applicable documentation) are available in the Office of Admissions and Records. Approved petitions will result in a "W" recorded on academic records. Please note that "W" marks approved after the designated time limit may affect financial aid. Please check with financial aid staff prior to submitting this petition to determine how it will affect you.

Academic Renewal Policy

Academic renewal is a process whereby a student's previous academic work of substandard quality is disregarded to facilitate the completion of requirements necessary for an academic degree, certificate, or transfer. A student whose current performance is demonstrably superior to a prior level of accomplishment may petition for academic renewal. The following conditions apply:

- The student may petition for academic renewal for not more than 24 semester units of work completed at VVC
- The student must submit evidence that the previously recorded work was substandard and thus not reflective of current academic ability. Any of the following criteria will be accepted as evidence of current satisfactory academic performance.
- 12-17 semester units with at least a 3.00 GPA
- 18-23 semester units with at least a 2.50 GPA
- 24 or more semester units with at least a 2.00 GPA

This more current coursework may have been completed at VVC or at other institutions.

- At least 24 months must have elapsed between the end of the semester in which the most recent disregarded academic work was completed and the submissions of the petition.

Managing Your Education

- A student may request academic renewal only once.
- Only “D,” “F,” and “NC” grades can be disregarded through academic renewal.
- The student’s permanent record is annotated to remove the “D” and/or “F” grades from the calculation of the GPA. However, all work remains legible on the permanent record to ensure a true and complete academic history.
- The student should be aware that other institutions may have different policies regarding academic renewal and may not honor this policy.

A petition and information on this policy is available from the Office of Admissions and Records.

Course Repetition

Repeatable Courses - Certain courses are repeatable for credit and are so designated in the college catalog. When a course is repeated pursuant to this section, the grade received each time shall be included for purposes of calculating the student’s grade point average.

Non-repeatable Courses (most courses are non-repeatable.)

There is a three enrollment limitation in non-repeatable courses in which a W, D, F, FW, or NP is recorded. Students who have reached the maximum number of enrollments allowed under this procedure may not re-enroll in the same course at Victor Valley College.

IF YOU ARE REPEATING A COURSE DUE TO A SUBSTANDARD GRADE OR “W” (for non-repeatable courses).

- Students may repeat the same course no more than two times in which substandard grades (“D”, “F”, “FW”, “NC”, “NP”) or “W” were assigned.
- Students may file a Petition for Course Repetition with the Admissions and Records Office to request additional repeats due to specific, extenuating circumstances.
- When repeating a course with a substandard grade the most recent grade will be computed in the cumulative grade point average. The previous grade and credit shall be disregarded in the computation of the grade point average, even if the previous grade was higher.
- When courses are repeated, the student’s permanent academic record shall clearly indicate any courses repeated and be annotated in such a manner that the record of all work remains legible, insuring a true and complete academic history. (Refer to AP4225 for additional information.)
- Petitions may be filed with the Admissions and Records Office.

IF YOU ARE REPEATING A COURSE THAT ALLOWS REPEATS, WHETHER YOU RECEIVED A GRADE OR “W”

- A course may only be repeated the number of times indicated in the catalog.
- Once a student has completed the maximum number of allowable repetitions, a student may be blocked from registering in this course. Students may file a Petition for Course Repetition with the Admissions and Records Office to request additional repeats due to verifiable extenuating circumstances.
- When a course is repeated pursuant to this section, the grade received each time shall be included for the purpose of calculating the student’s grade point average.

FOR ADDITIONAL INFORMATION, please refer to the “Managing Your Education” section of this catalog, AP4225, or contact the Admissions and Records Office.

Repetition to Alleviate Substandard Academic Work

Any non-repeatable course may be repeated when the grade earned was substandard (D, F, FW, or NP) or a non-evaluative symbol of “W” was recorded.

Upon completion of a repeated course in which a substandard grade was earned, the most recent grade will be computed in the cumulative grade point average. The previous grade and credit shall be disregarded in the computation of grade point average, even if the previous grade was higher.

Course Repetition for Satisfactory Grades (“C” or better)

A course in which a grade of “C” or better was received may not be repeated unless such repetition is provided for in the official course description or by District policy.

A Petition for Course Repetition is required for any exception to this policy. Only under specific conditions can a course be repeated in which a satisfactory grade (“C” or better) was earned or when the course was taken three times and the grade earned was substandard or a “W” was recorded. Additionally, substandard grades for repeatable courses may be alleviated. The following criteria must be met in order to qualify for an exception and be allowed to repeat a class:

- Significant Lapse of Time (defined as 36 months or more) since course was taken
- Legally Mandated Training Requirement
- Disability-Related accommodation for Disabled Students
- Extenuating Circumstances
- Significant Change in Industry or Licensure Standards A Petition for Course Repetition and additional information on this policy is available from the Admissions and Records office.

Pass/No Pass Option

Some courses may be taken on a “Pass” or “No Pass” basis, which is recorded as a “P” or “NP” on transcripts.

According to California regulations governing community colleges, a grade of “P” is not counted in calculating a student’s cumulative grade point average but is equivalent to a “C” or above. One or more grades of “NP” can be a factor in progress probation and dismissal.

For students working toward an associate degree, no more than 15 units of credit for P/NP classes or courses may be taken at Victor Valley College.

Students who plan to transfer should note that the number of P/NP courses they may transfer is determined by the policies of the particular college or university.

Students who wish to transfer have a responsibility to investigate the policies of colleges and universities in which they may be interested and to determine if particular courses taken for P/NP will be accepted for transfer credit there. Students should note that some graduate schools may not look favorably on P/NP grades.

Students who elect to take the P/NP grade option for a course should declare their intent by delivering a signed pass/no pass grade option form to the Office of Admissions and Records. The decision to take a course for P/NP may not be changed after 30 percent of the class term has passed.

The deadline for electing to take a course for P/NP is the end of the fourth week of a 16-week semester or the end of the second week for eight-week classes.

Incomplete Grades

Incomplete academic work for unforeseeable, emergency and justifiable reasons at the end of the term may result in an “I” symbol being entered in the student’s record. The condition for the removal of the “I” shall be stated by the instructor in a written record. This record shall contain the conditions for the removal of the “I” and the grade assigned in lieu of its removal. This record must be given to the student with a copy on file with the registrar until the “I” is made up or the time limit has passed. A final grade shall be assigned when the work stipulated has been completed and evaluated, or when the time limit for completing the work has passed.

The “I” may be made up no later than one year following the end of the term in which it was assigned.

The “I” symbol shall not be used in calculating units attempted nor for grade points. The governing board shall provide a process whereby a student may petition for a time extension due to unusual circumstances.

Students who receive an “I” grade cannot re-register for the same course in which they received the incomplete.

Managing Your Education

Auditing

Auditing of classes is only permitted within these provisions:

1. Cost of audit is \$15 per unit per semester.
2. Students enrolled in less than ten units will be charged the maximum audit fee allowed (\$15 per unit per semester).
3. Students enrolled in ten or more semester units will be permitted to audit up to three units at no charge.
4. Students auditing courses cannot change enrollment status to receive credit for those courses.
5. Priority in class enrollment shall be given to students desiring to take courses for credit toward degree or certificate completion.
6. Students wishing to audit courses must meet course prerequisites and matriculation requirements.

(Education Code 72252.3)

Credit by Examination

As authorized by Section 55050 of Title V of the California Administrative Code, students may apply for Credit by Examination.

After successfully completing 12 semester units of credit at Victor Valley College, a registered student may receive college credit for courses challenged through departmental examinations. These may be in subjects in which the student is qualified based on prior training and/or experience for which credit or advanced placement has not already been awarded.

Applications for this type of credit are available through Admissions and Records and must be approved first by the appropriate academic department. After credit by examination eligibility has been established, a non-refundable fee equal to the per unit enrollment fee will be charged for each administered exam, and is payable at the Bursar's Office.

Awarding credit by examination is subject to the following guidelines:

- A request for credit by examination must be submitted by the fourth week of the term (second week for Summer courses).
- The student must be enrolled in at least one course in good standing, and must have successfully completed 12 semester units of credit at Victor Valley College with a GPA of 2.00 or better.
- A faculty member must be willing to prepare an exam. If a faculty member is unavailable to prepare an exam, the challenge cannot go forward.
- Credit by examination may not be received for any course which is a prerequisite to one for which credit has been previously granted.
- In order to challenge, the student must not have previously failed the course nor have been enrolled in it during the semester for which the exam is requested.
- A student may challenge a course only once.
- Credit by examination cannot be used to satisfy Victor Valley College's 12 unit residency requirement for the Associate Degree.
- A maximum of 32 units earned through nontraditional means (CLEP, AP, DANTES, Department Exam, Military) may apply toward the Associate Degree with no more than 15 units permitted for college courses graded on a Pass/No Pass basis. This limitation does not apply to units earned at the community college of the Air Force (CCAF).
- Credit by examination will be annotated "Pass" or "No Pass" or a grade of A-F, with unit value and a notation entered on the transcript that credit was earned via "CREDIT BY EXAMINATION."

Career Technical Education (Formerly Tech Prep)

The Victor Valley College Career Technical Education (CTE) program is designed to help create pathways that lead to an associate or baccalaureate degree or a post-secondary certificate in a specific career field. Students combine high school and ROP CTE classes, real-world experience, and/or college classes, to form a balanced and practical educational experience. Within this model students are challenged to meet rigorous academic standards and experience hands-on learning in articulated secondary CTE courses.

Students graduating from high school need highly technical skills to be competitive in the job market. Up to 85% of all jobs will require at least two years of education beyond high school. A career pathway is an effective way to help students see the application of academic knowledge and makes meaningful connections between education and a variety of career options. Career pathways include career preparation recommendations for course work that prepares students to:

1. Enter directly into the workforce;
2. Continue education focused on the associate degree; or
3. Pursue baccalaureate degrees and beyond.

Benefits of Articulation

- A way to earn college credits in high school.
- A clear pathway to follow within individual career plan.
- A solid foundation of academic and technical courses.
- An introduction to the workplace.
- Assists students in the transition from high school to college.
- Direct connection to postsecondary education.
- Save time and money by not having to repeat comparable courses.
- A way to complete education and get started with a career earlier.
- Opportunity for high school and college-discipline instructors to collaborate, and develop curriculum to best prepare students for success in their career.
- Communities benefit by gaining a well trained, technically skilled workforce to meet the needs of local businesses, government agencies and industry.

For more information visit our website: www.vvc.edu/cte.

Petitions Committee

The Petitions Committee, which meets weekly when classes are in session, considers special requests from students for exemptions from certain academic, student, and college policies due to documented, extenuating circumstances. Typical requests include:

- To enroll in more than 18 units of course work during an academic semester, or more than 8 units during a summer or winter intersession.
- To drop classes after the “grade responsibility date” with a “W” grade due to extenuating circumstances
- To repeat a course

Students who petition must have valid reasons and provide appropriate documents to support their request. The burden of proof is on the student who petitions for special consideration.

The Petitions Committee has the authority to approve, deny, modify, or take no action on particular petitions which are submitted for its consideration.

Petitions are available at the Admissions and Records Office. Transfer and External Exam Credit Acceptance of Credit from Other Institutions

Managing Your Education

Transfer and External Exam Credit

Acceptance of Credit from Other Institutions

Students may use coursework completed at other institutions to fulfill program, general education, and/or elective unit requirements for the associate degree or certificate programs at Victor Valley College and for transfer to universities. To earn a Certificate of Achievement or an Associate's Degree at VVC, students must complete a minimum of 12 units of degree-applicable coursework through VVC. To earn a Certificate of Career Preparation at least 50% of the total units required must be completed through VVC. Non-degree applicable coursework will not be used to fulfill degree (including elective) requirements.

Colleges and universities must ensure the quality of their programs by adhering to specific evaluation criteria established and evaluated by private educational associations called accrediting agencies. Victor Valley College accepts courses from institutions accredited by the following regional agencies:

MSCHE - Middle States Commission on Higher Education

NEASC-CIHE - New England Association of Schools and Colleges, Commission on Institutions of Higher Education

NCA-HLC - North Central Association of Colleges and Schools, The Higher Learning Commission

NWCCU - Northwest Commission on Colleges and Universities

SACS - Southern Association of Colleges and Schools, Commission on Colleges

WASC-ACCJC - Western Association of Schools and Colleges, Accrediting Commission for Community and Junior Colleges

WASC-SCUC - Western Association of Schools and Colleges, Senior College and University Commission

Victor Valley College recognizes those institutions that are either fully accredited or are listed as a candidate for accreditation as published in the Database of Accredited Postsecondary Institutions and Programs maintained by the U.S. Department of Education.

Course Equivalency may be determined by any of the following methods:

1. Direct articulation between VVC and the sending institution.
2. Indirect articulation between VVC and other California Community Colleges based on approval of courses for the California Identification Number System (C-ID).
3. Indirect articulation between VVC and a sending institution determined by cross referencing additional public colleges and universities including in the California statewide articulation repository (ASSIST.org).
4. A critical evaluation of the course to verify core elements of the course including topics, course objectives, lecture and/or lab hours, and pre-/co-requisites are sufficiently aligned with VVC courses.

These reviews will be conducted by counselors and/or evaluations staff. Some courses will also require review by appropriate faculty content experts.

In general, credit from other institutions will be placed into similar major and general education categories at VVC as the categories into which they were applied at the issuing institution. English and Mathematics competency levels are governed by California Education Code Title 5, section 55063. The extent to which courses taken at other institutions satisfy specific

Lower division credit and subject matter will be accepted from regionally accredited institutions. Upper division coursework may fulfill subject areas for graduation but the units will not be awarded. Upper division courses will not be used to certify CSU GE or IGETC requirements.

Course applications may be approved by any of the following methods:

1. Courses completed at another California Community College that are approved for an associate degree general education category as outlined in Title 5 will be applied to the same associate degree general education category at VVC regardless of whether VVC has an equivalent course.
2. Courses completed at another California Community College or at a California State University that are approved for a CSU general education category as outlined in CSU E.O. 1065 will be applied to the parallel associate degree general education category at VVC.
3. Courses completed at private colleges and universities that are approved for a CSU general education category as outlined in CSU E.O. 1065 will be applied to the parallel associate degree general education category at VVC.
4. Courses completed at another California Community College that are approved for the Intersegmental General Education Transfer Curriculum (IGETC) as outlined in the Standards, Policies & Procedures for IGETC (version 1.7 or most current) will be applied to the parallel associate degree general education category at VVC.

Foreign Coursework

Coursework completed at foreign colleges or universities must first be evaluated by an accredited and approved evaluation service, and then reviewed by counselors or and/or evaluations staff. Some courses may also require approval by the appropriate department chair or content faculty. Courses may be used to fulfill prerequisite, program, general education and elective unit requirements only if course descriptions, in English, are submitted for review along with the evaluated foreign transcript. Course descriptions for English courses will be considered only if the language of instruction was English. Victor Valley College will not determine course transferability to other colleges and universities.

To have foreign coursework evaluated, students need to contact one of the Foreign Transcript Evaluation Services approved by the State of California Commission on Teacher Credentialing and request a detailed equivalency report that includes - for each course - a course description in English, whether it is an upper or lower division course, its U.S. semester equivalency, and the grade the student earned:

APIE	Academic & Professional International Evaluations, Inc.	www.apie.org
ACEI	Academic Credentials Evaluation Institute	www.acei-global.org
ACREVS	Academic & Credential Records, Evaluation & Verification Services	www.acrevs.com
AERC	American Education Research Corporation	www.aerc-eval.com
ECE	Educational Credential Evaluators, Inc.	www.ece.org
ERES	Educational Records Evaluation Service	www.eres.com
FCSA	Foreign Credential Services of America	www.foreigncredentials.org
FCSA-WEST	Foreign Credential Services of American West, Monterey, CA	www.foreigncredentials.org

Procedure for Evaluation of Credit from Other Institutions.

Students must submit official transcripts or documents from other institutions to the Admissions and Records Office. This includes educational transcripts, foreign transcript evaluations, military transcripts, and exams (AP, IB, DANTES, CLEP). Official transcripts or documents are required before degrees and certificates can be awarded.

Students may bring unofficial copies of the documents noted above to their counseling appointments for evaluation. Counselors can use unofficial documents to guide students and determine how the coursework will be applied toward graduation and transfer. However, these determinations are not final until official transcripts are received by Admissions & Records.

Quarter to Semester Conversion

Credit transferred in from institutions following a quarter system will be converted to semester units at VVC. The conversion is as follows: Quarter units * 2/3 = Semester units. For example, a 4 quarter unit course would equate to 2.67 semester units.

Transfer General Education Pass Along Certification

“Certification” means that Victor Valley College has verified that a student has completed the lower division, general education requirements for the university system to which they plan to transfer. Certification is important because without it students will be held to the general education requirements specific to the institution to which the student transfers. Courses from other colleges and universities may be considered for certification through a process called “pass along certification.”

Managing Your Education

CSU GE Certification

Courses taken at CSU campuses, participating private colleges and universities*, and other California Community Colleges will be certified in the subject areas (AREA A – E) approved by the institution where the courses were taken. Courses taken at other regionally accredited colleges and universities will be certified only if the course is determined to be equivalent to a course in a California Community College Certification Pattern. Courses deemed equivalent would be certified in the areas (AREA A – E) in which the equivalent courses have been approved.

*Participating private colleges and universities include: Don Bosco Technical Institute, Fashion Institute of Design and Merchandising, Humphreys College, Marymount College, and San Joaquin Valley College.

CSU GE Certification

Courses taken at other California Community Colleges will be certified in the subject areas (AREA 1 – 6) approved by the institution where the courses were taken. Courses taken at other regionally accredited colleges and universities will be certified only if the course is determined to be equivalent to a course on a California Community College IGETC Certification Pattern. Courses deemed equivalent would be certified in the subject areas in which the equivalent CCC courses have been approved.

Military Service and External Exam Credit

A maximum of 32 units earned through nontraditional means (Military Service, AP, CLEP, DANTES, VVC Credit by Exam) may apply toward the associate degree with no more than 15 units permitted for college courses graded on a Pass/No Pass basis. This limitation does not apply to units earned at the community college of the Air Force (CCAF).

Military Service Credit

Any actively enrolled student with an approved DD214 that shows completion of basic training in the Armed Services of the United States and any discharge (other than dishonorable) will be exempt from the physical education graduation requirement. An approved DD214 may also be used to fulfill the California State University 3-unit Area E General Education Breadth requirement.

In addition, credit may be granted to actively enrolled students submitting a military transcript for lower division/baccalaureate level courses completed at schools in the Armed Services of the United States and in accordance with recommendations by the American Council on Education (ACE). The number of units awarded are those units recommended by the Council in the Guide to the Evaluation of Educational Experience in the Armed Services.

Please note: the Community College of the Air Force is accredited by the Southern Association of Colleges and Schools and credit will be granted accordingly.

Advanced Placement Exams (CEEB)

Victor Valley College recognizes high achievements by students who have successfully completed one or more Advanced Placement Examinations as authorized by the College Entrance Examination Board. Students who have successfully completed exams in the Advanced Placement Program with a score of 3, 4, or 5 may be granted credit for purposes of major, general education, elective and/or to serve as prerequisites in the college's sequence of courses.

Students enrolled at Victor Valley College will automatically receive credit for Advanced Placement Examinations, if official scores are sent to the Admissions & Records office. Victor Valley College will confirm the credit granted by posting it on the unofficial VVC transcript. Please be aware that other institutions, particularly four-year colleges/universities, may evaluate Advanced Placement credits differently. Check with a counselor or the institution to which you plan to transfer for an evaluation of your Advanced Placement credits.

Refer to the following AP chart (beginning on the next page) for information on specific course credit awarded and general education areas cleared to meet VVC's program requirements as well as the transfer general education areas cleared for CSUGE and/or IGETC certification.

Managing Your Education

Advanced Placement Credit

AP Test Name	Minimum Score	VVC Equivalent Course	VVC Units Awarded	VVC Gen. Ed. Area/ Units	CSU Cert. Area	IGETC Cert. Area
Art History	3, 4, or 5	Art 101	3	Humanities/3	C1 or C2	3A or 3B
Art (Studio)						
-2D Design	3, 4, or 5	Art 112	3	Humanities/3		
-Drawing	3, 4, or 5	Art 125	3	Humanities/3		
-3D Design	3, 4, or 5	Art 113	3	Humanities/3		
Biology	3, 4, or 5	**Biol 100	4	Natural Sci./4	B2 + B3	5B w/lab
Chemistry	3, 4, or 5	Chem 100	4	Natural Sci./4	B1 + B3	5A w/lab
Chinese (See "Language and Culture")						
Computer Science						
-A Exam	4 or 5	CIS 201	4			
-AB Exam	3 or 4	CIS 201	4			
	5	CIS 201+202	8			
Economics						
-Macro	3, 4, or 5	Econ 101	3	Social/Beh./3	D2	4
-Micro	3, 4, or 5	Econ 102	3	Social/Beh./3	D2	4
English						
-Language/Comp.	3, 4, or 5	Engl 101	4	Language/4	A2	1A
-Literature/Comp.	3, 4 or 5		3	Humanities/3	C2	3B
Environmental Science	3, 4, or 5		3	Natural Sci./3	B1+B3	5A w/lab
French (See "Language and Culture")						
German (See "Language and Culture")						
Government and Politics						
-Comparative	3, 4 or 5	Pols 112	3	Social/Beh./3	*D8	4
-U. S.	3, 4 or 5	Pols 102	3	Social/Beh./3	*D8 + US-2	4 + US-2
History						
-World	3, 4, or 5	Hist 104	3	Social/Beh. or Humanities/3	C2 or D6	3B or 4
-U. S.	3, 4, or 5	Hist 117+118	6	Social/Beh. or Humanities/6	(C2 or D6)+US-1	3B or 4 +US-1
-European	3, 4, or 5	N/A	N/A	Social/Beh. or Humanities/3	C2 or D6	3B or 4
Human Geography	3, 4, or 5	Geog 102	3	Social/Beh./3	D5	4
Italian (See "Language and Culture")						
Japanese (See "Language and Culture")						

Managing Your Education

Advanced Placement Credit

AP Test Name	Minimum Score	VVC Equivalent Course	VVC Units Awarded	VVC Gen. Ed. Area/ Units	CSU Cert. Area	IGETC Cert. Area
Language and Culture						
Chinese	3, 4, or 5	French 101	3	Humanities/3	C2	LOTE + 3B
French	3, 4, or 5		5	Humanities/5		
German	3, 4, or 5		3	Humanities/3		
Italian	3, 4, or 5		3	Humanities/3		
Japanese	3, 4, or 5		3	Humanities/3		
Spanish	3, 4, or 5	Spanish 101	5	Humanities/5		
Latin	3, 4, or 5		3	Humanities/3	C2	LOTE + 3B (Only the Vergil test meets IGETC)
Math						
-Calculus AB Test or BC/AB Subscore Test	3, 4, or 5	Math 226	4	Math/4	B4	2
-Calculus BC Test	3	Math 226	4	Math/4	B4	2
	4 or 5	Math 226+227	8	Math/8	B4	2
Physics						
-Exam 1 or 2	3, 4, or 5	Phys 100	4	Natural Sci./4	B1 +B3	5A w/lab
-Exam C (Mech.)	4 or 5	Phys 221	4	Natural Sci./4	*B1 +B3	5A w/lab
-Exam C (Elec.+ Mag.)	3 or 4	Satisfies Nat. Science GE	3	Natural Sci./3	B1 +B3	5A w/lab
	5	Phys 203	4	Natural Sci./4	*B1+B3	5A w/lab
Psychology						
	4 or 5	Psyc 101	3	Social/Beh./3	*D9	4
Seminar						
	3, 4 or 5	(Elective only)	3		(Elective only)	
Spanish (Also See Language and Culture)						
Lit and Culture	3	Span 101	5	Humanities/5	C2	LOTE + 3B
	4 or 5	Span 101+102	10	Humanities/10	C2	LOTE + 3B
Statistics						
	3, 4, or 5	Math 120	4	Math/4	B4	2

*CSU Breadth Area can be certified by a passing score on this test of 3, even though a higher score is required for the VVC course equivalency.

**AP Test equivalent course will not be used in lieu of published course prerequisites for Bio 211, 221 nor 231. An appropriate college course must be completed prior to admission into these advanced biology courses.

Notes: Universities to which students transfer will apply AP test credit according to their internal policies, which may be different from VVC's policy. Contact individual universities for their local AP credit policies. Visit VVC's Transfer Center or Counseling Department for IGETC or CSU certification information or to find out more about how AP test credit will apply towards these certification patterns, as well as the VVC general education pattern.

LOTE: These courses will apply towards certification in the Language Other Than English area on the IGETC.

Last Updated 5/3/17
Senate Update Approval Date: 5/4/17

College Level Examination Program (CLEP)

The College Board, with support from the Carnegie Corporation of New York, has established the College Level Examination Program (CLEP) to evaluate, confirm, and assess college-level achievement acquired outside of the conventional academic environment. The CLEP is divided into general exams that measure college-level achievement in five basic areas of the liberal arts and over 30 subject exams measuring achievement in specific college subjects. CLEP credit is awarded in accordance with the American Council on Education (ACE) recommendations. The VVC Academic Faculty Senate, as recommended by the Academic Senate for the California Community Colleges, has endorsed the examination subject areas listed below.

<u>CLEP Examination</u>	<u>VVC GE AREAS</u>	<u>CSU GE AREAS</u>	<u>Passing Score</u>	<u>Units</u>
American Government	Social/Behavioral Science	D8	50	3
American Literature	Humanities	C2	50	3
Analyzing and Interpreting Literature	Humanities	C2	50	3
Biology	Natural Science	B2	50	3
Calculus	Mathematics	B4	50	3
Chemistry	Natural Science	B1	50	3
College Algebra	Mathematics	B4	50	3
College Algebra/Trigonometry	Mathematics	B4	50	3
French Level II**	Humanities	C2	59	3
German Level II**	Humanities	C2	60	3
History, United States I	Humanities or S/B Science	D6+US-1	50	3
History, United States II	Humanities or S/B Science	D6+US-1	50	3
Human Growth and Development	Social/Behavioral Science	E	50	3
Humanities	Humanities	C2	50	3
Introductory Psychology	Social/Behavioral Science	D	50	3
Introductory Sociology	Social/Behavioral Science	D	50	3
Natural Sciences	Natural Science	B1 or B2	50	3
Pre-Calculus	Mathematics	B4	50	3
Principles of Macroeconomics	Social/Behavioral Science	D2	50	3
Principles of Microeconomics	Social/Behavioral Science	D2	50	3
Spanish Level II**	Humanities	C2	63	3
Western Civilization I	Humanities or S/B Science	C2 or D6	50	3
Western Civilization II	Humanities or S/B Science	D6	50	3

Important Advisories:

- CLEP credit applies to areas within the Associate Degree general education pattern. **CLEP credit is not guaranteed to be used in lieu of required course prerequisites.** Submit a Prerequisite Challenge Form to the Vice President of Instruction's office, along with CLEP credit and other documentation, to have the appropriate academic department consider approving a possible exception.
- Read the "Credit by Examination" section in this catalog. A maximum of 32 units earned through non-traditional means may apply toward the Associate Degree.
- VVC's Nursing and Respiratory Therapy programs do not accept CLEP exam credit.
- Four-year colleges and universities may impose transfer limitations on credit earned through CLEP and other non-traditional means. Therefore, students who plan to transfer should consult with the transfer school to determine the transferability of credit earned by examination. The University of California does not grant credit for CLEP.
- Visit <https://clep.collegeboard.org/> to learn more and to find the nearest test centers.

CSU CLEP Policies:

All CLEP exams may be incorporated into certification of CSU GE-breadth requirements. All CSU campuses will accept the minimum units shown if the examination is included in full or subject area certification. Individual CSU campuses may choose to accept more units than those specified toward completion of general education breadth requirements and to meet minimum admission unit requirements.

Managing Your Education

****NOTE for CSU GE applicability:** If a student passes more than one CLEP test in the same language other than English (e.g., two exams in French), then only one examination may be applied to the CSU baccalaureate. For each test in a language other than English, a passing score of 50 is considered “Level I” and earns six units of baccalaureate credit; the higher score listed for each test is considered “Level II” and earns additional units of credit and placement in Area C2 of the CSU GE Breadth, as noted. (Level I = 6 units of baccalaureate credit. Level II = Placement in Area C2 of the CSU GE Breadth, plus additional credit).

US-1 - This exam only partially fulfills the CSU American Institutions graduation requirement.

UC CLEP Policies:

The University of California currently does not accept CLEP examinations.

Defense Activity for Non-Traditional Education Support (DANTES)

Victor Valley College will award credit toward the Associate Degree for suitably validated military service training including military service schools and DANTES test scores. A standard guide to the evaluation of educational experiences in the armed service is used in evaluating military service school training.

College credit earned through military service schools will appear on the student’s transcript as unit credit only, without an indication of grades. Credit evaluations are made after the student has completed at least 12 units at VVC. Successful completion of DANTES Subject Standardized Tests (DSSTs), using American Council on Education (ACE) guidelines, will result in credit applied toward the Associate Degree.

ACADEMIC STANDARDS

Probation and Dismissal Policies

VVC has specific policies governing probation, dismissal and readmission which apply to all enrolled students.,

PLEASE REFER TO THE “SERVICES FOR STUDENTS” section of this catalog, AP5055, or contact the Admissions and Records Office for additional information regarding how academic probation policies can affect your priority registration status.

LEVEL I – PROBATION

There are two forms of probation: Academic Probation and Progress Probation.

A student is placed on Academic Probation when the student has:

- Attempted at least 12 units, and
- Earned a cumulative GPA below 2.00

A student is placed on Progress Probation when the student has:

- Attempted a total of at least 12 units and, when 50 percent or more of the units attempted consist of “W,” “I,” “NC,” and/or “NP” marks recorded on the transcript.

The student is notified of their probation status by a letter encouraging students to see a counselor and/or seek other support services (i.e. Guidance classes, tutoring, etc.) to help improve academic achievement.

Clearing Probation

• Academic Probation

The student shall be cleared from Academic Probation when the student’s cumulative grade point average is 2.0 or higher.

• Progress Probation

The student shall be cleared from Progress Probation when the student’s cumulative percentage of units with “W,” “I,” “NC,” and/or “NP” drops below fifty percent.

LEVEL II – SUBJECT TO DISMISSAL

- **Academic Dismissal**

Students who have been on academic probation are “**Subject to Dismissal**” at the **end of the second consecutive semester** of enrollment when their cumulative G.P.A. continues to be below 2.0. VVC notifies students of their “**Subject to Dismissal**” status *requiring* the student to see a counselor during the current term to complete an “Academic Success Contract” and lift the Academic Hold.

- **Progress Dismissal**

Students who have been on progress probation are “**Subject to Progress Dismissal**” at the **end of the second consecutive semester** of enrollment when 50 percent or more of the units attempted consist of “W,” “I,” “NC,” and/or “NP.” VVC notifies students of their “**Subject to Progress Dismissal**” status requiring the student to see a counselor during the current term to complete an “Academic Success Contract” and lift the Academic Hold.

LEVEL III – DISMISSAL

Students who do not meet academic or progress standards for three consecutive semesters of enrollment will be dismissed from VVC for one semester. A letter will be sent informing the student of his/her dismissal status.

- **Readmission after Dismissal**

The student will be required to complete a “Petition for Reinstatement” with appropriate documentation and a copy of their prior Academic Success Contract(s) submitted to Admissions and Records. A reinstated student will be required to meet with a counselor prior to registration to develop a current “Academic Success Contract” until performance has cleared Probationary/Dismissal status.

LEVEL IV – SUBSEQUENT DISMISSAL

Students who do not meet academic or progress standards after Level III reinstatement and/or have not fulfilled the prior “Academic Success Contract(s)” will be dismissed from VVC for two semesters. A letter will be sent informing the student of his/her dismissal status.

- **Readmission after Dismissal**

The student will be required to complete a “Petition for Reinstatement” with appropriate documentation and provide a copy of ALL prior Academic Success Contract(s) submitted to Admissions and Records. A reinstated student will be required to meet with a counselor prior to registration to develop a current “Academic Success Contract” until performance has cleared Probationary/Dismissal status. Reinstated students may be dismissed for two semesters or more if performance does not improve.

A scenic campus view featuring a pond in the foreground with a small dark bird swimming. The pond is bordered by a row of light-colored rocks and tall grasses. In the middle ground, two students are sitting on a wooden bench on a green lawn. One student is wearing a white shirt and dark pants, and the other is wearing a plaid shirt and light-colored pants. In the background, there is a modern building with large windows and a black metal railing. A large tree with green leaves is on the right side of the frame.

*Financing Your
Education*

Financing Your Education

INVESTING IN YOUR EDUCATION

A college education is one of the best investments in the future that many students will make. Some experts say a college degree has the potential of adding hundreds of thousands of dollars to an individual's lifetime earnings.

In a world that is daily becoming more complex, more and more occupations require specialized training and educational and learning skills.

As with any investment, there are financial considerations in earning a college degree.

VVC offers a number of financial aid programs, scholarships, and work-study programs to help students finance their educations.

Eligibility and Qualifications

Each financial aid program has specific requirements. However, the programs described in this section of the catalog share the following eligibility criteria:

- U.S. citizenship, permanent resident visa, or California DreamAct (AB540 eligible student).
- Enrollment in courses in accordance with the VVC Educational Program Plan and regular attendance in VVC classes.
- Satisfactory academic progress (financial aid satisfactory progress policy will be given to you during the initial financial aid counseling).
- Financial need as determined by the information listed in the Free Application for Federal Student Aid (FAFSA).
- Ability to Benefit, or high school diploma.
- High School Diploma, GED, or Ability to Benefit, in some cases.
- Students must be in a valid program of study and taking classes that go toward their program. Classes taken outside of the program will not be funded!

Financial Aid

The Financial Aid Office assists students who are seeking financial help to pay for the costs of attending Victor Valley College. Money may be provided to cover the cost of tuition and/or enrollment fees, books, transportation, and partial living expenses. Students may be working and still qualify to receive financial aid. Visit www.fafsa.ed.gov for the FAFSA application. Applying on time is critical.

You may begin the FAFSA application process any time after October 1 for the upcoming year.

The processor will forward the Student Aid Report (SAR) to the student. Additional documentation may be required to support the data submitted on the application. It is important that all requested documentation be returned as soon as possible.

Financial Aid awards are not made until a student's file is complete.

The Financial Aid Office is available to help with the process. Students may find applying for aid difficult and confusing. Those needing help or advice are encouraged to contact the Financial Aid Office (760) 245-4271, extension 2277 or visit us on the Web at www.vvc.edu. We offer FAFSA Labs for those students seeking help filling out the FAFSA application. Please check online for dates and times.

TYPES OF FINANCIAL AID

Board of Governors Fee Waiver

This waiver is available to residents of California and certain AB540 eligible students to cover the additional cost due to fees initiated on July 1, 1985. Students must demonstrate financial need and complete the FAFSA or Board of Governors Fee Waiver Application. The maximum waiver covers the community college enrollment fee and discounted parking.

*NEW – Beginning Fall 2016 the Board of Governors Fee Waiver will be based on Academic/Progress Standards. Students must meet two consecutive primary terms of Academic and Progress standards in order to continue to receive the BOG fee waiver.

Please go to http://www.vvc.edu/office/student_services/keep-the-bogfw.shtml for more information.

Financing Your Education

State Grants

California, through the Student Aid Commission, offers state-funded grants for undergraduate students. There are grants for both academic and vocational higher education programs, including the new entitlement program. Cal Grant A, B or C applicants must have financial need, be legal California residents attending an eligible school in California, be in a program of study leading directly to an undergraduate degree or certificate, be enrolled at least half-time and not possess a baccalaureate degree prior to receiving an award. A student can accept only one Cal Grant. The Financial Aid Office has complete Cal Grant eligibility and application information.

Cal Grant A helps students with tuition/fee costs. The minimum eligible course length is two academic years and is held in a reserve status at the community college level.

Cal Grant B provides a living allowance for very low income students. More than half of all new Cal Grant B recipients begin at a public community college.

The Cal Grant B award for freshmen is usually limited to the non-tuition costs of attending college such as living expenses, books and supplies, transportation, etc. When renewed by sophomores and above, a Cal Grant B may also cover all or part of tuition/fee costs. The minimum eligible course length is 12 months.

Cal Grant C

helps vocational education students with tuition and training costs. Recipients must be enrolled in a vocational program at a community or independent college or a vocational school course of study from 4 to 24 months in length.

Full-Time Student Success Grant (FTSS)

Provides an additional \$600 a year for students who have either a Cal Grant B or Cal Grant C, and who are enrolled in 12 or more units.

How to Apply for State Grants

To apply for a Cal Grant, complete the Free Application for Federal Student Aid (FAFSA) and file it between October 1 and the Cal Grant March 2 deadlines. If you are a California DreamAct student you would complete the DreamAct application at www.caldreamact.org. Also complete any additional application requirements such as providing the Student Aid Commission with a verified grade point average or test scores. Community college students have until September 2 to apply for a Cal Grant B award, but earlier application is advised.

Cal Grant B Entitlement Awards

- Provides grant funds for access costs for low-income students in an amount not to exceed \$1670. This grant is to be used for living expenses and expenses related to transportation, supplies and books. Beginning with the second year of Cal Grant B benefits, Cal Grant B also helps pay for tuition/ fees for California residents attending qualifying institutions offering undergraduate academic programs of not less than one academic year.
- Awards are guaranteed for those who meet the program eligibility criteria.

General Cal Grant Eligibility Requirements

All Cal Grant applicants must:

- Be California residents
- Be U.S. citizens, eligible non-citizens, or California DreamAct (AB540 eligible student).
- Meet U.S. Selective Service requirements
- Attend an eligible California qualifying postsecondary institution
- Be enrolled at least half-time
- Maintain satisfactory academic progress as defined at school of attendance
- Have family income and assets below the established ceilings
- Not be in default on any student loan
- Not owe any federal or state grant refund

Financing Your Education

Federal Pell Grant

This is the primary grant for eligible undergraduate students it ranges from \$596 to \$5920 for the academic award year.

Federal Supplemental Educational Opportunity Grant (FSEOG)

The FSEOG is available to assist undergraduate students. The standard award is \$400 per year based upon the availability of funds. This grant is awarded to students who have a great financial need.

Return of Title IV Funds

There is a federal law about repaying money back if you leave school. If you receive any TITLE IV Funds (Pell Grant, FSEOG, Direct Loans) you may owe money back to the Federal Programs.

Here is how it works: According to the day that you withdraw, the Financial Aid Office will calculate the part of the grant that you have earned and what you may owe. NOTE: If you withdraw after you have earned 60% of your Title IV Funds, you will not owe any repayment.

Federal Work Study Program (FWS)

FWS is a form of federally funded financial aid which provides paid work experience as part of the financial aid package. If interested, please search and apply for jobs Online using the FWS link from the Financial Aid Office's website.

Bureau of Indian Affairs

The Bureau of Indian Affairs (BIA) funds a financial aid program for full-time students of American Indian descent who demonstrate financial need. To be eligible for a BIA Grant, students must be at least 25 percent American Indian, Eskimo or Aleut by blood, as recognized by a tribal group. Phone numbers to obtain applications are available from the Financial Aid Office.

Veteran's Benefits

The Veterans Service Office is located in the Veterans Resource Center (VRC) located in building 80, portables 1 and 2.

Currently we process documentation for Chapters 30, 31 (Disabled Veterans), 33 (New Post-911 GI Bill), 35 (Dependents), 1606, 1607 (Reserves). Please visit the GI Bill website at www.gibill.va.gov for information on your specific eligibility.

Veterans and eligible dependents please visit <http://vabenefits.vba.va.gov/vonapp/main.asp> to complete an application for GI Bill education. If you are already approved for benefits, you should bring a copy of your GI Bill Benefits Award Letter to Window 12/VRC and let us know that you are interested in using your benefits at Victor Valley College.

Dependents of veterans deemed 100% disabled (or deceased) from a service-connected cause, may be eligible for GI Bill benefits under Chapter 35. Dependents of veterans with a 0% or greater disability from the VA may be eligible for a tuition and fee waiver. Parents should contact the County VA Office for further details and how to apply.

The minimum grade considered "successful completion" of a course is a "D" for non-transfer or non-prerequisite classes, or a "C" for transfer or prerequisite classes, as outlined in the VVC Catalog. Students cannot receive benefits for repeating a course that was previously completed successfully.

Students assume liability for over payments of benefits; to avoid this, report any adjustments to your class load to the VRC, or call (760) 245-4271 x2245.

The VA requires that students using their GI Bill benefits, have a current GI Bill Education plan, prepared by a VVC Counselor, in their VA file. New GI Bill students have until the end of their second enrollment period to get their educational plan. Students who are changing their school of certification have one enrollment period before the ed plan is required. The ed plan must show the student's declared program and have all prior credits evaluated. When you make your appointment with a VVC counselor, please indicate that you are a GI Bill student, and bring to your meeting copies of all previous college transcripts including military.

Active duty military may be eligible for Tuition Assistance (TA) from their respective branch of service. Contact your base/post education office for TA forms and additional information.

If you have questions or need assistance, please visit our website at www.vvc.edu/veterans/ for contact information.

Financing Your Education

Scholarships and Awards

The Victor Valley College Foundation facilitates dozens of private sponsored scholarships and awards that are given to Victor Valley College students each year.

Students are invited to apply for scholarships annually from January – March for awards made to support the following academic year beginning in August. Interested students can access the Online application from the College financial aid web page or through the Foundation's website at www.vvcfoundation.com. The Foundation also posts links to scholarship opportunities from outside agencies on its website.

Eligibility requirements and award amounts vary from scholarship to scholarship. Students may be awarded based on academic excellence, financial need or other criteria established by the sponsoring organization. or questions regarding scholarships, please contact the Foundation Office.

TUITION and FEES

Students are encouraged to plan their educational budget to cover basic college costs while attending Victor Valley College: tuition, fees, books, and supplies. Fees listed are subject to change.

Enrollment Fee

Enrollment fees for California residents are set by the California Legislature for all of the state community colleges. Refer to the Admissions & Records webpage at www.vvc.edu/offices/admissions-records/fees-refund.shtml for the most up-to-date fee information. Enrollment and other fees may be refunded for full-term length classes due to program changes made during the first two weeks of a semester. Refunds for short-term classes are granted for program changes made prior to 10% of the class meetings.

A student who is a member of an active or reserve United States military service and who has withdrawn from classes due to military orders may file a petition with the district requesting refund of enrollment fees. The district will refund the entire enrollment fee unless academic credit has been awarded.

Student Center fees are refunded for students withdrawing from classes prior to the first day of the semester.

Parking fees are refunded in full after complete withdrawal from classes prior to the first day of the semester. After classes begin, no refund will be given.

A full refund will be given for ASB fees upon complete withdrawal and surrender of the ASB card prior to the first day of the semester. Parking permits and ASB cards must be surrendered upon withdrawal from school in order to receive refunds.

Refund Policy

Registration fees are refundable when a student withdraws from classes (es) by the 10% point of the length of the course for short term courses, by the end of the 4th day for winter/summer course, or by the end of the second week for full-term fall/spring semester courses. The processing fee will be deducted from the refund. No refunds will be made after the second week of instruction. Students requesting a refund will be assessed a \$10.00 service fee.

Nonresident Tuition

Students who are not considered residents of California pay all regular in-state fees plus a non-resident tuition fee, charged on the number of units taken. Refer to the current Schedule of Classes for more on charges.

Financing Your Education

AB 540 Nonresident Tuition Waiver

Any student other than a nonimmigrant alien, who meets all of the following requirements, shall be exempt for paying nonresident tuition at the California Community Colleges, the California State University and the University of California.

- The student must have attended a high school (public or private) in California for three or more years.
- The student must have graduated from a California high school or attained the equivalency in California prior to the start of the term.
- An alien student who is without lawful immigration status must file an affidavit with the college or university stating that he or she has filed an application to legalize his or her immigration status, or will file an application as soon as he or she is eligible to do so.
- Students eligible for this exemption who are transferring to another California public college or university must submit a new request (and documentation if required) to each college under consideration.
- Nonresident students meeting the criteria will be exempted from the payment of nonresident tuition, but they WILL NOT be classified as California residents. Therefore, students WILL NOT be eligible for any state supported financial aid such as the Board of Governors Waiver, CalGrant, etc.
- This exemption IS NOT available to students who are absent from California and taking distance education classes from California community colleges.

Please see Admission and Records for the Exemption Request form.

Parking Fees/ASB Fees

Parking lots located around the campus are provided for students displaying valid parking permits.

Semester permits are available from the Bursar. The parking fee is \$40 per vehicle, per semester, for the fall and spring semesters. The parking fee for Financial Aid students is \$20 per vehicle per semester. Motorcycle permits are \$5 in addition to the purchase of a vehicle permit. The parking fee for Summer/Winter is \$20 per vehicle. Parking fees are subject to change. Permits are required Monday through Saturday.

Alternative Parking Options

In addition to semester parking permits, the College offers students and visitors two alternate parking options:

1. Daily parking permits are available in vending machines located on campus (machines accept quarters only).
2. Parking meters are located in Lot #6. They are intended to meet short-term parking needs (meters accept quarters only).
Student permits are not valid in metered stalls.

Student Center Fee

During the 1992 Spring Semester, the student body approved a Student Center Fee of \$1 per semester unit, up to a maximum of \$10 per year.

Student Representation Fee

Each student is charged \$1.00 per semester (Fall/Spring). The student representation fee is authorized by Education Code Section 76060.5 and implements Title V regulations commencing with Section 54801. Section 54805 requires a notice to be provided to students stating that: "the money collected pursuant to this article shall be expended to provide support for students or representatives who may be stating their positions and view points before city, county, and district government, and before offices and agencies of the state and federal government."

Textbooks and Small Supplies

Students enrolled in classes will need textbooks and other supplies for most of the courses in which they are enrolled. The cost of textbooks purchased by the student at the beginning of each course and supplies varies from course to course. For financial planning purposes, a full-time student at Victor Valley College should plan on spending approximately \$500 per year for books and small supplies such as notebooks, pens, and pencils. Textbooks and supplies may be purchased at the college bookstore, located in the Student Activities Center (SAC) or purchased Online at www.vvcRams.com.

Textbooks may be bought back by the college bookstore at the end of the semester. A book "buy-back" is held at the bookstore during Finals Week, the last week of each regular semester. Book buy-backs are conducted on the last two days of the 6-week summer sessions.

Financing Your Education

Textbook rentals are now available at: <http://vvcrams.bookrenterstore.com/>. You can rent your textbooks for a week or for a whole semester!

The bookstore's refund policy is attached to every receipt at the time of purchase. Students should read the policy carefully to determine what may be refunded.

Fee Review

Fees are subject to review without notice due to budgetary considerations in the state legislature, the California Board of Governors, and/or the Victor Valley Community College District Board of Trustees.

Refund Policies

In the event of a withdrawal from classes, a portion of the fees paid may be refunded to the student. Refunds for withdrawals from classes must be requested by the student using a **Request For Refund** form. A \$10 processing fee will be charged for student-initiated refunds. Students not requesting refunds may apply their credit balance toward their student fees in the next semester provided the withdrawal deadlines are met.

Collection and Refund of Fees/Tuition

Collection

Prior to the start of each term, all registration fees must be paid in full within five (5) working days of registering. Beginning the first day of each term, fees must be paid within 24 hours of registration. At the Bursar's Office, acceptable forms of payment are: cash, check, money order, MasterCard, debit card, Visa, Discover and American Express. Acceptable forms of Online payment are: MasterCard, Visa, Discover and American Express.

Failure to Pay Financial Obligations:

The district may withhold grades, transcripts and diplomas, and may withhold enrollment privileges or any combination thereof from any student or former student who has been provided with written notice that he or she has failed to pay a proper financial obligation due to the District. Any item or items withheld shall be released when the student satisfactorily meets the financial obligation (California Education Code Section 72237 and AP 5030 for additional information including "Drop for Non-Payment" provisions.)

Collection when Legislature Changes Fees Following Registration

When, by an act of the Legislature, the registration fees are increased during a semester in which a student has already registered and paid fees in full, the student will be sent a bill informing them of the fee increase. The student will be allowed to continue enrollment for the semester currently in progress, but will not be given a copy of a transcript, or allowed to enroll in classes the following semester until payment for the fee increase is made in full.

Fees

THERE WILL BE NO REFUND OF PARKING FEES, ASSOCIATED STUDENT BODY FEES, STUDENT REPRESENTATION FEES, OR STUDENT USE FEES BEGINNING ON THE FIRST OFFICIAL DAY OF INSTRUCTION.

A Refund Request Form must be submitted to the Bursar's Office by the drop deadline. Please refer to the current term schedule for specific dates. A refund check will be mailed to the student within (6) to eight (8) weeks.

Students will receive a full refund for any classes cancelled by the college or from which they are administratively dropped. Refund will be processed automatically by the district. No Refund Request Form is required and the refund processing fee will be waived.



Graduation and Transfer

Graduation and Transfer

REQUIREMENTS for CERTIFICATES, DEGREES and UNIVERSITY TRANSFER

There are three academic objectives you can complete at Victor Valley College. These include:

- Occupational certificates
- Graduation with an associate's degree
- Preparation for transfer to a four-year university where you can complete a bachelor's degree

Many students elect to complete two or even all three of these goals at the same time—which you can do with careful planning.

This chapter of the catalog will tell you how to accomplish these three objectives.

Course Numbering System - Each college course has a number assigned to it, which tells you whether it applies to the associate's degree, transfers to a university, or doesn't apply to a degree.

- Courses numbered 1 through 49 are non-degree applicable (NDA), and are not intended to transfer to universities.
- Courses numbered 50 through 99 apply to the associate's degree, but do not transfer to universities.
- Courses numbered 100 through 299 apply to the associate's degree and transfer to most universities. Level 200 courses usually have prerequisites

At the end of each course description, courses that transfer to campuses of the University of California or the California State University systems are indicated by "UC" and/or "CSU."

I. OCCUPATIONAL CERTIFICATES

We'll start by telling you how to complete a certificate. This is the simplest goal, because there's not a lot to figure out. Just turn to the section entitled "Instructional Programs" for a brief overview of all the degrees and certificates offered. The following section, "Programs and Course Descriptions," specifies exactly which courses are required in order to complete the various programs.

In this section, you'll find listed the most common areas of study that people are interested in— whether VVC offers a program in that field or not. If we don't have a particular program, at least you'll probably find information about some of the institutions that do.

Under each area of study, VVC may offer a **Certificate of Achievement (CA)** which is a sequence of courses of 18 semester units or more and is awarded to students who successfully complete all the requirements for a defined program of study approved by the Victor Valley Community College Board of Trustees as well as by the Chancellor's Office for California Community Colleges. Certificates of Achievement are recorded on students' official transcripts.

Also, VVC may offer a **Certificate of Career Preparation (CP)** which is a sequence of courses fewer than 18 units and is awarded to students who successfully complete all the requirements for a defined program of study approved by the Victor Valley Community College Board of Trustees. Students who earn a Certificate of Career Preparation are presented with a paper award but the college does not record the award on students' transcripts. Students receiving a Certificate of Career Preparation must have completed all required courses with a grade point average of "C" or better, including at least 50% of the total required units in residence at VVC.

As a practical matter, if your academic skills—English, reading and math—need some refreshing, you should take courses in those areas before or along with your other courses. Refer to your Assessment printout for an idea of which courses to choose.

Graduation and Transfer

Employers of all kinds and at all levels want employees who can think well, speak well, write well, and get along with others. You can take courses at VVC in all those areas.

What many people do is complete a certificate program, then sometime later (yes, even years later!) come back to school and use those courses again as the major and often the electives for an associate's degree or even as preparation for transfer. Other people work on certificates and the requirements for a degree at the same time.

It's all up to you. Just remember: once a completed course is on your transcript, we can often use it to satisfy requirements for a second or even a third objective.

II. REQUIREMENTS FOR GRADUATION WITH AN ASSOCIATE'S DEGREE

Graduation generally requires the equivalent of two to three years of full-time study which leads to an Associate in Science (A.S.) or Associate in Arts (A.A.) degree or an Associate Degree for Transfer (A.A.-T. or A.S.-T.). For a quick listing of degrees, see the section entitled "Instructional Programs."

The college's graduation requirements allow students to earn an associate degree and, with careful planning, simultaneously meet requirements either for an occupational certificate or for some or all of the requirements for transfer to a four-year college or university, or both.

Students who wish to transfer should check with their intended institution regarding which courses meet that school's requirements.

The following discussion corresponds to the "Associate Degree Graduation Requirements" form that you will find in this Catalog a few pages from now, which is a summary of the requirements for the associates degree at VVC. This listing is also available as a worksheet at the front desk in Counseling (ask for the "green sheet"). Below are the requirements for earning AA and AS Degrees. The AA-T and AS-T degree requirements will be discussed in a later section titled "Associate Degrees for Transfer."

General Requirements

This section is a detailed listing of the requirements for the Associates Degree (A.A. or A.S.)

Note: If you're planning to transfer to a university, the key idea to keep in mind when you plan your courses for your VVC major and general education requirements is that you want to fit your transfer university's course requirements into VVC's graduation requirements; that is, use their required courses to meet VVC's degree requirements. (You'll find more on that in the Transfer part of this chapter.)

Courses for Your Major

Majors are listed in the Instructional Programs section of this Catalog. At least 18 units are required for a VVC major; each course in the major must be completed with a "C" or higher. More information about each area can be found in the departmental listing in the Programs and Course Descriptions section of this catalog. Courses used for major may not be double-counted for general education categories I-V which will be described next. Courses may be used only towards one major.

General Education

The General Education (GE) pattern at Victor Valley College is a comprehensive and integrated introduction to broadly applicable principles, concepts, and methods of :

Category I: Natural Sciences (minimum 3 semester/4 quarter units)

- Define and discuss the basic principles, concepts, and theories of the natural sciences.
- Explain and apply the methods scientists use to explore natural phenomena, including observation, hypothesis, measurement, experimentation, evaluation of evidence, and quantitative analysis. Critically evaluate the limitations, sustainability and social impact of scientific study.

Graduation and Transfer

Category II: Social and Behavioral Sciences (minimum 6 semester/8 quarter units)

Category IIA: Social and Behavioral Science

- Discuss and apply the central theoretical concepts and methods of contemporary social or behavioral science.
- Critically analyze individual or social behavior in a variety of contexts, including contemporary, historical, Western, non-Western, and minority.
- Identify and apply the principles of effective citizenship, including civility, respect for diversity, and exercise of social responsibilities.
- Explore, identify, and evaluate the factors that have shaped our global community to gain an understanding of the individual's roles in relationship to other individuals and systems on a global level.

Category IIB: American Institutions

- Identify and discuss the basic national, state and/or local political processes including the US Constitution and the rights and obligations of citizenship through responsible engagement in civic duties.

Category III: Humanities (minimum 3 semester/4 quarter units)

- Identify, discuss, and evaluate works of major philosophical, historical, literary, artistic, and/or cultural importance.
- Critically analyze conceptions of human meaning and forms of self-expression and self-understanding that represent the perspectives of different periods of time, cultures, social and ethnic groups.
- Reason effectively about values, including the application of ethical principles and ethical analysis of proposed solutions to social problems.

Category IV: Language & Rationality (minimum 6 semester/8 quarter units)

Category IVA: English Composition

- Compose a variety of essays and revise these compositions for clarity, organization, and mechanical and grammatical correctness.
- Summarize, synthesize, and paraphrase various types of source materials.
- Define, access, and evaluate research information from a variety of sources and using a variety of tools.
- Prepare documented research papers using a variety of resource material and MLA citation/documentation.

Category IVB: Communication & Analytical Thinking

- Create and deliver oral presentations that are suitable to the topic, purpose, and audience.
- Communicate orally with civility and attention to diversity using a wide range of media and in a variety of settings.
- Actively listen with literal and critical comprehension of ideas and information transmitted in oral language.

Category V: Mathematics (minimum 3 semester/4 quarter units)

- Communicate mathematical concepts formally, using appropriate notation and terminology, and informally by using everyday language.
- Effectively organize, present, interpret and summarize quantitative information using symbolic, numerical and graphical methods.
- Solve problems by evaluating the available information and type of problem, choosing an appropriate technique, applying the technique, and verifying whether or not the solution is reasonable.
- Use mathematical concepts and methods to understand, analyze, and express applications in quantitative terms.

Competencies

Information Competency

- Determine the nature and extent of information needed and identify a variety of types of potential sources of information.
 - Utilize research tools and/or the Internet to effectively locate and retrieve information resources.
 - Analyze and evaluate information using the criteria of credibility, relevance, authority, currency, and point of view or bias.
 - Organize and communicate information for a specific purpose and in accordance with legal and academic standards.
 - Demonstrated by successful completion of English 101/English 1A Information Competency component at Victor Valley College (VVC) with a minimum score of 70% OR successful completion of the VVC Library Information
 - Competency project with a minimum score of 70% when English 101 equivalent was completed at another college. AP
- 2017-2018 Victor Valley College Catalog

Graduation and Transfer

exam credit does not fulfill the Information Competency requirement.

Global Citizenship

- Explore, identify, and evaluate the factors that have shaped our global community to gain an understanding of the individual's roles in relationship to other individuals and systems on a global level.
- Demonstrated by successful completion of underlined courses in General Education Category II (A) Social and Behavioral Sciences and Category III Humanities. A non-general education course POLS 221 Model United Nations also fulfills Global Citizenship.

Requirements

At least 21 semester units are required for your GE. The list later in this section shows each course that can be used to satisfy GE requirements. It's a good idea to make your selections with an eye to your transfer requirements—see lists of transfer requirements later in this chapter.

Physical Education/Kinesiology (PE)

At least one unit in an activity or non-activity (lecture) course in Physical Education/Kinesiology is required of all students who wish to earn the associate degree. A maximum of 4 units of PE/KIN activity courses will count toward the degree (except for PED/KIND units in the Fine Arts major, which have no limitation).

Having completed military basic training usually fulfills this requirement; a copy of the student's form DD214 or other documentation must be on file with the Office of Admissions. Health 102 and Kinesiology 103, which may have been used to fulfill other major or GE areas may simultaneously satisfy the PE requirement. Courses listed under Athletics do not satisfy the requirement.

Electives

The remaining units for the degree—approximately 21—are called electives, because after satisfying your major and GE requirements, you may elect to take whatever you like, with some restrictions and recommendations. For example, you might want to complete courses towards an occupational certificate or towards possible transfer objectives.

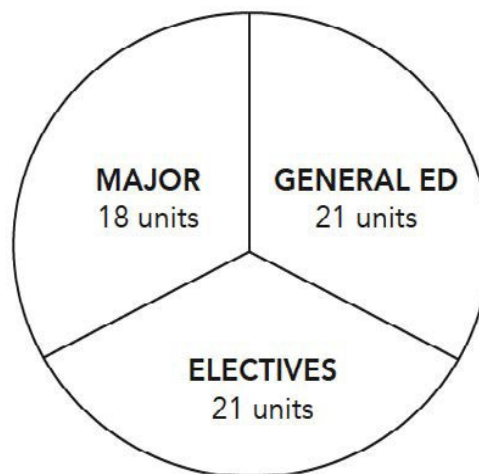

DISTRIBUTION OF UNITS
FOR THE AA/AS DEGREE

Catalog Rights for Associate Degree, Certificate, or Transfer Requirements

The term "catalog rights" refers to the requirements, rules and regulations found in the Victor Valley College Catalog for a specific academic year defining specific requirements, as established in the catalog, which the student must satisfy to qualify for an associate degree, a certificate, or transfer. An absence of not more than two years due to an approved educational leave, or to attend another college or university, is not considered an interruption in attendance. Catalog rights apply for a maximum of six years prior to graduation for students in continuous enrollment.

Graduation and Transfer

Continuous Enrollment

Degree, certificate, and/or transfer requirements may change from one catalog year to the next. Students have the right to complete requirements under the terms of any catalogs that are published while in continuous enrollment. Continuous enrollment is defined as enrollment in at least one transcribed, credit course in at least one semester, Fall or Spring, during an academic year.

Students who initially enroll or re-enroll during summer session may choose to have catalog rights for the previous academic year.

Students who do not meet the continuous enrollment condition specified above, and who re-enroll in the college, will fall under the catalog requirements for the academic year when re-enrolling in VVC.

Consequences of not being continuously enrolled include loss of priority registration. Possible additional consequences may include:

- Changes in requirements for a certificate
- Changes in requirements for an Associate Degree
- Discontinuation of programs
- Changes in admission and/or general education requirements for transfer to a University.

Application for Graduation

Graduation ceremonies are held once a year in June. The graduating student is responsible for filing with the Office of Admissions and Records an application for graduation, which includes submitting all transcripts from other colleges and all other documents verifying completion of any requirements. Students applying for an Associate Degree or Certificate do not have to be currently enrolled. Students must apply within three years from the date all requirements are satisfied. Exceptions, for example, medical reasons or military service, should be submitted in writing including supporting documentation, to the Director of Admissions and Records *Deadlines are as follows:*

The deadline to apply for graduation or for an occupational certificate is the last day of the term prior to the term in which you expect to graduate. Apply by the end of Fall semester to graduate in Spring. Apply by the end of Spring semester to graduate in Summer. Apply by the end of the Summer term to graduate in Fall. There is no graduation in Winter. You may download the graduation application at <http://www.vvc.edu/forms/>.

Second and Subsequent Degrees

To earn more than one Associate Degree, AA/AS the following apply:

1. Students must complete an additional 18 units from an approved departmental major for each additional degree.
2. No courses used in the major for one degree may be used in the major for a subsequent degree.
3. The general education requirements used for the first degree remain as the general education requirements for subsequent degrees.
4. These do not apply when earning an AA -T/AS -T degree. See Associate Degrees for Transfer section.

Graduation and Transfer

VICTOR VALLEY COLLEGE ASSOCIATE DEGREE GRADUATION REQUIREMENTS 2017-2018

Requirements for Graduation.....minimum 60 semester units

1. Complete 60 degree-applicable units (courses numbered 50 and above), not to include more than 4 units of physical activity (kinesiology).
2. Earn a cumulative GPA of 2.0 or higher in all degree-applicable units including all units from other colleges attended, if applicable.
3. Complete at least 12 units at Victor Valley College.
4. Complete appropriate units for the major, general education categories, and other graduation requirements including kinesiology, global citizenship, and information competency.
5. Courses may count in one area only, either the major or a general education category. However, a course that has been used in a major or general education category may also satisfy another graduation requirement (i.e. kinesiology, global citizenship, and information competency). Courses counted in one AA or AS major may not be counted in a second AA or AS major.
6. Have official transcripts from other colleges attended, military credit, and AP or CLEP scores sent to VVC. Students are responsible for furnishing official transcripts. Final evaluation and acceptance of transfer courses taken at other regionally accredited colleges will be determined by the Registrar's Office at the time the student's graduation application is evaluated. VVC may not accept credits from all institutions of higher education.
7. Apply for graduation before the deadline. Visit <http://www.vvc.edu/offices/admissions-records/graduation.shtml> for more information and forms.

DO NOT USE THIS SHEET FOR AA-T OR AS-T DEGREES; SEE A COUNSELOR OR VISIT WWW.ADEGREEWITHAGUARANTEECOM FOR MORE INFO

MAJOR.....minimum 18 semester units

See reverse for a list of Associate Degree majors. All courses in the major must be completed with a "C" grade or better. Major courses may not be double-counted with VVC GES.

LEGEND: C = COMPLETED UNITS; IP = IN PROGRESS UNITS; N = NEEDED UNITS

Major course	C	IP	N	Major course	C	IP	N	Major course	C	IP	N

GENERAL EDUCATION (GE)minimum 21 semester units

Category I: Natural Sciences.....minimum 3 semester / 4 quarter units AGNR 123, 170; ANTH 101, 101L; ASTR 101; BIOL 100, 107, 118, 201, 202, 203, 210, 211, 221, 231; CHEM 100, 201, 202, 206, 207, 281, 282; GEOG 101, 101L, 130; GEOL 101; HLTH 102; OCEA 101; PSCI 101; PHYS 100, 201, 202, 203, 204, 221, 222; PSYC 109	
Category II: Social and Behavioral Sciences.....minimum 6 semester / 8 quarter units Complete one course from Group A and one course from Group B A. AGNR 175, 178; AJ 101; ANTH 101, 102, 103, 105, 106; CHDV 100, 106; CMST 105 (Intercultural); ECON 101, 102; ENGL 234; GEOG 101, 102, 103, 104; GUID 101, 105, 107; HIST 103, 104, 115, 117/H117, 118/H118, 130, 131, 155, 157; KIN 104; PHIL 114*; POLS 101, 102/H102, 103, 104, 110, 112, 113, 114*, 206, 211; PSYC 101, 110, 111, 121, 125, 133, 204, 213; RLST 113, 115; SOC 101, 102, 103, 107 B. American Institutions Any of the following will also satisfy one of CSU's <i>US History, Constitution and American Ideals</i> requirements: HIST 117/117H, 118/118H, 155, or POLS 102/102H. (HIST 115 and POLS 103 are OK, but do not satisfy the CSU requirement.)	
Category III: Humanities.....minimum 3 semester / 4 quarter units ANTH 106; ART 101, 102, 104, 105, 106, 107, 108, 109, 112, 113, 114, 120, 122, 125, 150; CART 133; CMST 105 (Intercultural); ENGL 102/H102, 109, 116*, 220, 225, 230, 231, 232, 233, 234, 235, 240, 241, 245, 246, 247; HIST 103, 104, 115, 117/H117, 118/H118, 130, 131, 155, 157; KIN 103 (History of Dance); MUSC 100, 101, 102, 103, 116, 117, 118, 131, 202, 204; PHIL 101, 108, 114*, 117*, 120, 121; POLS 114*; RLST 101, 105, 106, 110, 111, 115, 117*; TA 101, 102, 104, 107, 110, 116* Languages: ASL 122, 123, 124, 125; FREN 101, 102, 103, 104; SPAN 101, 101A, 101B, 102, 103, 104	
Category IV: Language & Rationality.....minimum 6 semester / 8 quarter units Complete one course from Group A and one course from Group B Note: Courses in Category IV must be completed with grade of "C" or better. A. English Composition ENGL 101/H101 This course fulfills the Information Competency graduation requirement. If you took English Composition at another college, you must complete the Information Competency assessment given at the VVC Library. B. Communication & Analytical Thinking ENGL 102/H102, 104/H104; PHIL 109, 207*; RLST 207*; CMST 106, 107, 108, 109	
Category V: Mathematicsminimum 3 semester / 4 quarter units Note: Course in Category V must be completed with grade of "C" or better. MATH 90, 90S, 104, 105/105H, 116, 120/120H, 132, 226/226H, 227/227H, 228/228H, 231, 270; PSYC 215	

KINESIOLOGY (formerly Physical Education)... A minimum of 1 semester unit is required. This requirement can be fulfilled by any of the following: Any APE, KIN, KIND course; TA courses that are cross-listed with KIND; the HLTH 102 course; or completion of military basic training Athletics courses do not fulfill this requirement.	
ELECTIVES... Degree-applicable courses that have not been used to fulfill other requirements above, which bring the total to 60 units minimum.	

Competencies: **Global Citizenship** (underlined courses; see catalog for additional options) **Information Competency** (see category IV-A).
 These competencies are normally satisfied within the 60 units required for the degree.

*Cross-listed courses are the same course listed under different departments: ENGL 116 = TA 116; PHIL 114 = POLS 114; PHIL 117 = RLST 117; and PHIL 207 = RLST 207.

Graduation and Transfer

VICTOR VALLEY COLLEGE Associate Degree Majors

Associate in Science (AS) degrees are awarded in **Math/Science** and various technical areas;
Associate in Arts (AA) degrees are awarded in the areas of **Liberal Arts** and **Fine Arts**;
Associate Degrees for Transfer (AA-T, AS-T) are offered as shown below.

All majors require at least 18 units; some have specific course requirements.
Courses numbered 138 (e.g., AUTO 138) only apply as electives, not in a major.

Administration of Justice, AS, AS-T¹
Automotive Technology, AS
Aviation Maintenance Technology, AS
Business, AS
Business Administration, AS
Business Education Technologies, AS
Business Real Estate and Escrow, AS
Child Development, AS²
Communication Studies, AA-T¹
Computer Information Systems, AS
Computer Integrated Design and Graphics, AS
Construction and Manufacturing Technology, AS²
Early Childhood Education, AS-T¹
Electronics and Computer Technology, AS
Electronics Engineering Technology, AS²
Emergency Medical Services, AS^{2,3}
English, AA-T¹

Environmental Horticulture, AS⁴
Fine Arts, AA (see below)
Fire Technology, AS
Geography, AA-T¹
History, AA-T¹
Kinesiology, AA-T¹
Liberal Arts, AA (see separate sheet)
Mathematics, AS-T¹
Math/Science, AS (see below)
Medical Assistant, AS²
Nursing, AS^{2,3}
Political Science, AA-T¹
Psychology, AA-T¹
Respiratory Therapy, AS^{2,3}
Restaurant Management, AS²
Sociology, AA-T¹
Welding, AS

¹Associate Degree for Transfer – requires specific coursework. See College Catalog for more information.

²Requires specific courses and more than 18 units to fulfill major. See College Catalog for more information.

³Requires application and admission to the program. ⁴Formerly Agriculture and Natural Resources.

Fine Arts Major (AA)

minimum 18 semester units

To earn an Associate in Arts degree with a major in Fine Arts, complete a minimum of 18 units chosen from any of the following courses. Note that the 4-unit physical activity (KIN/KIND/TA) limitation does not apply in this major.

- **ANTHROPOLOGY:** ANTH 151
- **ART:** ART 101, 102, 104, 105, 106, 107, 108, 109, 112, 113, 114, 115, 120, 121, 122, 123, 124, 125, 126, 128, 129, 131, 132, 134, 135, 141, 142, 150, 151; CART 133
- **MUSIC:** MUSC 100, 101, 102, 103, 104, 105, 110, 111, 116, 117, 118, 120A-J, 122, 123, 124, 125, 126, 128, 129, 130, 131, 132, 134A, 135, 136, 139, 140, 141, 143, 144, 145, 147, 202, 203, 204, 205, 210, 211, 220AB, 222, 223
- **KINESIOLOGY/DANCE:** KIN 103; KIND 160ABC, 161ABC, 162ABC, 163AB, 166ABC, 167ABC, 169ABC, 170ABC, 171ABC, 174ABCD, 175ABCD, 176ABCD, 180, 182, 183
- **PHOTOGRAPHY:** PHOT 52, 53, 54, 100, 101, 103, 105, 106, 129
- **THEATRE ARTS:** ENGL 116*; TA 101, 102, 104, 106, 107, 109, 110, 111, 113, 115, 115.1, 115.2, 115.3, 115.4, 116*, 117, 120, 128, 129, 160ABC, 161ABC, 166ABC, 167ABC, 170ABC, 171ABC, 174A, 175A, 180, 182, 183

*Cross-listed courses are the same course listed under different departments: ENGL 116 = TA 116

Math/Science Major (AS)

minimum 18 semester units

To earn an Associate in Science degree with a major in Math/Science, complete a minimum of 18 units chosen from any of the following courses:

- **MATHEMATICS:** ELCT 57, 58, 59, 60; MATH 104, 105/H105, 116, 120/H120, 129, 132, 226/H226, 227/H227, 228/H228, 231, 270; PSYC 215
- **LIFE SCIENCES:** ANTH 101, 101L; BIOL 100, 107, 110, 118, 201, 202, 203, 210, 211, 213, 215, 221, 231, 233; HLTH 102
- **PHYSICAL SCIENCES:** AGNR 123, 170; ASTR 101; CHEM 100, 128, 201, 202, 206, 207, 281, 282; GEOG 101, 101L, 103, 130; GEOL 101, 128, 129; OCEA 101; PSCI 101, 128; PHYS 100, 128, 129, 201, 202, 203, 204, 221, 222; RMGT 120

To earn a second Associate Degree (AA or AS), the General Education courses remain the same, but you must complete an additional 18 units in the new major, paying attention to any specific requirements for that major.

To transfer to a university for a Bachelor's Degree, choose courses for your Associate's Degree that simultaneously satisfy your university's lower division requirements. To transfer to the University of California (UC) or to the California State University (CSU), you will most likely want to complete the Intersegmental General Education Transfer Curriculum (IGETC) or, for CSU only, the General Education Requirements for Transfer Certification (CSUGE), as part of your Associate's Degree. Visit the Transfer Center and www.assist.org for more information about preparing for transfer. Also, ask about the "Associate Degree for Transfer."

Graduation and Transfer

The Student Transfer Achievement Reform Act (Senate Bill 1440, now codified in California Education Code sections 66746-66749) guarantees admission to a California State University (CSU) campus for any community college student who completes an “associate degree for transfer,” a newly established variation of the associate degrees traditionally offered at a California community college. The Associate in Arts for Transfer (AA-T) and the Associate in Science for Transfer (AS-T) are intended for students who plan to complete a bachelor’s degree in a similar major at a CSU campus. Students completing these degrees (AA-T or AS-T) are guaranteed admission to the CSU system, though not to a particular campus or major. Students transferring to a CSU campus that accepts the AA-T or AS-T will be required to complete no more than 60 semester units after transfer to earn a bachelor’s degree (unless the major is a designated “high-unit” major). This degree may not be the best option for students intending to transfer to a particular CSU campus or to a university or college that is not part of the CSU system. Students should consult with a counselor when planning to complete the degree for more information on university admission and transfer requirements.



The following are required for all AA-T and AS-T degrees:

1. Completion of a minimum of 60 CSU-transferable semester units.
2. Minimum grade point average (GPA) of at least 2.0 in all CSU-transferable coursework. (While a minimum of 2.0 is required for admission, some majors may require a higher GPA. Please consult with a counselor for more information.)
3. Completion of a minimum of 18 semester units with a “C” or better (or a “P” if the course is taken on a (“pass-no pass basis”)) in all courses required as part of a AA-T or AS-T major as identified by the college catalog.
4. Completion of the California State University General Education-Breadth pattern (CSU GE Breadth) OR the Intersegmental General Education Transfer Curriculum (IGETC) pattern general education requirements. (See pages to follow in the catalog for more information.)

VVC offers several Associate Degrees for transfer. To view the most current list of VVC’s Associate Degrees for Transfer and to find out which CSU campuses accept each degree, please go to <http://www.calstate.edu/transfer/adt-search/search.shtml> and use the search tool.

Current and prospective community college students are encouraged to meet with a counselor to review their options for transfer and to develop an educational plan that best meets their goals and needs.

To earn an AA-T or AS-T degree, the major coursework listed in the “Programs and Course Descriptions” section, plus either the CSU General Education requirements or the Intersegmental General Education Transfer Curriculum (IGETC). You may double count a listed class in both the major and the transfer GE patterns. Students must meet all the requirements listed above and 12 units residency at VVC. Course work transferred in from the other California Community Colleges will be applied toward the ADT major and CSU-GE/IGETC areas to fulfill the same requirements as they would have at the previous institution

A student may use major courses in both a traditional Associate’s Degree and in an Associate’s Degree for Transfer (ADT). For example, a student who completed an AA in Liberal Arts degree with an emphasis in Social/Behavioral Science may use the relevant SOC and PSYC courses to meet the requirements of the AA-T in Sociology. Likewise, if a student completed the AA-T in Sociology, the relevant major courses could be used for the AA in Liberal Arts with an emphasis in Social/Behavioral Science degree. A student may earn more than one ADT. It is up to the student to decide which to use when applying to the CSU system for transfer. A student could use one ADT major for applying to one CSU and a different ADT major for applying to a different CSU.

Currently VVC offers the following ADT majors:

- Administration of Justice
- Communication Studies
- Early Childhood Education
- English
- Geography
- History
- Kinesiology
- Mathematic
- Political Science
- Psychology
- Sociology

Graduation and Transfer

Course Identification Numbering System (C-ID)

The Course Identification Numbering System (C-ID) is a statewide numbering system independent from the course numbers assigned by local California community colleges. A C-ID number next to a course signals that participating California colleges and universities have determined that courses offered by other California community colleges are comparable in content and scope to courses offered on their own campuses, regardless of their unique titles or local course number. Thus, if a schedule of classes or catalog lists a course bearing a C-ID number, for example COMM 110, students at that college can be assured that it will be accepted in lieu of a course bearing the C-ID COMM 110 designation at another community college. In other words, the C-ID designation can be used to identify comparable courses at different community colleges. However, students should always go to www.assist.org to confirm how each college's course will be accepted at a particular four-year college or university for transfer credit.

The C-ID numbering system is useful for students attending more than one community college and is applied to many of the transferable courses students need as preparation for transfer. Because these course requirements may change and because courses may be modified and qualified for or deleted from the C-ID database, students should always check with a counselor to determine how C-ID designated courses fit into their educational plans for transfer.

Students may consult the ASSIST database at www.assist.org for specific information on C-ID course designations. Counselors can help students interpret this information.

This table shows which California State University (CSU) campuses accept which degrees. Students completing an AA-T or AS-T degree are guaranteed admission to a CSU campus, as long as they complete 60 transferable units, including the pre-major requirements and the CSU General Education (GE) or IGETC General Education pattern, and maintain a transferable cumulative GPA of at least a 2.0.

For more information on AA-T/AS-T degrees, including any new ones, please meet with a counselor or visit www.adegreewithaguarantee.com

**A student wishing to pursue an AA-T/AS-T degree in any one of the above majors must ensure the CSU of their choice is accepting that similar major (see above). Students completing an AA-T/AS-T degree are guaranteed admissions into a CSU campus given that a student fulfills the following: 1) 60 CSU transferable units; 2) Completes the CSU General Education (GE) or IGETC General Education pattern; 3) Completes the major requirements for the AA-T/AS-T; 4) Maintains a minimum 2.0 transferable cumulative GPA (C or better); 5) Completes the Basic/Golden 4 GE requirements. For more information on the AA-T/AS-T degrees, meet with a counselor or visit www.adegreewithaguarantee.com.*

SB 1440 (AA-T/AS-T) VVC/CSU Similar Degrees*

CSU Campus	AS-T: Administration of Justice	AA-T: Communication Studies	AS-T: Early Childhood Education	AA-T: English	AA-T: Geography	AA-T: History	AS-T: Math	AA-T: Political Science	AA-T: Psychology	AA-T: Sociology
Bakersfield	Yes	Yes	Yes	Yes	No	Yes	Yes	Yes	Yes	Yes
Channel Island	No	Yes	Yes	Yes	No	Yes	Yes	Yes	Yes	Yes
Chico	Yes	Yes	Yes	Yes	Yes	Yes	Yes	Yes	Yes	Yes
Dominguez Hills	No	No	Yes	Yes	Yes	Yes	Yes	Yes	Yes	Yes
East Bay	Yes	Yes	Yes	Yes	Yes	Yes	Yes	Yes	Yes	Yes
Fresno	Yes	Yes	Yes	Yes	Yes	Yes	Yes	Yes	Yes	Yes
Fullerton	Yes	Yes	Yes	Yes	Yes	Yes	Yes	Yes	Yes	Yes
Humboldt	Yes	Yes	Yes	Yes	Yes	Yes	Yes	Yes	Yes	Yes
Long Beach	Yes	Yes	Yes	Yes	Yes	Yes	Yes	Yes	Yes	Yes
Los Angeles	Yes	Yes	Yes	Yes	Yes	Yes	No	Yes	Yes	Yes
Maritime Academy	No	No	No	No	No	No	No	Yes	No	No
Monterey Bay	No	Yes	Yes	Yes	Yes	Yes	Yes	Yes	Yes	Yes
Northridge	Yes	Yes	Yes	Yes	Yes	Yes	Yes	Yes	Yes	Yes
Pomona	No	Yes	Yes	Yes	Yes	Yes	Yes	Yes	Yes	Yes
Sacramento	Yes	Yes	Yes	Yes	Yes	Yes	Yes	Yes	Yes	Yes
San Bernardino	Yes	Yes	No	Yes	Yes	Yes	Yes	Yes	Yes	Yes
San Diego	Yes	Yes	No	Yes	Yes	Yes	Yes	Yes	Yes	Yes
San Francisco	Yes	Yes	Yes	Yes	Yes	Yes	Yes	Yes	Yes	Yes
San Jose	Yes	Yes	Yes	Yes	Yes	Yes	Yes	Yes	Yes	Yes
San Luis Obispo	No	No	No	Yes	Yes	Yes	No	Yes	No	No
San Marcos	No	Yes	No	Yes	No	Yes	Yes	Yes	Yes	Yes
Sonoma	Yes	Yes	Yes	Yes	Yes	Yes	Yes	Yes	Yes	Yes
Stanislaus	Yes	Yes	Yes	Yes	Yes	Yes	Yes	Yes	Yes	Yes

* A student wishing to pursue an AA-T/AS-T degree in any one of the above majors must ensure the CSU of their choice is accepting that similar major (see above). Students completing an AA-T/AS-T degree are guaranteed admissions into a CSU campus given that a student fulfills the following: **1) 60 CSU transferable units; 2) Completes the CSU General Education (GE) or IGETC General Education pattern; 3) Completes the major requirements for the AA-T/AS-T; 4) Maintains a minimum 2.0 transferable cumulative GPA (C or better); 5) Completes the Basic/Golden 4 GE requirements.** For more information on the AA-T/AS-T degrees, meet with a counselor or visit www.sb1440.org and www.adegreewithaguarantee.com.

Rev. 4.25.17

Graduation and Transfer

III. TRANSFERRING TO A FOUR-YEAR COLLEGE OR UNIVERSITY

VVC transfers about 650 students annually to campuses of the University of California, California State University, various private schools, and out-of-state universities. These students traditionally do as well as or better than students who began as freshmen at the four-year college.

Students can generally complete the freshman and sophomore level coursework towards a bachelor's degree at a community college, like VVC, while simultaneously earning an associate's degree. For an overview of the courses you need to take at VVC in order to satisfy requirements at your intended transfer institution, find your major in this catalog. Find out more specific information about transferring at: www.assist.org. Consult with a counselor, with VVC's Transfer Center and/or, of course, with the transfer institution itself.

There are four basic types of universities or four-year schools to which community college students transfer: The University of California (UC) system, the California State University (CSU) system, private institutions, and out-of-state institutions.

UNIVERSITY OF CALIFORNIA (UC)

The UC system is world-renowned for its excellence in teaching and, in particular, research into what makes the world the way it is. Each of the ten campuses statewide (nine undergraduate) has its own distinct academic and social character, but all offer intellectually challenging bachelor's, master's and doctoral programs in an academically rigorous environment. The next few pages have more information on the UC system.

CALIFORNIA STATE UNIVERSITY (CSU)

The twenty-three campuses of the CSU system offer a wide variety of innovative and exciting bachelor's and graduate-level programs whose goal is to prepare citizens for effective participation in society. As with the UC system, each campus has its own "flavor," but all offer well-regarded programs, many of which are internationally prominent. Find more information on the CSU system later in this chapter.

PRIVATE AND OUT-OF-STATE INSTITUTIONS

Private schools such as the University of Southern California (USC) or Pepperdine University, and out-of-state institutions, such as University of Nevada at Las Vegas (UNLV) or Arizona State University (ASU), are some of those to which VVC students transfer. Such institutions are geographically and figuratively "all over the map," and students are advised to consult them directly. Visit the Transfer Center for more information.

NONTRADITIONAL DEGREE PROGRAMS

A number of nontraditional bachelors and graduate-level programs are offered by accredited institutions. These programs are designed for people whose distance, work or family situations prevent them from regular attendance in more traditional programs. Visit the Transfer Center for more information. Also, please see the page on College Accreditation at the end of this section.

OF SPECIAL INTEREST

Many students are interested in transferring to universities designated under the following categories:

Historically Black Colleges and Universities (HBCU)

<http://www.ed.gov/edblogs/whhbcu>

<http://extranet.cccco.edu/HBCUTransfer.aspx>

Hispanic Serving Institutions (HSI)

http://www.hacu.net/hacu/HSI_Definition.asp

http://www.hacu.net/assnfe/companydirectory.asp?STYLE=2&COMPANY_TYPE=1,5

Tribal Colleges and Universities

<http://sites.ed.gov/whiaiane/tribes-tcus/tribal-colleges-and-universities/>

Please visit these websites for more information

Graduation and Transfer

The University of California - 10 Campuses

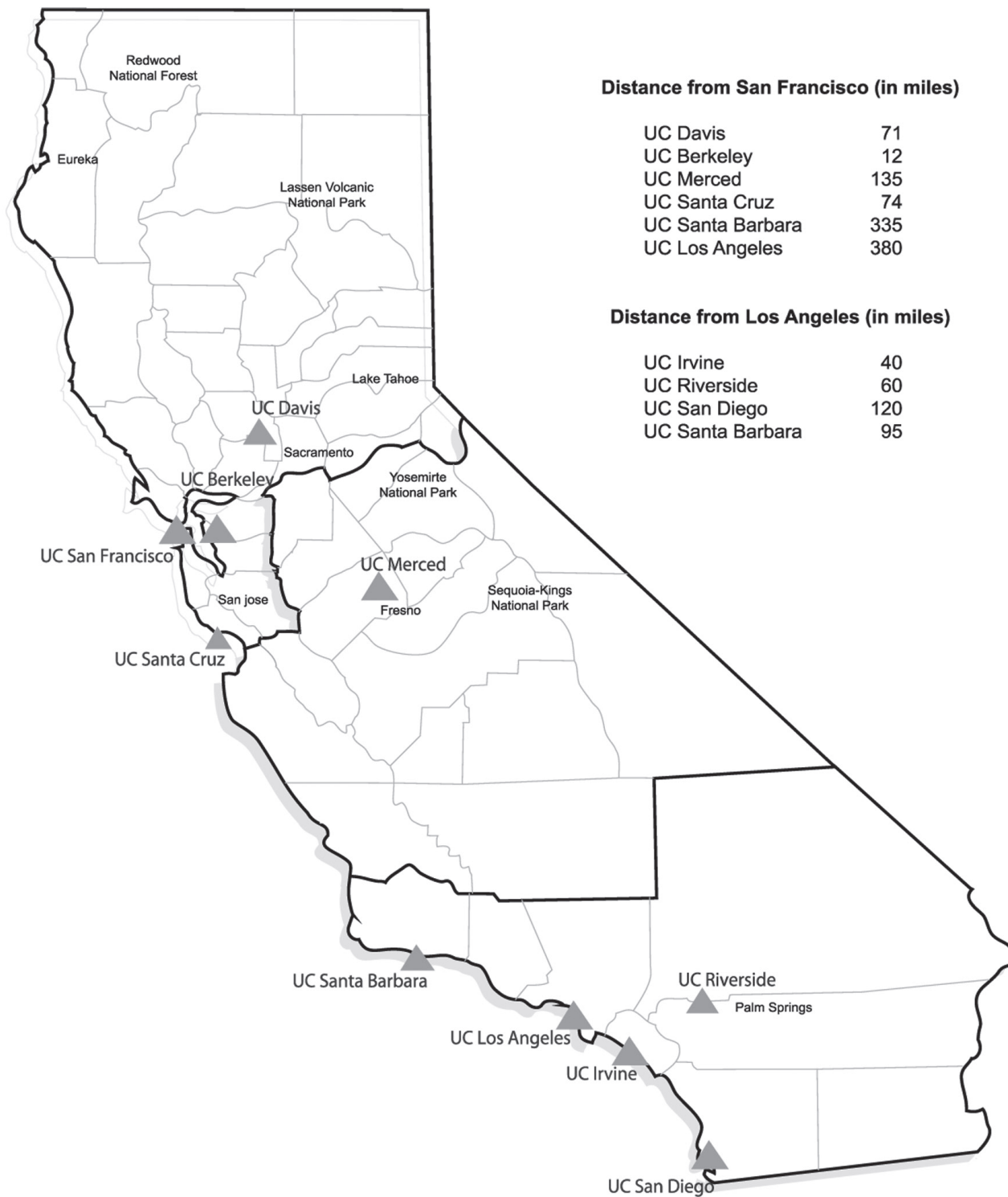

Graduation and Transfer

TRANSFERRING TO THE UNIVERSITY of CALIFORNIA (UC)

Regular Transfer (as a Junior)

If you wish to transfer as a junior to any of the campuses of the University of California, you should plan to complete 60 UC transferable units with at least a 2.4 minimum GPA at VVC, including those required in your major and those needed for completion of the general education requirements. You will also need to complete the seven course pattern for transfer admission eligibility.

For most students, this means you should follow the listings under the Intersegmental General Education Transfer Curriculum (IGETC), shown on the following pages.

There are some exceptions to the general recommendation to follow IGETC, most commonly for those students wishing to transfer to high-unit programs in engineering, performing arts, or in the sciences. For these majors, it is usually recommended that students focus on the major preparation pattern of the specific campus they plan to attend along with fulfilling some IGETC courses. Visit <http://www.assist.org> to find out what courses you need to take for your major.

UC Transfer Admissions Guarantee (TAG)

California Community Colleges have established a Transfer Admissions Guarantee (TAG) program with six UCs to encourage students to transfer to a UC and to facilitate that process. The TAG program has specific major, unit, GPA, and Math and English requirements to participate. Stop by the Transfer Center for more information.

The Intersegmental General Education Transfer Curriculum (IGETC)

IGETC (usually pronounced “eye-GET-see”) was developed in concert with the UC and CSU systems to create a set of general education courses that would be accepted in both systems (“segments,” hence “intersegmental”), so that students who have not made a final decision about where to transfer would be able to have one list of courses to follow, instead of two. Completing the IGETC, therefore, fulfills the lower division general education requirements for both the UC and the CSU systems without the need, after transfer, to complete any further lower division GE coursework.

It should be noted that completing the IGETC is neither a requirement for admission to UC or CSU, nor is it the only way to fulfill lower-division GE requirements.

Certification

When you have completed all the courses to be used for the IGETC, VVC can, at your request, certify to the UC or CSU campus you plan to attend that you have fulfilled all the lower division GE requirements. As a general rule, community colleges can certify the IGETC for transfer students who have also completed transfer units at a CSU, UC, or independent college, provided that the student has completed most of the transfer units at one or more California community colleges. Students who have been registered at a UC campus during a regular term (not summer or Extension) and wish to return to that campus are not eligible to use IGETC. Visit the Transfer Center or Counseling Department to request certification.

Limitations

All courses used for IGETC must be passed with a minimum grade of C (a C-minus is not acceptable). Credit or pass grades are acceptable, providing they are equivalent to the grade of C.

Restrictions

IGETC is not used for transfer to UC Berkeley’s Haas School of Business nor UC San Diego’s Revelle or Roosevelt Colleges. It is also not recommended for transfer into majors requiring extensive lower-division preparation, such as engineering, biology, chemistry, and others. Students in these programs should follow the general education pattern of the specific campus they plan to attend and fulfill as many major preparation courses as possible. Visit the Transfer Center or see a transfer counselor for thorough planning.

UC’s do not accept lower-division transfers at this time.

Planning to Transfer to UC or CSU?

visit www.assist.org

to find out what courses you need to complete for your major

Your official source for UC and CSU transfer information

Graduation and Transfer

IGETC

Victor Valley College

2017-2018

INTERSEGMENTAL GENERAL EDUCATION (GE) TRANSFER CURRICULUM (IGETC)

For information on courses for your transfer major, visit www.assist.org.
If you are pursuing an AA-T or AS-T, visit www.adegreewithaguarantee.com and meet with a VVC counselor.

OBJECTIVE: Completion of all the requirements in the Intersegmental General Education Transfer Curriculum (IGETC) permits a student to transfer from a community college to a campus in either the California State University or the University of California system without the need, after transfer, to take additional lower-division general education courses to satisfy the university's general education requirements.

EXCEPTIONS: All campuses will accept IGETC except UC Berkeley's Haas School of Business and UC San Diego's Roosevelt and Revelle Colleges. Also, IGETC is not recommended for science, engineering, or other high unit majors at most campuses. These students should follow the general education pattern of the specific campus they plan to attend. Visit assist.org for more information.

CERTIFICATION: All areas of the IGETC should be certified prior to transfer. Partial certification may be awarded if all but two (2) courses in any area except Group 1 and 2 are completed. Students are responsible for requesting IGETC certification by completing the "CSU and UC General Education Certification" form available in Counseling.

Each course must be completed with a grade of "C" or better.

Legend: C = Units Completed IP = Units In Progress N = Units Needed H = Honors Course L = Lab

AREA 1 - ENGLISH COMMUNICATION CSU: Three courses required, one from Group 1A, one from Group 1B, and one from Group 1C. UC: Two courses required, one from Group 1A and one from Group 1B.	C	IP	N
Group 1A: ENGLISH COMPOSITION (Choose one course, 3 semester units minimum.) ENGL 101/H101 Course from Other College: _____ Advanced Placement _____ <div style="text-align: right; font-size: small;">Test Name and Score</div>			
Group 1B: CRITICAL THINKING AND ENGLISH COMPOSITION (Choose one course, 3 semester units minimum.) ENGL 104/104H; PHIL 207*; RLST 207* Course from Other College: _____			
Group 1C: ORAL COMMUNICATION - CSU requirement only (Choose one course, 3 semester units minimum.) CMST 106, 108, 109 Course from Other College: _____			
AREA 2 - MATHEMATICAL CONCEPTS AND QUANTITATIVE REASONING Choose one course, 3 semester units minimum.			
MATH 105/105H, 116, 120/120H, 132, 226/226H, 227/227H, 228/228H, 231, 270; PSYC 215 Course from Other College: _____ Advanced Placement _____ <div style="text-align: right; font-size: small;">Test Name and Score</div>			
AREA 3 - ARTS AND HUMANITIES Three courses required, with at least one from Group 3A and one from Group 3B, 9 semester units minimum.			
Group 3A: ARTS ART 101, 102, 104, 105, 106, 107, 108, 109; ENGL 116*; KIN 103 (History of Dance), MUSC 100, 101, 102, 103, 116, 117, 118, 202, 204; TA 101, 102, 116* Course from Other College: _____ Advanced Placement _____ <div style="text-align: right; font-size: small;">Test Name and Score</div>			
Group 3B: HUMANITIES ANTH 106; ASL 124, 125; CMST 105 (Intercultural); ENGL 102/102H, 220, 225, 230, 231, 232, 233, 234, 240, 241, 245, 246, 247; FREN 103, 104; HIST 103, 104, 117/117H, 118/118H, 130, 131, 155, 157; PHIL 101, 108, 114*, 117*, 120, 121; POLS 114*; RLST 101, 105, 106, 110, 111, 115, 117*; SPAN 103, 104 Course from Other College: _____ Advanced Placement _____ <div style="text-align: right; font-size: small;">Test Name and Score</div> <p style="font-size: small;">ASL, FREN, and SPAN courses in Area 3B may be used to clear the LOTE Area (see over) without need to take another course.</p>			
Group 3: One additional course from any of the above courses listed under 3A or 3B Course from Other College: _____ Advanced Placement _____ <div style="text-align: right; font-size: small;">Test Name and Score</div>			

*Cross-listed courses are the same course listed under different departments:
 ENGL 116 = TA 116; PHIL 114 = POLS 114; PHIL 117 = RLST 117; PHIL 207 = RLST 207

Graduation and Transfer

Legend: C = Units Completed IP = Units In Progress N = Units Needed H = Honors Course L = Lab

AREA 4 - SOCIAL AND BEHAVIORAL SCIENCES	C	IP	N
Choose three courses from at least two different disciplines, 9 semester units minimum.			
<p>AGNR 175; ANTH 101, 102, 103, 105, 106; CHDV 106; CMST 105 (Intercultural); ECON 101, 102; GEOG 102, 104; HIST 103, 104, 115, 117/117H, 118/118H, 130, 131, 155, 157; PHIL 114*; POLS 101, 102/102H, 110, 112, 113, 114*, 206, 211; PSYC 101, 110, 111, 121, 204, 213; RLST 113, 115; SOC 101, 102, 107. NOTE: No credit for PSYC 110 if taken after PSYC 111.</p> <p>Course from Other College: _____ Advanced Placement _____ <small>Test Name and Score</small></p>			

AREA 5 - PHYSICAL AND BIOLOGICAL SCIENCES	C	IP	N
One course from Group 5A and one from Group 5B, 7 semester units minimum. At least one course must include a laboratory, indicated by (L).			
<p>Group 5A: PHYSICAL SCIENCES</p> <p>AGNR 170; ASTR 101; CHEM 100(L), 201(L), 202(L), 206/H206(L), 207(L), 281(L), 282(L); GEOG 101, 101L(L); GEOL 101(L); OCEA 101; PSCI 101; PHYS 100(L), 201(L), 202(L), 203(L), 204(L), 221(L), 222(L)</p> <p>Course from Other College: _____ Advanced Placement _____ <small>Test Name and Score</small></p> <p>NOTE: No credit for CHEM 100 if taken after CHEM 201. No credit for PSCI 101 if taken after a college course in astronomy, chemistry, geology, meteorology, oceanography or physics. No credit for PHYS 100 if taken after PHYS 201 or 221. PHYS 221, 222 (General series) and 201, 202, 203, 204 (Engineering series) combined: maximum credit, one series.</p>			
<p>Group 5B: BIOLOGICAL SCIENCES</p> <p>ANTH 101, 101L(L); BIOL 100(L), 118, 201(L), 202(L), 211(L), 221(L), 231(L);</p> <p>Course From Other College: _____ Advanced Placement _____ <small>Test Name and Score</small></p>			
<p>Group 5C: LABORATORY ACTIVITY</p> <p>Any science course in Area 5A or 5B which includes a lab (L) fulfills this requirement. Check appropriate box.</p>			

LANGUAGE OTHER THAN ENGLISH (LOTE) - UC Requirement for IGETC Certification	C	IP	N
May be fulfilled in one of the following ways:			
<p>____ Complete 2 years of the same foreign language in high school with a grade of "C" or better. Submit official high school transcript to VVC Admissions and Records Office.</p> <p>OR</p> <p>____ Complete one of the following Victor Valley College foreign language courses or equivalent course at another college: ASL 122, 123, 124, 125; FREN 101, 102, 103, 104; SPAN 101, 101AB, 102, 103, 104</p> <p>OR</p> <p>____ Complete two years of formal schooling at the 6th grade level or above at an institution where English is not the language of instruction. Submit official translation of transcript to VVC Admissions and Records Office.</p> <p>OR</p> <p>____ Score of 3 or higher on Foreign Language Advanced Placement test, or a score of 550 or higher on the College Board Achievement Test in Foreign Language. Submit official transcript to VVC Admissions and Records Office.</p>			

U.S. HISTORY, CONSTITUTION AND AMERICAN IDEALS	C	IP	N
<p>CSU Graduation Requirement Only</p> <p>Not part of certification of IGETC, but highly recommended to be completed prior to transfer. One course from Group 1 and one course from Group 2; 6 semester units minimum.</p>			
<p><input type="checkbox"/> Group 1: POLS 102/102H <input type="checkbox"/> Group 2: HIST 117/117H or HIST 118/118H or HIST 155</p> <p>NOTE: At the discretion of each CSU campus, courses used to meet this requirement may simultaneously count toward fulfilling requirements in Areas 3 or 4 of IGETC.</p>			

Except as noted, a course may not be used to fulfill more than one requirement even though it may be listed in more than one area.

Note: Underlined courses satisfy VVC's Global Citizenship requirement (not necessary for transfer to UC or CSU).

CERTIFICATION: For full or partial IGETC certification, complete the **CSU and UC General Education Certification** form available in Counseling or in the Transfer Center.

THE 23 OUTSTANDING CAMPUSES OF THE CSU



Graduation and Transfer

TRANSFERRING TO CALIFORNIA STATE UNIVERSITY (CSU)

Regular Transfer (as a Junior)

Students who have completed at least 60 CSU transferable units with a grade point average of 2.0 or higher are eligible to apply for transfer to the CSU system. Students must also complete the Golden Four as part of the minimum admission criteria. Most CSU's require you to be an upper-division transfer student.

General Education/Breadth Certification

Students planning to graduate from any of the 23 campuses of CSU should complete the CSU GE Breadth Requirements prior to transfer, if possible. This list, found on the following pages, covers five general subject areas, A-E. On completion, and at the student's request, VVC can certify to the transfer campus that the student has fulfilled all lower-division GE requirements. It is to your advantage to complete the entire pattern before transfer. However, VVC can provide partial certifications, leaving you to fulfill uncompleted areas at the transfer campus according to their requirements, which may differ considerably. In addition, it is highly encouraged to complete as many major preparatory courses as possible. Visit the Counseling Department or Transfer Center to request certification.

Intersegmental General Education Transfer Curriculum (IGETC)

For students who have not yet decided whether to transfer to a CSU or to a UC campus, an alternative to the CSU's GE Breadth pattern for satisfying general education requirements is the IGETC, which will satisfy both CSU and UC general education requirements.

Guaranteed Transfer To Cal State San Bernardino (CSUSB)

Many students elect to transfer to California State University at San Bernardino, which offers a special "guaranteed admission" contract to our students. This agreement guarantees that, on completion of 60 transferable units at VVC, and having a 2.0 minimum GPA the student will be admitted to CSUSB with full junior status. To develop such a contract, visit the Transfer Center to make an appointment with the CSUSB representative, who comes to VVC on a regular basis.

Transferring with Fewer Than 60 Units

Although very few CSU's accept lower-division transfer students, if you wish to transfer to the CSU system with fewer than 60 transferable units, you will need to do the following:

Take the ACT or SAT

You will need to take either the ACT or the SAT to determine whether you will be admitted as a freshman or as a sophomore. These tests are given several times per year; schedules and application forms are available in the Transfer Center.

Clear any missing college preparatory requirements

If you did not complete the appropriate subject requirements in high school, you can take equivalent courses at VVC (or in adult school or in high school summer sessions; minimum grade of C required) to clear any deficiencies, or earn acceptable scores on specified examinations. Visit the Transfer Center or see a counselor for more information.

Check the website of the CSU campus you are interested in to find out if they accept lower-division transfer students.



**Associate Degree
for Transfer**
A Degree with a Guarantee.SM

Visit www.adegreewithaguarantee.org for more info about earning an associate's degree with guaranteed admission to the California State University system.

**FOR CSU
ADMISSIONS INFORMATION
AND APPLICATIONS,
visit
WWW.CSUMENTOR.EDU**

**CONSIDERING TRANSFERRING
TO A PRIVATE UNIVERSITY?
visit
WWW.AICCU.EDU**

Your source for information on transferring to independent (non-UC or -CSU) colleges

Graduation and Transfer

CSU

Victor Valley College

2017-2018

California State University (CSU)

General Education (GE) Requirements for Transfer Certification

Student's Name _____ Last four digits of SS# _____ Birthdate ____/____/____
Last First Middle Month Day Year

VVC ID# _____

For information on courses for your transfer major, visit www.assist.org.

If you are pursuing an AA-T or AS-T, visit www.adegreewithaguarantee.com and meet with a VVC counselor.

Focus first on completing the "Golden Four" GE Areas: A1, A2, A3, and B4.

Certification:

1. If possible, complete the following lower-division general education requirements in Areas A-E before transferring to any of the 23 campuses of the CSU system.
2. VVC awards a student full or partial certification by subject area for completion of the following lower-division general education transfer requirements.
3. In accordance with Executive Order 595, students admitted to any CSU with full or partial certification will not be held to any additional lower-division general education requirements in the areas certified. Students may be held to other lower division graduation requirements.
4. Full Certification - All areas completed with a minimum of 39 units.
5. Partial GE Certification before transfer can be provided in any Area. Full Certification after transfer is subject to the particular rules of the receiving university.
6. If not fully certified before transfer, students may be required to complete the general education pattern of the specific campus to which they transfer.
7. Students must request certification by completing the "CSU and UC General Education Certification" form available in Counseling or in the Transfer Center.

Important Points:

1. A minimum of 9 additional semester units of upper-division general education must be completed at the CSU campus.
2. If a student completes a course in a year it did not appear on the CSU General Education course list, it cannot be used for GE certification.
3. A minimum of 60 units of transferable courses must be completed to transfer as a junior.
4. Credit is awarded for either an honors or non-honors course, not both. For example, students may receive credit for Math 105 or Math 105H, not both.
5. A single course may not fulfill more than one general education requirement even though it may be listed in more than one area.

DIRECTIONS: Circle courses and tally units in appropriate columns.

Legend: C = Units Completed IP = Units In Progress N = Units Needed H = Honors L = Lab

	C	IP	N
AREA A. COMMUNICATION IN THE ENGLISH LANGUAGE AND CRITICAL THINKING.....minimum 9 units <i>Choose one course from each of the three areas below. Each course from Area A must be completed with a "C" grade or better.</i>			
A1 ORAL COMMUNICATION CMST 106, 107, 108, 109 Course from other college:			
A2 WRITTEN COMMUNICATION ENGL 101/H101 Course from other college:			
A3 CRITICAL THINKING ENGL 104/104H, PHIL 109, 207*, RLST 207* Course from other college:			
AREA B. SCIENTIFIC INQUIRY AND QUANTITATIVE REASONING.....minimum 9 units <i>Choose at least one course from B1 Physical Sciences, one course from B2 Life Sciences, and one course from B4 Mathematics. At least one science course must include a laboratory to fulfill B3.</i>			
B1 PHYSICAL SCIENCE <u>Courses which include a LABORATORY:</u> CHEM 100, 201, 202, 206, 207, 281, 282 GEOG 101 + 101L, 130 GEOL 101 PHYS 100, 201, 202, 203, 204, 221, 222 <u>Courses which do NOT include a laboratory:</u> AGNR 170; ASTR 101; GEOG 101 OCEA 101; PSCI 101 Course from other college:			
B2 LIFE SCIENCE <u>Courses which include a LABORATORY:</u> ANTH 101 + 101L BIOL 100, 107, 201, 202, 203, 210, 211, 221, 231 <u>Courses which do NOT include a laboratory:</u> AGNR 123; ANTH 101 BIOL 118; PSYC 109 Course from other college:			
B3 LABORATORY ACTIVITY <i>Any science course in Area B1 or B2 which includes a lab fulfills this requirement.</i>			
B4 MATHEMATICS <i>The course used to fulfill B4 must be completed with a "C" grade or better.</i> MATH 104, 105/105H, 116, 120/120H, 132, 226/226H, 227/227H, 228/228H, 231, 270; PSYC 215 Course from other college:			

Graduation and Transfer

Legend: C = Units Completed IP = Units In Progress N = Units Needed H = Honors L = Lab

AREA C. ARTS AND HUMANITIES.....minimum 9 units <i>Choose at least one course from the ARTS and one course from the HUMANITIES.</i>	C	IP	N
C1 ARTS ART 101, 102, 104, 105, 106, 107, 108, 109, 112, 113, 114, 120, 122, 125, 150; CART 133; ENGL 116*; KIN 103 (History of Dance); MUSC 100, 101, 102, 103, 116, 117, 118, 131, 202, 204; TA 101, 102, 107, 110, 116* Course from other college:			
C2 HUMANITIES ANTH 106; CMST 105 (Intercultural Communication); ENGL 102/102H, 109, 116*, 220, 225, 230, 231, 232, 233, 234, 235, 240, 241, 245, 246, 247; HIST 103, 104, 115, 117/117H, 118/118H, 130, 131, 155, 157; PHIL 101, 108, 114*, 117*, 120, 121; POLS 114*; RLST 101, 105, 106, 110, 111, 115, 117*; TA 104, 116* ASL 122, 123, 124, 125; FREN 101, 102, 103, 104; SPAN 101, 101A, 101B, 102, 103, 104 Course from other college:			
C ONE ADDITIONAL COURSE FROM ANY OF THE ABOVE COURSES LISTED UNDER C1 OR C2 Course used from above: Course from other college:			
AREA D. SOCIAL SCIENCES.....minimum 9 units <i>Choose courses from at least TWO different subject areas in AREA D.</i>			
UNITED STATES HISTORY REQUIREMENT FOR CSU GRADUATION HIST 117/117H or 118/118H or 155 Course from other college:			
UNITED STATES CONSTITUTION AND AMERICAN IDEALS REQUIREMENT FOR CSU GRADUATION POLS 102/102H Course from other college:			
ONE ADDITIONAL COURSE FROM AREA D <i>Choose one additional course not used above from the following:</i> AGNR 175, 178; AJ 101; ANTH 101, 102, 103, 105, 106; CHDV 100, 106; CMST 105 (Intercultural Communication); ECON 101, 102; ENGL 234; GEOG 101, 102, 103, 104; HIST 103, 104, 115, 117/117H, 118/118H, 130, 131, 155, 157; PHIL 114*; POLS 101, 102/102H, 103, 104, 110, 112, 113, 114*, 206, 211; PSYC 101, 110, 111, 121, 204, 213; RLST 113, 115; SOC 101, 102, 103, 107 Course(s) from other college:			
<i>NOTE: Students may use any 9 units from this section to fulfill certification requirements for Area D, but they are encouraged to complete the above U.S. History, Constitution and American Ideals requirements as part of Area D. All CSU campuses, except Chico State, permit these courses to also satisfy Area D requirement.</i>			
AREA E. LIFELONG LEARNING AND SELF-DEVELOPMENT.....minimum 3 units			
ALDH 125; CHDV 100; GUID 101, 105, 107; HLTH 102; PSYC 101, 110, 121, 125, 133; SOC 103; KIN 104 OR KIN 150 (taken as a 2-unit course) AND 1 unit from APE 160; KIN 160, 161, 162, 163, 164, 181, 185C, or 186B Course(s) from other college:			
*Cross-listed courses are the same course listed under different departments: ENGL 116 = TA 116; PHIL 114 = POLS 114; PHIL 117 = RLST 117; PHIL 207 = RLST 207			
TOTAL			

Note: Underlined courses satisfy VVC's Global Citizenship requirement (not necessary for transfer to CSU).

CERTIFICATION

The student has fulfilled the following California State University requirements in U.S. History, Constitution and American Ideals:

U.S. HISTORY

HIST 117/117H or HIST 118/118H or HIST 155
 Course from other college: _____

U.S. CONSTITUTION AND AMERICAN IDEALS

POLS 102/102H
 Course from other college: _____

The student has fulfilled the following lower division requirements for general education certification:

FULL CERTIFICATION OR PARTIAL CERTIFICATION: Subject Areas Certified A B C D E

College Evaluator _____ Title _____ Date _____

Graduation and Transfer

GENERAL INFORMATION ABOUT TRANSFERRING

Transferring to Independent or Out-of-State Colleges

In addition to state-funded institutions, California boasts many accredited independent colleges and universities. Other states similarly have a huge variety of schools from which to choose. Generally, in-state public school tuition costs are the lowest, but financial aid packages can sometimes absorb much of the difference. For information about private and out-of-state institutions, whose requirements vary considerably, contact the Transfer Center.

Some of these institutions that students commonly transfer to include:

Argosy University	Concordia University	Southern Illinois University
Arizona State University	Embrey-Riddle Aeronautical University	University of Arizona
Azusa Pacific University	La Sierra University	University of La Verne
Baptist University	Loma Linda University	University of Nevada
Bellevue University	Loyola Marymount University	University of Phoenix
Biola University	Masters College	University of Redlands
Brandman University California	NewSchool of Architecture & Design	University of Southern California
Cambridge College	Occidental College Park University	Western Governors University
Chapman University	San Joaquin Valley College	

Note that some of these schools may accept CSU-GE or IGETC. Please visit: <https://secure.californiacolleges.edu/college-planning/california-independent-colleges/AdmissionRequirements/TransferAdmission.aspx>.

Transfer Center

It's a good idea to begin thinking about your transfer goals fairly early in your studies, so that you can be taking a well-planned program of courses towards your objectives. The Transfer Center, located in Building 55, is the place to go to find out about majors, universities and colleges. Please visit our website: <http://www.vvc.edu/offices/transfer-center>. In the Transfer Center you'll find catalogs from colleges and universities all over California and from some out-of-state institutions which, like this catalog in your hands, show programs of study, course descriptions, photographs of the campus, requirements for degrees, and much more. For institutions where we don't have an actual catalog, we can help you find information Online. Other continuously updated programs offer you similar opportunities to research your options.

College Representatives

Representatives from public and private four-year institutions are available to meet with prospective students at the Transfer Center. Representatives are available to discuss majors, admission requirements, applications, etc. Please contact the Transfer Center to schedule an appointment.

Annual College Fair

The Transfer Center hosts a College Fair each Fall semester where representatives from both in- and out-of-state colleges and universities visit the campus to provide information about their institutions and programs.

Campus Visits

In addition to reviewing catalogs and other written materials on the campuses you are considering, it is a good idea to personally visit those institutions. The Transfer Center organizes group campus tours in both the Fall and Spring semesters.

Check out not only the campus itself, but also the surrounding areas. Do you want to be in an urban setting? Rural? Desert? Coastal? What is the "flavor" of the place and would you feel comfortable there? Visit the libraries, shopping areas, recreation facilities, cafes, bookstores, movie houses and other components that make up a student's life. To explore living situations, visit the university's housing office; also, look at the want ads in the local newspaper.

Counseling Resources

Counselors are available to all students for help in identifying personal and educational goals, selecting a major, planning courses to meet their objectives, and in dealing confidentially with personal situations that affect their education. We strongly recommend that all students planning to transfer meet with a VVC counselor to ensure that their courses are in line with their goals and requirements.

Graduation and Transfer

Career planning classes (look in the Class Schedule under “Guidance”), an annual career options conference, career testing, and other resources are available in the Career Center to help students explore their alternatives.

Transcripts of Records

Every course you take, and every grade you receive, is documented on your college transcript.

Unofficial

Unofficial transcripts are for your personal use, or for initial planning purposes with counselors or advisors at other institutions. Current students can access and print their unofficial transcripts by logging into WebAdvisor

Official

Colleges or universities you transfer to, and some employers, require official transcripts to assess your academic history at VVC and grant credit for your experiences here. For the most up-to-date information about ordering official transcripts, please visit <http://www.edu/transcripts/>

- **Ordering Official Transcripts Online** You can securely order your transcripts online, which will be sent directly to you or to another institution. Depending on whether you choose regular, rush, or Fedex service, prices range from \$5 to \$23 with delivery between 1 and 5 business days later.
- **Mailed and In-person requests** - These orders take 2 - 3 weeks to process.

Applying for Admission

The University of California (UC system) and the California State University (CSU system) are different and distinct branches of public higher education in California and have different requirements for admission. To apply to the University of California or the California State University systems, students should plan to complete an Online application within the filing period. The Transfer Center will provide assistance with applications. Students will also be required to submit official transcripts and possibly additional documentation when requested. Contact other institutions directly for information about applications.

Application Deadlines

To better their chances for acceptance, students should apply to every university for which they want to be considered during the initial or priority application filing period. Students planning to apply to a private university need to research what the initial or priority application filing period is for each specific private university. Certain impacted or highly competitive majors may require earlier deadlines. It is the student’s responsibility to research what these deadlines are.

Each individual campus closes application filing periods at different times according to how many students apply. A student who is filing an application late should contact the Admissions Department of the specific college for which he is applying to inquire if applications are still being accepted.

Application deadlines vary by campus. For information on the University of California (UC) system, visit www.universityofcalifornia.edu/admissions. For information on the California State University (CSU) system, go to www.calstate.edu. Note that deadlines are usually quite far in advance; for example, applications may be due as early as October of one year for admission to the Fall term of the following year.

Impacted Majors

At some UC and CSU campuses, more students may seek admission to popular areas of study such as engineering, computer science, and business than can be accommodated. Occasionally, more applications are received than can possibly be accepted at the particular school. When this happens at a UC or CSU campus, certain majors are declared “impacted,” and these schools may permit only limited enrollment. Students who apply to impacted majors may also be directed to alternate campuses. Applicants to impacted majors are subject to supplementary admission criteria and an additional application.

Students who seek to transfer into majors which are impacted should complete all courses designated as “required lower division preparation” for the major, prior to transfer.

At some schools, completion of specific courses with minimum grades is required before transfer as a condition of acceptance into an impacted major.

Graduation and Transfer

Maximum Transferable Credit

A maximum of 70 semester or 105 quarter units earned in California community colleges may be applied toward the baccalaureate degree at either a UC or CSU campus. The maximum number of units accepted at in-state private universities and out-of-state universities may vary.

Notice of Responsibility: Students should always study the catalog and website of the school to which they plan to transfer, and are responsible for directly contacting that institution's admissions office for the most current, up-to-date information. No matter how much help you may receive from various sources, it is ultimately your responsibility to ensure that all transfer requirements and deadlines are met.

For more information about transferring, visit these websites:

CaliforniaColleges.edu covers UC, CSU and independent colleges, and provides virtual campus tours, student-campus matching assistance, information on financial aid, and admissions planners for first-year and transfer students.
www.californiacolleges.edu/

The University of California, Office of the President, offers this site for information about UC. It also provides links to each of the ten UC campuses.
www.universityofcalifornia.edu (UC)

This site provides information about California State University's educational programs, system wide policies and initiatives, historical and general information, admission requirements and procedures and access to links for all 23 CSU campuses. It also provides outreach, financial aid, and admission information about the CSU system. Here, you can take virtual campus tours, develop a comparative view of different campuses, establish e-mail connections with campus personnel, and apply electronically.
www.calstate.edu (CSU)

The ASSIST website is the most up-to-date source for community college course transferability to UC and CSU campuses. It also provides lists of courses required for various majors and shows which courses are accepted for transfer general education. We have formal, course-to-course equivalency agreements between VVC and many of the UC and CSU campuses
www.assist.org

This is the official web site of the Association of Independent California Colleges and Universities. Visit this site for information on independent (non-UC or CSU) schools in California
www.aiccu.edu.

(ADT) is an exciting new development. Earning an AA-T or an AS-T degree makes it easy to transfer from a California community college into the CSU system. Check out your degree options and choice of university campuses to find one that's right for you.
www.adgreewithaguarantee.com

Career Exploration Websites

To really explore who you are – your skills, your likes, your dislikes, and how those may influence your career – it can be a long but fun process. We suggest you start with:

EUREKA Online - Our Site: **Victor Valley College** | Site ID Code: **JZVLEQG**

To create your personal EUREKA Online Account:

1. Go to www.eureka.org and click on Sign Up.
2. Under Students/Clients, enter site ID Code (see above), then click Next.
3. Complete the personal information form, click Next.
4. Choose a Log in name and password. Do not use spaces or special characters. If your desired login name or password is already taken, you will be directed to try again.

Here are some other Online sources for exploring careers, resume writing, interviewing, etc.:

- **Who Do You Want to Be** <http://whodouwant2b.com/>
- **Health Careers** www.explorehealthcareers.org
- **California Career Zone** <http://www.cacareerzone.org/>
- **Occupational Outlook Handbook** (U.S. Bureau of Labor Statistics) <http://www.bls.gov/oco/>
- **O*NET Resource Center** <http://www.onetcenter.org/>
- **America's Career Info Net** (Career One Stop) www.careeronestop.org/toolkit/ACINet.aspx
- **Chronicle Guidance Publications** www.chroniclecareerlibrary.com

Username: **vvc** Password: **rams**

What can I do with a career in ...?" <http://career.berkeley.edu/Survey/survey> from UC Berkeley's career website

- UC Riverside's selection of virtual career services
<http://careers.ucr.edu/onlineservices/onlineworkshopsresources/multimedia.html>

Graduation and Transfer

COLLEGE ACCREDITATION

NOT ALL ACCREDITATION IS THE SAME!

College and university representatives can be very aggressive in trying to recruit you; be prepared and be careful! If you have questions about a school, your VVC counselor will be happy to discuss it with you.

What is accreditation?

Accreditation is one of the most important factors to consider when selecting an academic program. It means that a program or institution has gone through a rigorous review and evaluation process by experts in the field. It is essentially a stamp of approval by an organization that evaluates the quality of an institution or program. The highest level of accreditation is regional accreditation.

Will my courses transfer to another institution?

If you think you may want to transfer to another school in the future, move to another state, or obtain an associate or baccalaureate degree, then enrolling in some schools could present barriers for you later. (Each school has different requirements for transfer credits; contact the institution you wish to transfer to).

How important is accreditation to employers?

Employers want well-qualified employees, and usually are unimpressed by degrees from non-accredited schools or from schools that are accredited by nonrecognized agencies. Many federal or state agencies require graduation from a regionally accredited school. In certain professions, internship and practicum opportunities are limited to students who attend an accredited program.

What are some potential consequences of attending a school with questionable accreditation?

- **You may not find a job in your profession**

Depending on the profession and the state you live in, you may have difficulty finding a job. Some employers will not hire you unless you attended an accredited institution. If you are enrolled in a nonaccredited school, talk to students who graduated recently and ask if they were able to find a job.

- **You may not be able to attend a four-year or graduate school**

It is in your best interest to attend an accredited institution if you plan to further your education. Your acceptance to a four-year or graduate school could be denied because the institution may not recognize courses taken at a non-accredited institution (or one accredited by a non-recognized agency).

- **You may be wasting your time and money**

If you graduate from a non-accredited school and find out you cannot obtain employment, you will have lost valuable time and money.

- **You may face challenges repaying student loans**

Two thirds of students borrow to pay for college. If you are one of these students, you may have challenges repaying your student loans if you don't earn enough money or cannot find suitable employment.

Recognized Accrediting Organizations

There are national accreditors, faith-based accreditors, career college accreditors, and regional accreditors. Victor Valley College and other traditional public and private colleges and universities can only accept coursework from regionally-accredited institutions. Units can be accepted from colleges accredited by any of the following organizations. (VVC, like UC and CSU, is accredited by WASC.)

Regional Institutional Accrediting Organizations

MSA - Middle States Association of Colleges and Schools

NWCC - Northwest Commission on Colleges and Universities

NCA - North Central Association of Colleges and Schools

NEASC - New England Association of Schools and Colleges

SACS - Southern Association of Colleges and Schools

WASC - Western Association of Schools and Colleges

Here are some examples of accrediting agencies that VVC, UC, and CSU cannot accept:

ABHE - Association for Biblical Higher Education

ACCSC - Accrediting Commission for Career Schools and Colleges

ACICS - Accrediting Council for Independent Colleges and Universities

DETC - Distance Education and Training Council Accrediting Commission

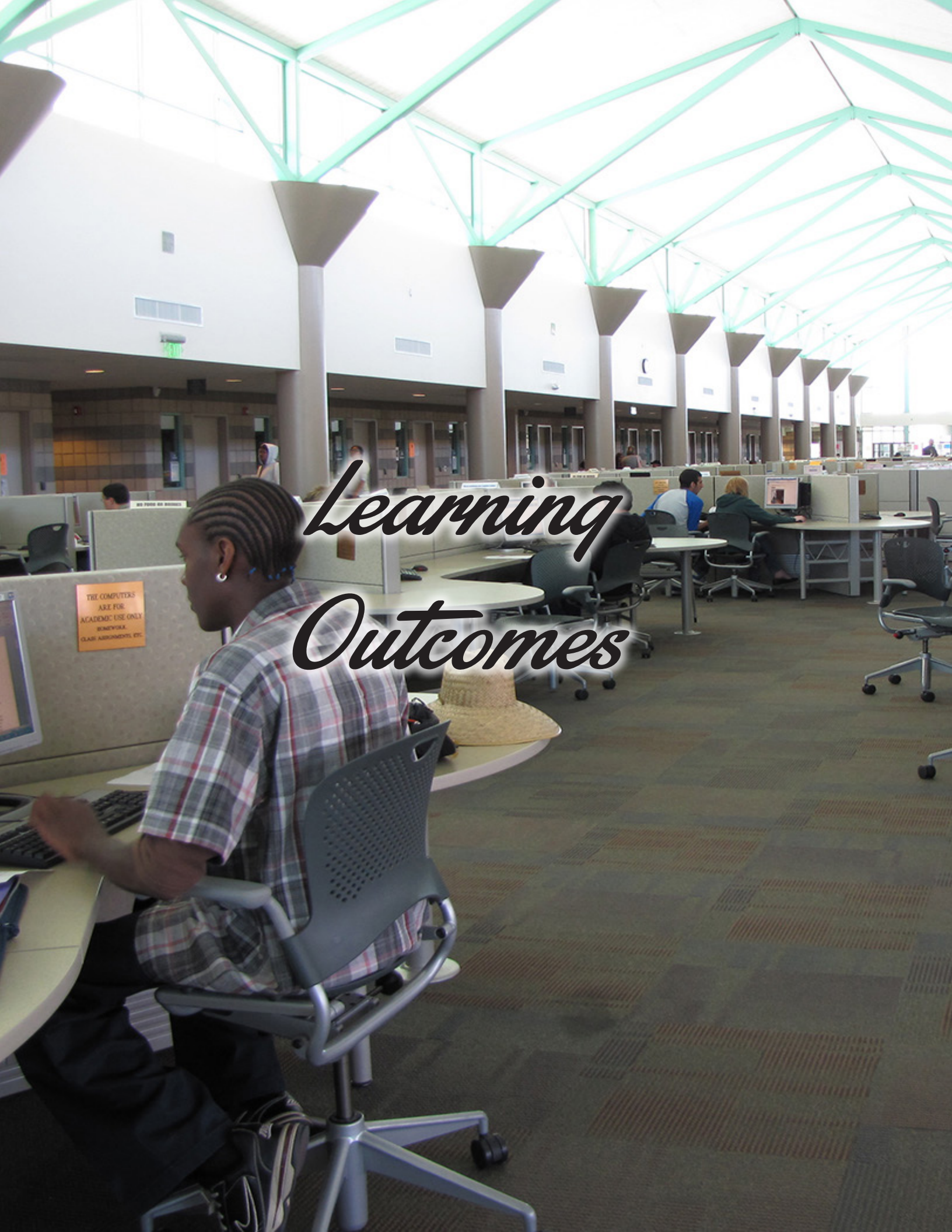

*Learning
Outcomes*

Learning Outcomes

Learning Outcomes

Learning Outcomes is the broad term to describe the campus endeavor towards improving student learning. Learning Outcomes tell students what they will know or be able to do at each stage of their studies (e.g. courses, programs, co-curricular experiences). The Student Learning Outcomes and Assessment Committee guides the campus through learning outcomes assessments and establishes practices to ensure smooth processes.

Institutional Learning Outcomes (ILOs)

Victor Valley College has adopted the following institutional outcomes to define the learning that all students are intended to achieve as a result of their experience with the college's instructional, student support, and campus support programs.

Communication:

Read and write analytically including evaluation, synthesis, and research; deliver focused and coherent presentations.

Computation:

Apply complex problem-solving skills using technology, computer proficiency, decision analysis (synthesis and evaluation), applications of mathematical concepts and reasoning, and the analysis and use of numerical data.

Creative, Critical and Analytical Thinking:

Apply procedures for sound reasoning in the exercise of judgment and decision making; demonstrate intellectual curiosity and a respect for learning; solve problems through analysis, synthesis, evaluation and creativity; identify, evaluate and appropriate use of multiple sources of information.

Social and Personal Responsibility:

Evaluate the relationship between natural, social and economic systems and the significance of sustainability; demonstrate responsible attitudes toward cultural diversity, citizenship, personal contribution to local and international communities, and the effect of human actions on the environment.

Information Competency:

Students demonstrate information competency and critical thinking skills through their ability to effectively locate, retrieve, evaluate and utilize use library and information resources within the guidelines of academic standards to meet collegiate and personal information needs.

Program Learning Outcomes (PLOs)

A Program of Study identifies the pathway a student might take to complete a certificate of completion, certificate of achievement, an associate degree, or transfer to a four-year college or university. Each Program of Study defines the Program Learning Outcomes (PLOs) to be achieved. Victor Valley College offers several Programs of Study listed in the Instructional Programs section of this catalog. The Program Learning Outcomes for each Program of Study are listed in the respective departmental areas. PLOs can also be found at this link <http://www.vvc.edu/offices/cfie/plos.shtml>.

Student Learning Outcomes (SLOs)

Each course a student takes at VVC will have defined outcomes called Student Learning Outcomes. These describe the knowledge, skills, or abilities that student should expect to gain by the end of the course. Student Learning Outcomes are listed on the syllabus for each course. SLOs can also be found at this link <http://www.vvc.edu/offices/cfie/slos.shtml>.

Courses meeting the VVC general education requirements will also be linked to Institutional Learning Outcomes. The General Education pattern at Victor Valley College is a comprehensive and integrated introduction to broadly applicable principles, concepts, and methods of the natural sciences, social sciences, humanities, communication, and mathematics. The awarding of an associate degree by VVC is intended to represent more than an accumulation of units. It is to symbolize a successful attempt on the part of the student to complete a series of learning experiences designed to increase knowledge, develop competencies, enhance insights, and encourage lifelong learning.



Instructional Programs

Degrees and Certificates

The college offers the Associate of Science Degrees (A.S.), Associate of Arts Degrees (A.A.) and Associate Degrees for Transfer (AA-T, AS-T), and two kinds of certificates:

Certificates of Achievement (CA) are awarded for completion of programs that consist of 18 or more units, and are approved by the California Community Colleges Chancellor's Office. CAs are noted on students' official college transcripts.

Certificates of Career Preparation (CP) recognize completion of a sequence of fewer than 18 units, approved by the VVC Board of Trustees. Students are presented a paper award, but the certificate does not appear on the college transcript.

Administration of Justice, A.S., AS-T

Administration of Justice Certificate (CA)
Corrections Officer Core Course Certificate (CP)
Forensic Specialist Certificate (CP)
Law Enforcement Modulated Course Level III Certificate (CP)
PC 832 Law Enforcement Course Certificate (CP)

Campus Law Enforcement Course PC 832.3 Certificate (CP)
Fingerprint Recognition and Classification Certificate (CP)
Law Enforcement Modulated Course Level II Certificate (CP)
PC 832 Firearms Only Certificate (CP)
Police Technician Specialist Certificate (CP)

Environmental Horticulture, A.S.

Agriculture and Natural Resources Career Exploration (CP)
Animal Health Technician Certificate (CP)
Animal Science Specialist Certificate (CP) Environmental Horticulture and Restoration Technician Certificate (CP)
Equine Science Specialist Certificate (CP)
Geospatial Technician Certificate (CP)

Horticulture Specialist Certificate (CA)
Landscape Specialist Certificate (CA)
Water Resource Management Certificate (CP)
Floral Design Technician Certificate (CP)
Irrigation Design Technician Certificate (CP)
Natural Resource Management Technician Certificate (CP)
Plant Science Technician (CP)

Allied Health*

Nursing Assistant/Home Health Aide Certificate (CP)

Automotive Technology, A.S.

Automotive Detailer/Porter Certificate (CP)
Automotive Inspection and Maintenance Technician Cert. (CP)
Automotive Specialist I Certificate (CA)
Automotive Technician Certificate (CA)
Smog Inspection Technician Certificate (CP)

Automotive Brake & Suspension Specialist Certificate (CP)
Automotive Drivability Specialist Certificate (CP)
Automotive Repair Shop Manager Certificate (CP)
Automotive Specialist II Certificate (CA)
Automotive Transmission Specialist Certificate (CP)
Small Engine Repair Specialist Certificate (CP)

Aviation Maintenance Technology,, A.S.

Aviation Airframe Technician Certificate (CA)

Aviation Power Plant Technician Certificate (CA)

Business, A.S.

Business Administration, A.S.

Bookkeeping I Certificate (CP)

Management Certificate (CA)

Business Education Technologies, A.S.

Administrative Assistant Certificate (CA)
Computer Systems II Certificate (CA)
Legal Office Certificate (CA)
Office Services Certificate (CP)
Word Processor Certificate (CP)

Computer Systems I Certificate (CP)
Data Typist Certificate (CP)
Medical Office Certificate (CA)
Spreadsheet Processor Certificate (CP)

Business Real Estate and Escrow, A.S.

Basic Business Real Estate Certificate **(CA)**

Business Real Estate Apprentice Certificate **(CP)**

Child Development, A.S.

Early Childhood Education, **AS-T**

Level II: Teacher (Pre-school) **(CA)**

Level I: Associate Teacher (Pre-school) **(CA)**

Level III: Site Supervisor **(CA)**

Communication Studies, AA-T

Computer Information Science, A.S.

Network Specialist Certificate **(CP)**

UNIX Administrator Certificate **(CP)**

Web Authoring Certificate **(CP)**

MySQL Database Developer Certificate **(CP)**

Programming I Certificate **(CA)**

Productivity Software Specialist Certificate **(CA)**

Computer Integrated Design and Graphics A.S.

Architectural CADD Technician I Certificate **(CP)**

Digital Animation Technician I 3ds Max Certificate **(CP)**

Drafting Technician I Certificate **(CP)**

CADD Technician I Certificate **(CP)**

Digital Animation Artist 3ds Max **(CP)**

Expanded Animation Technician 3ds Max Certificate **(CP)**

Digital Filmmaker **(CP)**

Construction Technology, A.S.

Basic Electrician Technician Certificate **(CP)**

Basic Residential Maintenance Technician Certificate **(CP)**

Basic Woodworking Certificate **(CP)**

Building Inspector Certificate **(CA)**

Construction Technology Certificate **(CA)**

Public Works Certificate **(CA)**

Basic HVAC/R Certificate **(CP)**

Basic Machining **(CP)**

Building Construction Certificate **(CA)**

Construction Management Certificate **(CA)**

Plumbing Technician Certificate **(CP)**

Renewable Energy Certificate **(CP)**

Education Technology*

Education Technology Certificate **(CP)**

Electronics Engineering Technology, A.S.

Electronics and Computer Technology, A.S.

Associate Degree Electronics Engineering Technology Certificate **(CA)**

A+ Certification Examination Preparation Certificate **(CP)**

Computer Technology Certificate **(CA)**

Electronic Technology Certificate **(CA)**

N+ Certification Examination Preparation Certificate **(CP)**

MSCSE Examination Preparation Certificate Level I, II **(CP)**

CISCO Networking Academy I, II, III, IV, V, VI, VII

Certificates **(CP)**

Digital Electronics Certificate **(CA)**

Fiber Optic Cabling Technician Certificate **(CP)**

Network Cabling Technician Certificate **(CP)**

Wireless Communication Technology Certificate **(CA)**

Emergency Medical Services, A.S.

Emergency Medical Technician **(Refresher)** Certificate **(CP)**

Paramedic **(CA)**

English, AA-T

Fine Arts, A.A.

This major is recommended for students interested in areas such as the following: Art, Music, Photography, Theatre Arts

Fire Technology, A.S.

Fire Prevention Officer Certificate **(CA)**

Fire Fighter Certificate **(CA)**

Geography, AA-T**History, AA-T****Liberal Arts, A.A.**

*This is usually the major for students who are undecided but who wish to transfer to a university, and/or for those who are interested in areas such as the following: **Anthropology, Economics, English, French, Geography, History, Journalism, Liber-al Studies, Philosophy, Political Science, Psychology, Religious Studies, Sociology, Spanish***

Kinesiology, AA-T**Mathematics, AS-T****Math/Science, A.S.**

*This is usually the major for students interested in areas such as the following: **Anatomy, Astronomy, Biology, Chemistry, Geography, Geology, Mathematics, Microbiology, Oceanography, Physical Education, Physical Science, Physiology, Physics***

Media Arts*

Digital Animation Artist Maya Certificate **(CP)**

Digital Animation Technician I 3ds Max Certificate **(CP)**

Expanded Animation Technician Maya Certificate **(CP)**

Digital Animation Technician I Maya Certificate **(CP)**

Expanded Animation Technician 3ds Max Certificate **(CP)**

Digital Filmmaker **(CP)**

Digital Animation Artist 3ds Max **(CP)**

Medical Assistant, A.S.

Medical Assistant Certificate **(CA)**

Nursing, A.S.

Associate Degree Nursing Certificate **(CA)**

Nursing Licensure Certificate **(CA)**

Paralegal*

Paralegal Studies Certificate **(CA)**

Advance Paralegal Studies **(CP)**

Photography*

Photography Certificate **(CP)**

Psychology, AA-T**Political Science, AA-T**

International Studies Certificate **(CP)**

Respiratory Therapy, A.S.

Respiratory Therapy Certificate **(CA)**

Restaurant Management, A.S.

Restaurant Management Certificate **(CA)**

Sociology, AA-T**Welding, A.S.**

Welding Certificate **(CA)**

* No Associate Degree is awarded in this field.

3D Animation

Do you like to play video games? Do you enjoy movie special effects? Are you the creative type that's looking for a great way to unleash your imagination?

Victor Valley College offers high-end training in 3D Computer Animation for all age levels and skill sets. Courses range from beginning to advanced, with several certificate options available through both the college's Computer Integrated Design and Graphics (CIDG) and Media Arts departments. Beginning classes in both departments require no previous experience.

The field of 3D animation encompasses a wide range of applications, both in the entertainment industry and in business. Most people are familiar with the opportunities that the field of entertainment offers; video games, television commercials and programming, and film-based effects. There are also many other 'practical' applications that many aren't aware of, including opportunities in architecture, mechanical design, the medical field and the courtroom.

Architects use 3D animation to show visual walk-throughs and flybys of new or upcoming projects. Doctors use it in both their practices and training facilities to illustrate a wide range of medical procedures, like knee replacements and heart valve surgery. Lawyers reinforce their court cases using 3D animation; confirming to juries specific details for an insurance lawsuit, or providing forensic evidence for an accident or injury that would otherwise be difficult to visually re-create. Mechanical designers demonstrate how equipment and new innovations work by way of motion graphics. Even the military and NASA take advantage of the benefits of 3D animation; visually depicting military strategies and space exploration that might otherwise go misunderstood.

Victor Valley College's 3D animation courses teach students how to 'use the tool'. Students are then given the flexibility to apply the skills that they've learned in whatever area or discipline they choose. Individuals learn the important core concepts and principles, while being able to concentrate on the applications that most interest them.

New opportunities for skilled 3D animators continue to expand. The field is competitive, as the work is fun and financially rewarding. Although not required in order to be successful, a background in the field of art is helpful. Most importantly, individuals interested in becoming successful as a 3D animator must be willing to use their creativity and imagination. Victor Valley College's 3D Animation program offers a terrific springboard to the possibilities that the industry offers. Come see what all the buzz is about!

3D Animation Careers

3D Animation Careers: Modeler, Texture Artist/Painter, Lighting Specialist, Character Designer, Character Animator, Special F/X Animator, Environment Designer, Game Level Designer, Architectural Animator, Mechanical Design Animator, Medical Visualization Artist, Courtroom Visualization Artist, Web Graphics Animator, Storyboard Artist, Layout Artist, Graphic Designer, Composer

Certificates Awarded

Digital Animation Technician I – 3ds Max - see Computer Integrated Design and Graphics (CIDG)

Digital Animation Artist – 3ds Max - see Computer Integrated Design and Graphics (CIDG)

Expanded Animation Technician I – 3ds Max - see Computer Integrated Design and Graphics (CIDG)

Digital Animation Technician I – Maya - see Media Arts (MERT)

Digital Animation Artist – Maya - see Media Arts (MERT)

Expanded Animation Technician I – Maya - see Media Arts (MERT)

Digital Filmmaker - see Media Arts (MERT)

Transfer

Because of the need for highly-skilled 3D animators, many state college and universities now offer bachelor degrees in Digital Animation. Some have also branched out to offer more specific degrees within the general discipline, like Video Game Designer. Private schools dedicated to the subject of 3D Animation also offer advanced training and degree possibilities. For the most up-to-date information on these programs and others, visit www.assist.org, or for private schools, www.aiccu.edu. Consider stopping by the Transfer Center in Building 55 or making an appointment with a counselor if you have questions. Department instructors can also provide input and additional details.

UC campuses offering 3D Animation include UCLA, USC and Irvine CSU campuses offering 3D Animation include Fullerton, Long Beach, Northridge and Los Angeles Private schools include Academy of Art College, Art Center, The Art Institutes, Cal Arts, Otis College of Art & Design and the Los Angeles Film School

Adaptive Physical Education

Adapted Physical Education (APE) is the art and science of developing, implementing, and monitoring a carefully designed physical education instructional program for a learner with a disability, based on a comprehensive assessment, to give the learner the skills necessary for a lifetime of rich leisure, recreation, and sport experiences to enhance physical fitness and wellness. Federal law mandates that physical education be provided to students with disabilities. Physical Education is defined as the development of physical and motor skills, fundamental motor skills and patterns, skills in aquatics, dance and individual and group games and lifetime sports.

Associate Degree

No associate degree offered with a major in Adaptive Physical Education at the date of this catalog. Adaptive Physical Education courses may be used to fulfill requirements for an Associate in Arts degree with a major in Liberal Arts or Fine Arts. See specific listings for degree requirements.

Adaptive Physical Education Courses

APE 160A INTRODUCTION TO ADAPTED PHYSICAL EXERCISE

Units: 1.0 **CSU, UC** | 48-54 hours laboratory

(Prerequisite: Physical condition limiting participation in regular physical education courses. Medical release applicable. Grade Option) (UC credit limitation)

An introductory individualized fitness program designed to maintain or increase current fitness level. Activities include postural skills, elements of fitness, relaxation and body concepts.

APE 160B INTERMEDIATE ADAPTED PHYSICAL EXERCISE

Units: 1.0 **CSU, UC** | 48-54 hours laboratory

(Prerequisite: Physical condition limiting participation in regular physical education courses. Medical release applicable. Grade Option)

An individualized fitness program designed to maintain or increase current fitness level. Activities include postural skills, elements of fitness, relaxation and body concepts. Medical release required.

APE 160C ADVANCED ADAPTED PHYSICAL EXERCISE

Units: 1.0 **CSU, UC** | 48-54 hours laboratory

(Prerequisite: Physical condition limiting participation in regular physical education courses. Medical release applicable. Grade Option)

An advanced individualized fitness program designed to maintain or increase current fitness level. Activities include postural skills, elements of fitness, relaxation and body concepts.

APE 166A INTRODUCTION TO ADAPTED CARDIOVASCULAR TRAINING

Units: 1.0 **CSU, UC** | 48-54 hours laboratory

(Prerequisite: Physical condition limiting participation in regular physical education courses. Medical release applicable. Grade Option)

This introductory course is designed to meet the needs of students who require restricted or modified activities. Individualized cardiovascular exercise programs will be performed by students with instruction covering the elements of physical fitness. Emphasis will be placed on cardiovascular training principles and techniques.

APE 166B INTERMEDIATE ADAPTED CARDIOVASCULAR TRAINING

Units: 1.0 **CSU, UC** | 48-54 hours laboratory

(Prerequisite: Physical condition limiting participation in regular physical education courses. Medical release applicable. Grade Option)

This introductory course is designed to meet the needs of students who require restricted or modified activities. Individualized cardiovascular exercise programs will be performed by students with instruction covering the elements of physical fitness. Emphasis will be placed on cardiovascular training principles and techniques.

Adaptive Physical Education Courses

APE 166C ADVANCED ADAPTED CARDIOVASCULAR TRAINING

Units: 1.0 **CSU,UC** | 48-54 hours laboratory

(Prerequisite: Physical condition limiting participation in regular physical education courses. Medical release applicable. Grade Option)

This advanced course is designed to meet the needs of students who require restricted or modified activities. Individualized cardiovascular exercise programs will be performed by students with instruction covering the elements of physical fitness. Emphasis will be placed on cardiovascular training principles and techniques.

APE 167A INTRODUCTION TO ADAPTED WEIGHT TRAINING

Units: 1.0 **CSU** | 48-54 hours laboratory

(Prerequisite: Physical condition limiting participation in regular physical education courses. Medical release applicable. Grade Option)

This introductory course is designed to meet the needs of students with disabilities who require restricted or modified activities. Individualized exercise programs will be performed by students with instruction covering the elements of physical fitness through weight training. Emphasis will be placed on principles and techniques.

APE 167B INTERMEDIATE ADAPTED WEIGHT TRAINING

Units: 1.0 **CSU,UC** | 48-54 hours laboratory

(Prerequisite: Physical condition limiting participation in regular physical education courses. Medical release applicable. Grade Option)

This intermediate course is designed to meet the needs of students with disabilities who require restricted or modified activities. Individualized exercise programs will be performed by students with instruction covering the elements of physical fitness through weight training. Emphasis will be placed on principles and techniques.

APE 167C ADVANCED ADAPTED WEIGHT TRAINING

Units: 1.0 **CSU,UC** | 48-54 hours laboratory

(Prerequisite: Physical condition limiting participation in regular physical education courses. Medical release applicable. Grade Option)

This advanced course is designed to meet the needs of students with disabilities who require restricted or modified activities. Individualized exercise programs will be performed by students with instruction covering the elements of physical fitness through weight training. Emphasis will be placed on principles and techniques.

APE 169A INTRODUCTION TO ADAPTED CARDIAC REHABILITATION

Units: 1.0 **CSU** | 48-54 hours laboratory

(Prerequisite: Physical condition limiting participation in regular physical education courses. Medical release applicable. Grade Option)

This introductory course is designed to meet the needs of students with disabilities/special needs who require restricted or modified activities pertaining to the heart. Individualized exercise programs for cardiac rehab students will be performed with instruction covering the elements of cardiovascular fitness. Emphasis will be placed on the special needs of this population.

APE 169B INTERMEDIATE ADAPTED CARDIAC REHABILITATION

Units: 1.0 **CSU,UC** | 48-54 hours laboratory

(Prerequisite: Physical condition limiting participation in regular physical education courses. Medical release applicable. Grade Option)

This intermediate course is designed to meet the needs of students with disabilities/special needs who require restricted or modified activities pertaining to the heart. Individualized exercise programs for cardiac rehab students will be performed with instruction covering the elements of cardiovascular fitness. Emphasis will be placed on the special needs of this population.

Adaptive Physical Education Courses

APE 169C ADVANCED ADAPTED CARDIAC REHABILITATION

Units: 1.0 **CSU,UC** | 48-54 hours laboratory

(Prerequisite: Physical condition limiting participation in regular physical education courses. Medical release applicable. Grade Option)

This advanced course is designed to meet the needs of students with disabilities/special needs who require restricted or modified activities pertaining to the heart. Individualized exercise programs for cardiac rehab students will be performed with instruction covering the elements of cardiovascular fitness. Emphasis will be placed on the special needs of this population.

APE 183A INTRODUCTION TO ADAPTED WALKING FOR FUN FITNESS

Units: 1.0 **CSU,UC** | 48-54 hours laboratory

(Prerequisite: Physical condition limiting participation in regular physical education courses. Medical release applicable. Grade Option)

This introductory course is designed to meet the needs of students who require restricted or modified activities. Individualized cardiovascular exercise programs will be performed by students with instruction covering the elements of physical fitness. Emphasis will be placed on cardiovascular training principles and techniques through walking.

APE 183B INTERMEDIATE ADAPTED WALKING FOR FUN FITNESS

Units: 1.0 **CSU,UC** | 48-54 hours laboratory

(Prerequisite: Physical condition limiting participation in regular physical education courses. Medical release applicable. Grade Option)

This intermediate course is designed to meet the needs of students who require restricted or modified activities. Individualized cardiovascular exercise programs will be performed by students with instruction covering the elements of physical fitness. Emphasis will be placed on cardiovascular training principles and techniques through walking.

APE 183C ADVANCED ADAPTED WALKING FOR FUN FITNESS

Units: 1.0 **CSU,UC** | 48-54 hours laboratory

(Prerequisite: Physical condition limiting participation in regular physical education courses. Medical release applicable. Grade Option)

This advanced course is designed to meet the needs of students who require restricted or modified activities. Individualized cardiovascular exercise programs will be performed by students with instruction covering the elements of physical fitness. Emphasis will be placed on cardiovascular training principles and techniques through walking.

Administration of Justice (Criminal Justice)

All areas of Administration of Justice require that individuals possess the personal and physical qualities essential to become effective peace officers. Many employment opportunities currently exist for individuals desiring entrance into law enforcement or related fields at various governmental levels. Security and corrections are fast-growing professions. Individuals interested in these professions should understand that the work is demanding, requiring a combination of training, education, and experience, along with mental and physical stamina.

The Administration of Justice program is designed to develop a student's understanding of the various operational functions within the criminal justice system. The educational emphasis will be the examination of crime causation, functions of law enforcement, criminal court system, and corrections. Students majoring in this subject area can prepare themselves for careers in law enforcement, corrections, and security at both the operational and administrative levels.

Careers in the criminal justice field are found at the federal, state, county, and city levels.

Careers at the state, county, or city level usually require a high school diploma, but an associate's degree is preferable. Careers in law enforcement usually start with Police Academy Training. The modular format provides the opportunity to become a reserve officer while completing Module II and III of training. A Module I graduate may elect to become a reserve officer or may apply for a full-time position with a law enforcement agency in California.

Careers in Forensics - the application of science and technology to the analysis of physical evidence - may be entered through the Crime Scene Investigation course (AJ 67) and the Fingerprint Recognition and Classification course (AJ 31). CSULA offers a M.A. degree in Criminalistics.

Career Opportunities

Communication Technician, Correctional Officer, Criminalist, Criminologist, Deputy Sheriff, Forensic Technician, Juvenile Correctional Officer, Police Officer, Probation Officer, Security Manager, Security Officer, Special Agent/Investigator

Faculty

Rand Padgett

Degrees and Certificates Awarded

Associate in Science, Administration of Justice

Associate in Science for Transfer, Administration of Justice

Campus Law Enforcement Course PC 832.3 Certificate

Fingerprint Recognition and Classification Certificate

Modular Course Level II Certificate

PC 832 Firearms Only Certificate

Police Technician Specialist Certificate

Administration of Justice Certificate

Corrections Officer Core Course Certificate

Forensic Specialist Certificate

Modular Course Level III Certificate

PC 832 Law Enforcement Course Certificate

Program Learning Outcomes

A student receiving a degree or certificate in this field will be able to:

- Critically analyze and evaluate behaviors and situations for violations of law; evaluate the lawful admissibility of evidence; and assess legal defenses.
- Communicate effectively, orally and in written formats, to the various professional role players within the Criminal Justice system.
- Critically evaluate Vehicle Code violations to determine the cause for an accident.
- Perform the fundamentals of firearm safety, shooting accurately, and cleaning a pistol.
- Critically analyze and assess various sample fingerprints and accurately classify each fingerprint.
- Critically evaluate the search and/or seizure of evidence and determine the admissibility of evidence based on current Federal Supreme Court Decisions.
- Critically analyze and evaluate the procedures in the preliminary investigation of specific crimes.
- Critically examine and evaluate the types of evidence, admissibility of evidence given fourth and fifth amendment restrictions; analyze exceptions to the exclusionary rule.
- Critically evaluate the processes involved in recognizing evidence and investigating any specific crime scene; recognize the barriers to an effective interviews and/or interrogations
- Critically analyze and describe the criminal trial processes from pre-arrest to sentencing.

Administration of Justice (Criminal Justice)

- Critically analyze and evaluate the proper procedures in conducting a criminal investigation involving crimes against persons, property, sex crimes, crimes against children, bombs and explosions, and vice and narcotics.
- Critically evaluate and analyze the development of the role players, training and education, and present day challenges of the criminal justice system to include police, courts, and corrections.
- Perform the duties and responsibilities of a Level II Reserve.
- Critically appraise the legal restraints imposed on a peace officer by the US Constitution; critically evaluate the duties and responsibilities of a Level III Reserve.
- Explain the sociological theories of criminology that relate specifically to juvenile delinquency.
- Recognize and explain the development of the Juvenile court system
- Recognize and explain the role of parens patriae and its role in the social development of the juvenile offender.
- Perform the duties, role, and function of a state certified correctional officer in a county jail or private prison.

Autopsy Assistant Trainee Exam

Students who wish to take the Autopsy Assistant Trainee exam to seek positions as trainees or interns should take **AJ 67, 133, 145; ALDH 139; BIOL 211** (prerequisite: **BIOL 100** or **107**); and **PHOT 101**.

Associate Degree

To earn an Associate in Science degree with a major in Administration of Justice, complete a minimum of 18 units from any of the degree applicable certificate requirements or from any Administration of Justice courses (numbered 50 and above) and meet all Victor Valley College graduation requirements. AJ 138 (Cooperative Education) may be used as elective credit but may not be used to fulfill major requirements

To earn an Associate in Science degree for Transfer with a major in Administration of Justice, complete the required major courses and all other requirements specified on the following pages (ie. 60 CSU transferable units, CSU GE or IGETC, etc). For more information on the AA-T/AS-T degrees, meet with a counselor or go to www.adegreewithaguarantee.com

Transfer

For the most up-to-date information on these programs and others, visit www.assist.org. Please stop by the Transfer Center in Building 55 or make an appointment with a counselor if you have questions.

- **California State University, San Bernardino:** *Criminal Justice major*

Local Bachelors Programs

For information on the following programs located in the High Desert, please visit www.vvc.edu/offices/transfer-center and select "Counseling Information Sheets":

- **Brandman University, Victor Valley Campus:** *Criminal Justice major*
- **University of La Verne, High Desert Campus:** *Criminal Justice major (Online)*

Administration of Justice (Criminal Justice)

Administration of Justice, AS-T (04967)

The program leading to the Associate in Science for Transfer in Administration of Justice is designed to acquaint pre-service and in-service students with the principles and practices of criminal justice systems in America.

Students will be prepared to work in a variety of fields, including: public law enforcement agencies such as municipal police, probation officers, county deputy sheriffs, correctional officers, game wardens, state parks, and private security.

Students completing the AS-T in Administration of Justice will be able to transfer to the California State University system and be prepared to study in the following areas: Administration of Justice, Law Enforcement, Correctional Science, Social Science/Criminology, Forensics, and Pre-Law.

Major Requirements: 18-19 units

Required Courses (6 units total):

AJ 101	Introduction to Administration of Justice	3.0
AJ 103	Criminal Law	3.0

Additional Courses

List A – Select any TWO of the following courses (6 units total)

AJ 102	Criminal Procedures	3.0
AJ 104	Legal Aspects of Evidence	3.0
AJ 132	Introductions to Corrections	3.0
AJ 135	Juvenile Law and Procedures	3.0
AJ 145	Introduction to Criminal Investigation	3.0
AJ 150	Introduction to Forensic Science	3.0
AJ 201	Community and the Justice System	3.0

List B – Select any TWO of the following courses (6 units total)

PSYC 101	Introductory to Psychology	3.0
PSYC 101H	Honors to Introductory Psychology	3.0
SOC 101	Introduction to Sociology	3.0
MATH 120	Introduction to Statistics	4.0
MATH 120H	Honors Introduction to Statistics	4.0
GEOG 101	Physical Geography	3.0
GEOG 101L	Geography Lab	1.0
GEOG 102	Introduction to Cultural Geography	3.0
POLS 130	Introduction to Paralegal Studies	3.0
BADM 101	Financial Accounting	4.0
BADM 103	Financial Accounting Fundamentals	3.0
BIOL 211	Human Anatomy	4.0
CIS 101	Computer Literacy	4.0

OR, any CSU transferable Administration of Justice lower division course, OR, courses outside of the Administration of Justice discipline that are articulated as lower division major preparation for the Criminal Justice/ Criminology major at any CSU.

A student wishing to pursue an AA-T/AS-T degree in the major listed on this page must ensure the CSU of their choice is accepting that similar major. Students completing an AA-T/AS-T degree are guaranteed admissions into a CSU campus given that a student fulfills the following:

- 1) 60 CSU transferable units;
- 2) Completes the CSU General Education (GE) or IGETC General Education pattern;
- 3) Completes the major requirements for the AA-T/AS-T;
- 4) Maintains a transferable cumulative GPA of at least 2.0 (C or better);
- 5) Completes the basic/Golden 4 GE requirements;

For more information on the AA-T/AS-T degrees, meet with a counselor or visit www.adegreewithaguarantee.com

Administration of Justice (Criminal Justice)

ADMINISTRATION OF JUSTICE CERTIFICATE OF ACHIEVEMENT (20548)

Prepares the student for a variety of employment opportunities within the Criminal Justice System. Employment opportunities include Corrections, Law Enforcement, Traffic Enforcement, Probation, Parole, Security, Prevention Loss officer, and related Social Worker positions.

Units Required: 24.0 *All of the following must be completed:*

AJ 92	Writing for Criminal Justice	3.0
AJ 93	Traffic Enforcement and Investigation	3.0
AJ 101	Introduction to Administration of Justice	3.0
AJ 102	Criminal Procedures	3.0
AJ 103	Criminal Law	3.0
AJ 104	Legal Aspects of Evidence	3.0
AJ 127	Introduction to Criminology	3.0
AJ 201	Community and the Justice System	3.0

CAMPUS LAW ENFORCEMENT COURSE: PC 832.3 CERTIFICATE OF CAREER PREPARATION

Units Required: 2.0

AJ 8	PC 832.3 Campus Law Enforcement	2.0
------	---------------------------------	-----

CORRECTIONS OFFICER CORE COURSE CERTIFICATE OF CAREER PREPARATION

Prepares the student to meet the legal requirements established by Standards and Training for Corrections (STC), in order to be employed as a city or county correctional officer.

Units Required: 8.0

FINGERPRINT RECOGNITION AND CLASSIFICATION CERTIFICATE OF CAREER PREPARATION

Units Required: 2.5

AJ 31	Fingerprint Recognition and Classification	2.5
-------	--	-----

FORENSIC SPECIALIST CERTIFICATE OF CAREER PREPARATION

This certificate meets the standards required of a Forensic Specialist whose duties include processing evidence at crime scenes, packaging and transporting evidence to a crime lab, and testifying in court. The certificate requirements meet the standards set by the Commission on Peace Officer Standards and Training and the College Advisory Committee.

Units Required: 3.5

AJ 67	Crime Scene Investigation	3.5
-------	---------------------------	-----

LAW ENFORCEMENT MODULE III BASIC COURSE CERTIFICATE OF CAREER PREPARATION

This certificate will be awarded to students who have successfully completed the Level III Modulated Course. This course is certified by the Commission on Peace Officer Standards and Training.

Units Required: 6.5

AJ 80	Module Law Enforcement Basic Course	6.5
-------	-------------------------------------	-----

Administration of Justice (Criminal Justice)

LAW ENFORCEMENT MODULE II BASIC COURSE CERTIFICATE OF CAREER PREPARATION		
This certificate will be awarded to students who have successfully completed the Level II Modulated Course. This course is certified by the Commission on Peace Officer Standards and Training.		
Units Required: 15.5		
AJ 80	Module III Law Enforcement Basic Course	6.5
AJ 81	Module II Law Enforcement Basic Course	9.0
PC 832 FIREARMS ONLY CERTIFICATE OF CAREER PREPARATION		
Units Required: 0.5		
AJ 30	Firearms Training	0.5
PC 832 LAWS OF ARREST COURSE CERTIFICATE OF CAREER PREPARATION		
Prepares the student to meet the minimum requirements as a non-designated Level III Reserve Peace Officer, or, as a designated limited-duty peace officer. This certificate program complies with the Commission on Peace Officer Standards and Training.		
Units Required: 3.0		
AJ 58	PC 832 Laws of Arrest	3.0
POLICE TECHNICIAN SPECIALIST CERTIFICATE OF CAREER PREPARATION		
Prepares the student for a variety of employment opportunities with any Law Enforcement Agency, in a civilian capacity, as a Forensic Specialist or as an Evidence Technician.		
Units Required: 15.5		
AJ 92	Writing for Criminal Justice	3.0
AJ 93	Traffic Enforcement and Investigation	3.0
AJ 103	Criminal Law	3.0
AJ 140	Communication Skills for Interviewing and Interrogation	3.0
AJ 67	Crime Scene Investigation	3.5

Administration of Justice (Criminal Justice) Courses

AJ 8.0 PC 832.3 CAMPUS LAW ENFORCEMENT

Units: 2.0

32-36 hours lecture

(No Prerequisite. Pass/No Pass) This course does not apply to the Associate Degree.

This course complies with the state requirements for K-12 and Community College peace officer training per Penal Code 832.3g, certified by the State Commission on Peace Officer Standards and Training. This course includes the role and responsibilities of campus police, search and seizure, student discipline and records, crimes against persons and property, mandatory reporting of child abuse, and disaster preparedness.

AJ 25 PUBLIC SAFETY DISPATCHER

Units: 5.5

80-90 hours lecture and 24-27 hours laboratory

(No Prerequisite. Pass/No Pass) This course does not apply to the Associate Degree.

This course complies with the Commission on Peace Officer Standards and Training (POST) requirements for Public Safety Dispatchers. This course includes the criminal justice system, criminal law, communication technology, telephone and radio procedures, missing persons, domestic violence, cultural diversity, sexual harassment, gang awareness, emergency medical services and stress management.

AJ 30 PC 832 FIREARMS

Units: 0.5

24-27 hours laboratory

(Prerequisite. All students must have a DOJ criminal record clearance, in writing through NLETS, CLETS and FBI databases. Pass/No Pass) This course does not apply to the Associate Degree.

This course satisfies the Commission on Peace Officer Standards and Training (POST) firearms certification for the Level III reserve and PC 832. Additionally, this course exceeds the State of California firearms safe handling and use certification required from any person purchasing a firearm in California.

AJ 31 FINGERPRINT RECOGNITION AND CLASSIFICATION

Units: 2.5

40-45 hours lecture

(No Prerequisite. Pass/No Pass) This course does not apply to the Associate Degree.

This course is designed to give instruction and training to a person without any prior knowledge in fingerprint classification. Every person who successfully completes this course will be able to recognize and identify a known fingerprint and have the skills to recognize and identify an unknown fingerprint to known fingerprint.

AJ 58 PC 832 LAWS OF ARREST

Units: 3.0

40-45 hours lecture

(No Prerequisite. Pass/No Pass)

This course complies with the requirements of the Commission on Peace Officers Standards and Training (POST) for certification in PC 832. This course includes professionalism, law, evidence, investigation, arrest methods and control, community relations, and communication skills for interviewing and interrogation.

AJ 64 BASIC CORRECTIONS OFFICER ACADEMY

Units: 8.0

112-126 hours lecture and 48-54 hours laboratory

(No Prerequisite. Pass/No Pass)

This course satisfactorily meets the requirements of section 1020 of the California Administrative Code, Minimum Jail Standards and the Basic Jail/Adult Institution requirements of the STC program.

AJ 67 CRIME SCENE INVESTIGATION

Units: 3.5

48-54 hours lecture and 24-27 hours laboratory

(No prerequisite)

This course concentrates on the technical aspects of evidence collection, crime scene reconstruction, crime scene photography, evidence packaging, and court room testimony. The student is prepared to distinguish between trace, stain, and impression evidence and the role of these types of evidence in criminal investigations.

Administration of Justice (Criminal Justice) Courses

AJ 80 MODULE III LAW ENFORCEMENT BASIC COURSE

Units: 6.5 | 80-90 hours lecture and 72-81 hours laboratory

(Prerequisite: Department of Justice criminal record clearance for firearms (State Mandated). Pass/No Pass)

This course complies with the Commission on Peace Officers Standards and Training (POST) requirements for the Module III Law Enforcement Basic Course. This course includes professionalism and ethics; criminal law; laws of arrest and search and seizure; report writing, vehicle operations; use of force and force options; chemical agents; and firearms training.

AJ 81 MODULE II LAW ENFORCEMENT BASIC COURSE

Units: 9.0 | 120-135 hours lecture and 96-108 hours laboratory

(Prerequisites: AJ 80 and Department of Justice criminal record clearance for firearms. Must have completed Module III within three years and passed the End of Course Final Exam within one year. Pass/No Pass.)

This course includes community relations; victimology; crimes against property and persons; crimes against children; specific sex crimes; search and seizure law; investigative report writing; crimes in progress and patrol tactics; use of force; defensive tactics; and firearms training.

AJ 92 WRITING FOR CRIMINAL JUSTICE (Formerly AJ 133)

Units: 3.0 | 48-54 hours lecture

(No prerequisites)

Techniques of communicating facts, information, and ideas effectively in a simple, clear and logical manner in the various types of criminal justice system reports: letters, memoranda, directives, and administrative reports with an emphasis on criminal justice terminology in note taking and report writing.

AJ 93 TRAFFIC ENFORCEMENT AND INVESTIGATION (Formerly AJ 126)

Units: 3.0 | 48-54 hours lecture

(No prerequisites)

A study of the fundamentals of accident investigation and reconstruction employing the principles of crime scene initial survey, evidence collection, skid mark analysis, and interviewing techniques. Includes the study and application of the California Vehicle code and CHP traffic collision manual.

AJ 101 INTRODUCTION TO THE ADMINISTRATION OF JUSTICE

Units: 3.0 | [CSU, UC](#) | 48-54 hours lecture

(No prerequisites)

This course introduces students to the characteristics of the criminal justice system in the US. Focus is placed on examining crime measurement, theoretical explanations of crime, responses to crime, components of the system, and current challenges to the system. This course will examine the evolution and practices of the police, courts, corrections and their respective role players. This course will examine the ethics, education and training requirements for the respective role players in the criminal justice system.

AJ 102 CRIMINAL PROCEDURES

Units: 3.0 | [CSU](#) | 48-54 hours lecture

(No prerequisites)

Legal processes from pre-arrest through trial, sentencing and correctional procedures. An analysis of ethical decisions made by police, prosecutors, defense attorney, and the judiciary; conceptual interpretations of criminal trial procedural law as reflected in court decisions. A study of case law methodology and case research as the decisions impact upon the procedures of the justice system.

Administration of Justice (Criminal Justice) Courses

AJ 103 CRIMINAL LAW

Units: 3.0 **CSU, UC** | 48-54 hours lecture

(No prerequisites)

This course offers an analysis of the doctrines of criminal liability in the United States and the classification of crimes against persons, property, morals, and public welfare. Special emphasis is placed on the classification of crime, general elements of crime, the definitions of common and statutory law, and the nature of acceptable evidence. This course utilizes case law and case studies to introduce students to criminal law. The completion of this course offers a foundation upon which upper-division criminal justice course will build. This course also includes criminal culpability and defenses to crimes.

AJ 104 LEGAL ASPECTS OF EVIDENCE

Units: 3.0 **CSU** | 48-54 hours lecture

(No prerequisites)

Origin, development, philosophy, and constitutional basis of evidence; constitutional and procedural considerations affecting arrest, search, and seizure; kinds and degrees of evidence and rules governing admissibility and exclusion; judicial decisions interpreting individual rights and case studies viewed from a conceptual level.

AJ 127 INTRODUCTION TO CRIMINOLOGY

Units: 3.0 **CSU, UC** | 48-54 hours lecture

(No prerequisites)

An introduction to major types of criminal behavior, characteristics of offenders, factors which contribute to crime and delinquency. An examination of the criminal justice process; the function of law enforcement, the courts, probation, parole and institutions. Explore the changes in crime control and treatment processes, the role of society.

AJ 130 DEATH INVESTIGATION

Units: 3.0 **CSU** | 48-54 hours lecture

(No prerequisites)

A course designed to prepare the law enforcement officer with the appropriate knowledge and techniques for handling homicide investigations.

AJ 132 INTRODUCTION TO CORRECTIONS

Units: 3.0 **CSU** | 48-54 hours lecture

(No prerequisites)

A survey of the field of correctional science. Historical development, current concepts and practice; explanations of criminal behavior; functions and objectives of the criminal justice system concerned with institutional, probation, and parole processes as they modify the offender's behavior; survey of professional career opportunities in public and private institutions.

AJ 135 JUVENILE LAW AND PROCEDURES

Units: 3.0 **CSU** | 48-54 hours lecture

(No prerequisites)

An overview and history of the Juvenile Justice System that evolved in the American Justice System. This course examines the sociological theories of delinquency, constitutional rights of juveniles, investigative procedures regarding juveniles, and the judicial proceedings of juveniles from intake to custodial resolutions.

AJ 138 COOPERATIVE EDUCATION

See Cooperative Education listing (1-8 units) **CSU**

Administration of Justice (Criminal Justice) Courses

AJ 140 COMMUNICATION SKILLS FOR INTERVIEWING AND INTERROGATION

Units: 3.0 **CSU** | 48-54 hours lecture

(No prerequisites)

The course will focus on the technical and legal aspects of interview and interrogation within the Administration of Justice system. It will provide the student with the communication skills required to elicit reliable and admissible information from witnesses and suspects. Constitutional and Legislative law will be emphasized.

AJ 145 INTRODUCTION TO CRIMINAL INVESTIGATIONS

Units: 3.0 **CSU** | 48-54 hours lecture

(No prerequisites)

This course explores the techniques, procedures, and ethical issues in the investigation of crime, including organization of the investigative process, crime scene searches, interviewing and interrogating, surveillance, source of information, utility of evidence, scientific analysis of evidence and the role of the investigator in the trial process.

AJ 148 SPECIAL TOPICS

See Special Topics listing (Variable units) **CSU**

AJ 149 INDEPENDENT STUDY

See Independent Study listing (1-3 units) **CSU**

AJ 150 INTRODUCTION TO FORENSIC SCIENCE

Units: 3.0 **CSU** | 48-54 hours lecture

(No prerequisites)

This course introduces the role of forensics in the criminal justice system. The course includes: crime scene processes and analysis; interpretation of patterns for reconstruction; physical pattern evidence; fingerprint identification and patterns; questioned document examination; tool marks and firearms examination; biological evidence and DNA; arson and explosives evidence, and drug analysis.

AJ 201 COMMUNITY AND THE JUSTICE SYSTEM

Units: 3.0 **CSU** | 48-54 hours lecture

(No prerequisites)

This course examines the complex, dynamic relationship between communities and the justice system in addressing crime and social conflict with an emphasis on the challenges and prospects of administering justice within a diverse multicultural population. Topics may include ethics, consensus and conflicting values in culture, religion, and law. CSU.

Agriculture and Natural Resources

The Agriculture and Natural Resource (AGNR) Department prepares students with the workforce skills to enter the rapidly evolving career fields in Agriculture and Natural Resource Management. The AGNR department also provides educational pathways to assist students to move on to higher education.

The rapid evolution in the scope and type of these career opportunities are driven by some of the most stringent environmental laws and policy in the world. The implementation of these laws requires innovative thinking, long term planning and sustainable best practice. A new kind of educational approach is needed to prepare applicants with the necessary science, understanding of social/political frameworks, technical expertise and soft skills. It is essential that our society be taught a greater awareness of the need to conserve and wisely manage these resources. Careers in the public and private entities that manage and use these resources are expanding rapidly as the critical nature of these issues becomes more apparent.

Individuals that are trained in agricultural and natural sciences (a High School through University Educational Pathway is being designed in the area), technologies, practices, principles and issues are well positioned to take advantage of these exciting opportunities.

The department has designed its educational programs on the following premises:

1. A focus on the applied sciences (Animal, Soil, Plant and Environmental) that support the disciplines of agriculture and natural resource management.
2. Application of evolving technologies that are essential to manage the complex agriculture and natural resource issues that society faces today. Examples include: natural building, organic gardening, water and soils testing, drip irrigation, ecological restoration, plant propagation, animal ultrasound and artificial insemination, Geographic Information Systems (GIS) and Global Positioning Systems (GPS).
3. Students will become aware of the importance of political and other social sciences that support sustainable development, so that communities can seek an appropriate balance of the environmental, social and economic needs of their region.
4. Increased “hands-on” learning and field experiences. The skills needed to be successful in these areas are best taught through actual experience via laboratories, investigative field experiences, internships, field trips and local case studies.

The department currently focuses on training students in fields of Environmental Horticulture, Plant Science, Habitat Restoration, Landscape Irrigation, Floral Design, Natural Resource Management, Geographic Information Science, Water Resource Management, Equine and Animal Science, and Animal Health.

Career Opportunities

Agribusiness Managers, Economists, Statisticians, Analysts, Journalists, Agriculture and Conservation Extension Officer, Agricultural and Food Inspectors, Agriculture and Natural Resource Educators, Air Quality Monitoring Technicians, Arborists and Tree Pruning Technicians, Environmental and Natural Resource Planner, Farm, Ranch Hands and Managers, Field Biologists, Floral Design Technicians and Floral Shop Managers, Geographic Information System Technicians and Analysts, Golf Course and Turf Grass Managers, Horticulture, Irrigation and Fertilizer Industry Sales, Representatives, Irrigation Consultants and Specialists, Landscape Architects and Designers, Landscape Construction/Installation Contractors, Landscape Maintenance Technicians, Natural Resource Research Technicians, Nursery Technicians and Managers, Organic Practices Advisor, Park and Wildlife Managers, Pest Advisors, Plant Breeders, Propagators and Growers, Solid Waste and Recycling Technicians, Waste Water Technicians, Water Conservation Officers, Water Distribution Technicians, Water, Soils and Biotechnology Lab Technicians, Water Use, Education and Conservation Technicians, Wildlife, Fish and Conservation Biologist, Zoo, City, Country Club and Botanic Garden Horticulturists

Faculty

Neville Slade

Degrees and Certificates Awarded

Associate in Science, Environmental Horticulture
Animal Health Technician Certificate
Equine Science Specialist Certificate
Floral Design Technician Certificate
Horticulture Specialist Certificate
Landscape Specialist Certificate
Plant Science Technician Certificate

Agriculture and Natural Resources Career Exploration Certificate
Animal Science Specialist Certificate
Environmental Horticulture & Restoration Technician
Geospatial Technology Technician Certificate
Irrigation Design Technician Certificate
Natural Resource Management Technician Certificate
Water Resource Management Technician Certificate

Program Learning Outcomes

A student receiving a degree or certificate in this field will be able to:

- Evaluate and communicate analytically including synthesis, and research on the relationship between natural social and economic systems; principles and values that enhance leadership, personal/social responsibility, community involvement and respect for others and the practices that support sustainability.
- Apply complex problem-solving skills and critical thinking using technology, the scientific method, natural resource policy, sustainable practices to current/real-world Agriculture and Natural Resource Management issues.

Associate Degree

To earn an Associate in Science degree with a major in Environmental Horticulture, complete 18 units from any landscape certificates or horticulture coursework, and meet all Victor Valley College graduation requirements. **AGNR 138** (Cooperative Education) may be used as elective credit, but may not be used to fulfill major requirements.

Transfer

For the most up-to-date information on these programs and others, visit www.assist.org. Please stop by the Transfer Center in Building 55 or make an appointment with a counselor if you have questions.

- **University of California, Riverside College of Natural and Agricultural Sciences:**
- **University of California, Davis**
College of Agriculture and Environmental Science
- **California State University**

CSU campuses that offer majors or concentrations in Agricultural Science, Agriculture Business and Management, Environmental Horticulture, Plant Science, Natural Resource Management, Environmental Science, Animal Science include: CSU-Bakersfield, Chico, Fresno, Humboldt, Cal Poly Pomona and San Luis Obispo, San Bernardino, Stanislaus.

Agriculture and Natural Resource

AGRICULTURE AND NATURAL RESOURCES CAREER EXPLORATION CERTIFICATE OF CAREER PREPARATION

Students explore careers in natural resource management and related fields. An introduction to these emerging “Green” careers in: Conservation, Natural Resource Management, Environmental Horticulture, Renewable Energy, Alternative Fuel Systems, Geographical Information Systems, Sustainable Agriculture and Water Management.

Units Required: 12.0

Group I – All of the following must be completed

AGNR 170	Environmental Science and Sustainability	4.0
----------	--	-----

Group II – Two of the following must be completed 5,6,7 or 8 units

AGNR 100	General Animal Science	3.0
----------	------------------------	-----

AGNR 105	Equine Health	3.0
----------	---------------	-----

AGNR 120	Integrated Pest Management	3.0
----------	----------------------------	-----

AGNR 106	Veterinary Terminology and Technology	3.0
----------	---------------------------------------	-----

AGNR 141	Plant Materials and Usage II	3.0
----------	------------------------------	-----

AGNR 152	Introduction to Irrigation and Water Management	3.0
----------	---	-----

AGNR 138	Cooperative Education	2 or 3
----------	-----------------------	--------

AGNR 171	Introduction to GIS in Natural Resources	4.0
----------	--	-----

AGNR 172	Natural Resource Remote Sensing and GIS	3.0
----------	---	-----

AGNR 173	Watershed Management and Restoration	3.0
----------	--------------------------------------	-----

AGNR 175	Sustainable Agriculture, Environment and Society	3.0
----------	--	-----

AGNR 177	Principles of Wildlife Management	3.0
----------	-----------------------------------	-----

AGNR 178	Agriculture Economics	3.0
----------	-----------------------	-----

AGNR 61	Natural Landscape Practices	4.0
---------	-----------------------------	-----

AUTO 89.2	Hybrid Vehicle Maintenance and Service	4.0
-----------	--	-----

CT 142	Renewable Energy Fundamentals	3.0
--------	-------------------------------	-----

ELECT 87	Industrial Control Sys. Devices and Ckts	3.0
----------	--	-----

POLS 206	Introduction to Environmental Policy and Natural Resource Management	3.0
----------	--	-----

GUID 100	Career and Life Planning	2.0
----------	--------------------------	-----

Group III – Complete (3) 1-unit courses or AGNR 74 from the following list

AGNR 74	Honors Introduction to Statistics	6.0
---------	-----------------------------------	-----

AGNR 74A	Sustainable Community Leadership	1.0
----------	----------------------------------	-----

AGNR 74B	Biodiversity Management and Technology	1.0
----------	--	-----

AGNR 74C	Waste and Pollution Management	1.0
----------	--------------------------------	-----

AGNR 74D	Habitat Restoration	1.0
----------	---------------------	-----

AGNR 74E	Sustainable Agriculture Practices	1.0
----------	-----------------------------------	-----

AGNR 74F	Sustainable Building and Energy Practices	1.0
----------	---	-----

Agriculture and Natural Resource

ANIMAL HEALTH TECHNICIAN CERTIFICATE OF CAREER PREPARATION

This specialized certificate prepares the student for employment in the animal care industry. There is strong demand for technicians that understand basic animal husbandry concepts and have the skills to implement emerging technologies, such as ultrasound and artificial insemination.

Upon completion of the certificate the student should be able to:

1. Apply the scientific concepts necessary to understand animal anatomy and physiology.
2. Compare and contrast animal health care practices and their role in disease processes and control.
3. Demonstrate safe handling and training of animals along with appropriate use of tools and equipment.

Units Required: 11.0 or 13.0

Group I – All of the following must be completed

AGNR 100	General Animal Science	3.0
AGNR 105	Equine Health	3.0
AGNR 106	Veterinary Terminology and Technology	3.0

Group II – One of the following must be completed:

AGNR 102	Equine Science	3.0
AGNR 101L	Livestock Feeding and Nutrition	3.0
AGNR 107	Livestock Selection and Evaluation	3.0
AGNR 123	Introduction to Plant Science	3.0
AGNR 131	Introduction to Soil Science	4.0
AGNR 138	Cooperative Education	2 or 3
AGNR 170	Environmental Science	4.0
AGNR 175	Sustainable Agriculture, Environment and Society	3.0
AGNR 177	Principles of Wildlife Management	3.0
AGNR 178	Agriculture Economics	3.0
CHEM 100	Introductory Chemistry	4.0
MATH 120	Introduction to Statistics	4.0

Agriculture and Natural Resource

ANIMAL SCIENCE SPECIALIST CERTIFICATE OF CAREER PREPARATION

Animal production is being asked to be sustainable, more economically, environmentally and socially responsible. In California, rapid housing development and new policies, such as Proposition 2 (the humane treatment of livestock) are encouraging new practices and technologies in all aspects of the industry, from managing animal waste to confined animal housing. A new breed of managers and technicians must adapt to these changes and have the skills to apply these new practices and technologies.

Upon completion of the certificate the student should be able to:

1. Apply the scientific concepts necessary to understand animal anatomy and physiology.
2. Compare and contrast animal health care practices and their role in disease processes and control.
3. Demonstrate safe handling and training of animals along with appropriate use of tools and equipment.

Units Required: 14.0 - 16.0

Group I – All of the following must be completed

AGNR 100	General Animal Science	3.0
AGNR 101L	Livestock Feeding and Nutrition	3.0
AGNR 106	Veterinary Terminology and Technology	3.0
AGNR 107	Livestock Selection and Evaluation	3.0

Group II – One of the following must be completed:

AGNR 102	Equine Science	4.0
AGNR 105	Equine Health	3.0
AGNR 123	Introduction to Plant Science	3.0
AGNR 131	Introduction to Soil Science	4.0
AGNR 138	Cooperative Education	2 or 3
AGNR 170	Environmental Science	4.0
AGNR 175	Sustainable Agriculture, Environment and Society	3.0
AGNR 177	Principles of Wildlife Management	3.0
AGNR 178	Agriculture Economics	3.0
CHEM 100	Introductory Chemistry	4.0
GUID 100	Career and Life Planning	2.0
MATH 120	Introduction to Statistics	4.0
MATH 120H	Honors Introduction to Statistics	4.0

Agriculture and Natural Resource

ENVIRONMENTAL HORTICULTURE AND RESTORATION TECHNICIAN CERTIFICATE OF CAREER PREPARATION

This certificate provides a broad overview of environmental horticulture techniques. Emerging technologies in integrated pest management (IPM), natural soil management, geographical information systems and ecological restoration are emphasized. This certificate prepares the student for entry-level positions within the nursery, recreational, restoration and landscaping industries and focuses on habitat enhancement for wildlife, and human use.

Upon completion of the certificate the student should be able to:

1. Apply the scientific concepts necessary to understand plant anatomy and physiology.
2. Implement the practices, and technological skills necessary to ensure the sustainability of plant agriculture and food production.
3. Demonstrate the safe and appropriate use of plant and horticulture technology tools and equipment.

Units Required: 13.0 - 16.0

Group I – All of the following must be completed

AGNR 121	Equine Science	3.0
AGNR 140	Equine Health	3.0
AGNR 152	Veterinary Terminology and Technology	3.0
AGNR 173	Watershed Management and Restoration	3.0

Group II – One of the following must be completed:

AGNR 60	Horticulture Lab	2.0
AGNR 61	Natural Landscape Practices	4.0
AGNR 74*	Conservation & Sustainability Practices	3.0
AGNR 120	Integrated Pest Management	3.0
AGNR 122	Plant Propagation and Production	3.0
AGNR 123	Introduction to Plant Science	3.0
AGNR 131	Introduction to Soil Science	4.0
AGNR 138	Cooperative Education	2 or 3
AGNR 141	Plant Materials & Usage II	3.0
AGNR 150	Landscape Design	3.0
AGNR 170	Environmental Science	4.0
AGNR 171	Introduction to GIS in Natural Resources	3.0
AGNR 172	Geospatial Technology I	3.0
AGNR 176	Advanced Irrigation Technology	3.0

**Any three of the six, 1-unit modules in AGNR 74(AGNR 74A, B, C, D, E, F)*

Agriculture and Natural Resource

EQUINE SCIENCE SPECIALIST CERTIFICATE OF CAREER PREPARATION

This certificate focuses on basic husbandry, preventative care and veterinary technology in horses. The anatomy and physiology of the horse is studied in comparison to other farm animals to give the student a picture of the need for specialized animal husbandry in the horse.

Upon completion of the certificate the student should be able to:

1. Understand animal anatomy and physiology.
2. Compare and contrast the knowledge of sustainable animal practices, their role in disease processes and control; evaluate the role of preventative veterinary health programs.
3. Demonstrate safe handling and training of animals along with appropriate use of tools and equipment.

Units Required: 12.0

Group I – All of the following must be completed

AGNR 102	Equine Science	4.0
AGNR 105	Equine Health	3.0
AGNR 106	Veterinary Terminology and Technology	3.0

Group II – One of the following must be completed:

AGNR 100	General Animal Science	3.0
AGNR 101L	Livestock feeding and Nutrition	3.0
AGNR 107	Livestock Selection and Evaluation	3.0
AGNR 138	Cooperative Education	2 or 3
AGNR 175	Sustainable Agriculture, Environment and Society	3.0
AGNR 177	Principles of Wildlife Management	3.0
AGNR 178	Agriculture Economics	3.0

FLORAL DESIGN TECHNICIAN CERTIFICATE OF CAREER PREPARATION

This specialized certificate prepares the student for employment in a commercial flower shop as a designer or assistant to the manager. These classes are taught by professionals in the industry and opportunities for success as a florist are unlimited. Whether for fun or profit, floral design is rapidly becoming a growing industry.

Upon completion of the certificate the student should be able to:

1. Plan and prepare floral products for display or resale
2. Demonstrate an understanding of basic floral design theory and construct a minimum of five different floral arrangements and corsages
3. Demonstrate the safe and appropriate use of floral design and horticulture technology tools and equipment

Units Required: 11.0 - 12.0

Group I – All of the following must be completed

AGNR 121	Fundamentals of Environmental Horticulture	3.0
AGNR 160	Beginning Floral Design	3.0
AGNR 161	Advanced Floral Design	3.0

Group II – One of the following must be completed:

AGNR 120	Integrated Pest Management	3.0
AGNR 122	Plant Propagation and Production	3.0
AGNR 123	Introduction to Plant Science	3.0
AGNR 138	Cooperative Education	2 or 3
AGNR 140	Plant Materials & Usage I	3.0
AGNR 141	Plant Materials & Usage II	3.0
AGNR 150	Landscape Design	3.0
AGNR 152	Introduction to Irrigation	3.0
CMST 109	Public Speaking	3.0

Agriculture and Natural Resource

GEOSPATIAL TECHNICIAN CERTIFICATE		
<p>Geospatial Information Science (GIS) is one of the fastest growing industries in the world today. While the rest of the technology sector has been working to recover from economic hardships, the GIS industry has grown to a \$30 billion per year enterprise. The influence and utility of GIS is creating symbiotic relationships and integration throughout industry, business, and government. This certificate is designed to introduce the students to various scientific and theoretical aspects associated with this field. Includes a “hands on” focus where students are introduced to the highly sophisticated software packages through modeling real-world conservation projects with local agencies and businesses.</p> <p>Upon completion of the certificate the student should be able to:</p> <ol style="list-style-type: none"> 1. Demonstrate skills in collecting, assembling and converting natural resource digital data from one format to another 2. Evaluate geospatial data from multiple sources and apply to the design of a basic Geospatial Information System that may be used to answer natural resource management issues and questions 3. Demonstrate the safe and appropriate use of floral design and horticulture technology tools and equipment 		
Units Required: 18.0 - 22.0		
<i>Group I – All of the following must be completed</i>		
AGNR 170	Environmental Science	4.0
AGNR 171	Introduction to GIS in Natural Resources	3.0
AGNR 172	Natural Resource Remote Sensing and Geographic Information Systems (GIS)	3.0
GEOG 101	Introduction to Physical Geography	3.0
<i>Group II – One of the following must be completed:</i>		
AGNR 74*	Conservation & Sustainability Practices	6.0
AGNR 123	Introduction to Plant Science	3.0
AGNR 131	Soil Science	4.0
AGNR 138	Cooperative Education	2.0
AGNR 141	Plant Materials & Usage II	3.0
AGNR 173	Watershed Management and Restoration	3.0
AGNR 175	Sustainable Agriculture, Environment And Society	3.0
AGNR 176	Advanced Irrigation Technology	3.0
AGNR 177	Principles of Wildlife Management	3.0
CIS 96A	Structured Query Language A Using MySQL	2.0
CIS 280	Fundamentals of Database Management Systems	3.0
CTPW 116A	Water Distribution Systems I	3.0
GEOL 103	California Geology	3.0
POLS 206	Introduction to Environmental Policy and Natural Resource Management	3.0
<i>Group III - Complete three 1-unit courses or AGNR 74 from the following list:</i>		
AGNR 74	Honors Introduction to Statistics	6.0
AGNR 74A	Sustainable Community Leadership	1.0
AGNR 74B	Biodiversity Management and Technology	1.0
AGNR 74C	Waste and Pollution Management	1.0
AGNR 74D	Habitat Restoration	1.0
AGNR 74E	Sustainable Agriculture Practices	1.0
AGNR 74F	Sustainable Building and Energy Practices	1.0

Agriculture and Natural Resource

LANDSCAPE SPECIALIST CERTIFICATE OF CAREER PREPARATION

The Landscape Specialist Certificate prepares the student to design, install and maintain landscapes. Focuses on the special challenges of drought tolerant and cold hard landscapes.

Upon completion of the certificate the student should be able to:

1. Be prepared for an entry level career in the Agriculture and Natural Resource Management Industries and/or to transfer to an institute of higher education to further their preparation in one of the applied natural sciences or related disciplines
2. Apply complex problem-solving skills using technology, scientific knowledge/method, natural resource policy, sustainable practices, computer proficiency and industry standard equipment to current/real-world agriculture and natural resource management issues.

Units Required: 14.0-16.0 units

Group I – All of the following must be completed

AGNR 121	Fundamentals of Environmental Horticulture	3.0
AGNR 140	Plant Materials and Usage I	3.0
AGNR 150	Landscape Design	3.0
AGNR 152	Introduction to Irrigation	3.0

Group II – One of the following must be completed:

AGNR 60	Horticulture Lab	4.0
AGNR 120	Integrated Pest Management	3.0
AGNR 122	Plant Propagation and Production	3.0
AGNR 131	Soil Science	4.0
AGNR 138	Cooperative Education	2 or 3
AGNR 141	Plant Materials & Usage II	3.0
AGNR 170	Environmental Science and Sustainability	4.0
AGNR 171	Introduction to GIS in Natural Resources	3.0
CMST 109	Public Speaking	3.0
CT 107	Technical Math	3.0
CT 131	Microcomputers in Construction	4.0

Agriculture and Natural Resource

HORTICULTURE SPECIALIST CERTIFICATE OF ACHIEVEMENT (07532)

The Horticulture Specialist Certificate prepares the student with the basics of establishing and/or managing a horticulture business and a wholesale or retail nursery. This certificate serves as a good crossover for students wishing to enter a natural resource management career.

Upon completion of the certificate the student should be able to:

1. Apply complex problem-solving skills using technology, scientific knowledge/method, natural resource policy, sustainable practices, computer proficiency and industry standard equipment to current/real-world agriculture and natural resource management issues.

Units Required: 23.0- 27.0

Group I – All of the following must be completed

AGNR 120	Integrated Pest Management	3.0
AGNR 121	Fundamentals of Environmental Horticulture	3.0
AGNR 122	Plant Propagation and Greenhouse Production	3.0
AGNR 140	Plant Materials and Usage I	3.0
AGNR 131	Soil Science	4.0
AGNR 141	Plant Materials Usage II	3.0

Group II – Two of the following must be completed:

AGNR 160	Beginning Floral Design	3.0
AGNR 150	Landscape Design	3.0
AGNR 152	Irrigation and Water Management	3.0
AGNR 170	Environmental Science and Sustainability	4.0
AGNR 171	Introduction to GIS in Natural Resources	3.0
AGNR 60	Horticulture Lab	2.0
AGNR 138	Cooperative Education	3.0
CMST 109	Public Speaking	3.0
CT 107	Technical Math	3.0
CT 131	Microcomputers in Construction	4.0

Agriculture and Natural Resource

IRRIGATION DESIGN TECHNICIAN CERTIFICATE OF CAREER PREPARATION

This certificate prepares the student to design, install and maintain irrigation systems. In the face of water shortages in California, irrigation education has shifted to designing water conserving landscapes and the use of technologies that conserve water. The job market remains robust in the agriculture, horticulture, landscape and water conservation industries, given that outdoor water use comprises sixty to seventy-five percent of total water use in most communities.

Upon completion of the certificate the student should be able to:

1. Apply irrigation principles and concepts to create a complete water-efficient irrigation design
2. Demonstrate a thorough understanding and knowledge of irrigation system installation that ensures the sustainability of landscapes and food production
3. Demonstrate the safe and appropriate use of irrigation technology tools and equipment

Units Required: 11.0 - 13.0

Group I – All of the following must be completed

AGNR 121	Introduction to Environmental Horticulture	3.0
AGNR 152	Irrigation and Water Management	3.0
AGNR 176	Advanced Irrigation Technology	3.0

Group II – One of the following must be completed:

AGNR 60	Horticulture Lab	2.0
AGNR 61	Natural Landscape Practices	4.0
AGNR 122	Plant Propagation and Greenhouse Production	3.0
AGNR 123	Introduction to Plant Science	3.0
AGNR 131	Introduction to Soil Science	4.0
AGNR 138	Cooperative Education	2.0
AGNR 140	Plant Materials & Usage I	3.0
AGNR 141	Plant Materials and Usage II	3.0
AGNR 150	Landscape Design	3.0
AGNR 170	Environmental Science and Sustainability	4.0
AGNR 171	Introduction to GIS in Natural Resources	3.0
AGNR 173	Watershed Management and Restoration	3.0
AGNR 175	Sustainable Agriculture, Environment And Society	3.0
CTPW 116A	Water Distribution Systems I	3.0
CTPW 119	Wastewater Operations	3.0

Agriculture and Natural Resource

NATURAL RESOURCE MANAGEMENT TECHNICIAN CERTIFICATE OF CAREER PREPARATION

This certificate prepares students for the emerging “green” careers in industry and with natural resource management agencies such as: The Natural Resource Conservation Service, US Forestry Service, National Park Service, The Bureau of Land Management, and other air and water management agencies. Students will learn the scientific concepts and skills needed to become technicians in: water and soils conservation, habitat restoration, ecological field data collection and interpretation, geospatial technologies, biodiversity management, and sustainable agriculture practices.

Upon completion of the certificate the student should be able to:

1. Evaluate the values and principles that enhance a community wide sustainability ethic
2. Apply scientific knowledge, natural resource policy, sustainable practices, and technology to balance the economic, social and environmental aspects of sustainable development
3. Demonstrate the safe and appropriate use of natural resource management technology, tools and equipment

Units Required: 16.0 - 21.0

Group I – All of the following must be completed

AGNR 170	Environmental Science and Sustainability	4.0
AGNR 172	Natural Resource Remote Sensing and GIS	3.0
AGNR 173	Watershed Management and Restoration	3.0
AGNR 170L	Environmental Science and Sustainability Laboratory	1.0

Group II – One of the following must be completed:

AGNR 74*	Conservation & Sustainability Practices	6.0
AGNR 100	General Animal Science	3.0
AGNR 122	Plant Propagation and Greenhouse Production	3.0
AGNR 123	Introduction to Plant Science	3.0
AGNR 131	Introduction to Soil Science	4.0
AGNR 138	Cooperative Education Agriculture	2 or 3
AGNR 141	Plant Materials and Usage II	3.0
AGNR 171	Introduction to GIS in Natural Resources	3.0
AGNR 173	Watershed Management and Restoration	3.0
AGNR 175	Sustainable Agriculture, Environment and Society	3.0
AGNR 176	Advanced Irrigation Technology	3.0
AGNR 177	Principles of Wildlife Management	3.0
AUTO 89.1	Introduction to Hybrid Vehicle Technology	4.0
BIOL 100	General Biology	4.0
CT 142	Renewable Energy	3.0
ELCT 87	Industrial Control Sys, Devices and Circuits	3.0
FIRE 109	Wildland Fire Control	3.0
POLS 206	Introduction to Environmental Policy and Natural Resource Management	3.0

**Note: Complete three 1-unit courses or AGNR 74 from the following list:*

AGNR 74	Honors Introduction to Statistics	6.0
AGNR 74A	Sustainable Community Leadership	1.0
AGNR 74B	Biodiversity Management and Technology	1.0
AGNR 74C	Waste and Pollution Management	1.0
AGNR 74D	Habitat Restoration	1.0
AGNR 74E	Sustainable Agriculture Practices	1.0
AGNR 74F	Sustainable Building and Energy Practices	1.0

Agriculture and Natural Resource

PLANT SCIENCE TECHNICIAN CERTIFICATE OF CAREER PREPARATION

This certificate is intended to give students a basic understanding of the proper structure and function of plant systems that underlie healthy ecosystems and provide a sustainable food supply. Students learn the scientific concepts of plant breeding, soil science, pest management, proper irrigation methods, ecological restoration practices, sustainable agriculture practices, poly-culture, and natural fertilizers.

Upon completion of the certificate the student should be able to:

1. Understand plant anatomy and physiology
2. Compare and contrast the knowledge of sustainable plant science practices, their role in disease control and integrated pest management programs
3. Demonstrate the safe and appropriate use of plant and horticulture technology tools and equipment

Units Required: 17.0-23.0

Group I – All of the following must be completed

AGNR 122	Plant Propagation and Greenhouse Production	3.0
AGNR 123	Introduction to Plant Science	3.0
AGNR 131	Introduction to Soil Science	4.0
AGNR 141	Plant Materials and Usage II	3.0

Group II – One of the following must be completed:

AGNR 60	Horticulture Laboratory	2.0
AGNR 61	Natural Landscape Practices	4.0
AGNR 74*	Conservation & Sustainability Practices	6.0
AGNR 100	General Animal Science	3.0
AGNR 120	Integrated Pest Management	3.0
AGNR 121	Introduction to Environmental Horticulture	3.0
AGNR 138	Cooperative Education Agriculture	2.0
AGNR 140	Plant Materials & Usage I	3.0
AGNR 150	Landscape Design	3.0
AGNR 152	Irrigation and Water Management	3.0
AGNR 170	Environmental Science and Sustainability	4.0
AGNR 171	Introduction to GIS in Natural Resources	3.0
AGNR 172	Natural Resource Remote Sensing and GIS	3.0
AGNR 175	Sustainable Agriculture, Environment And Society	3.0
AGNR 176	Advanced Irrigation Technology	3.0
AGNR 178	Agriculture Economics	3.0
BIOL 100	General Biology	4.0
CHEM 100	Introductory Chemistry	4.0
GUID 100	Career and Life Planning	2.0
MATH 120	Introduction to Statistics	4.0

**Note: Complete three 1-unit courses or AGNR 74 from the following list:*

AGNR 74	Honors Introduction to Statistics	6.0
AGNR 74A	Sustainable Community Leadership	1.0
AGNR 74B	Biodiversity Management and Technology	1.0
AGNR 74C	Waste and Pollution Management	1.0
AGNR 74D	Habitat Restoration	1.0
AGNR 74E	Sustainable Agriculture Practices	1.0
AGNR 74F	Sustainable Building and Energy Practices	1.0

Agriculture and Natural Resource

WATER RESOURCE MANAGEMENT CERTIFICATE OF CAREER PREPARATION

Focuses on water resource management in the Mojave Desert and makes appropriate linkages to the critical nature of water management in California and around the world. Students explore the economic, political, social and environmental pressures that must be balanced in providing sustainable water supplies. Students also learn the scientific principles and technologies that support watershed restoration, water distribution and management, soil erosion prevention, storm-water management, waste water treatment and water quality.

Upon completion of the certificate the student should be able to:

1. Evaluate the values and principles that enhance a sustainable water supply
2. Apply scientific knowledge, natural resource policy, sustainable practices, and technology to balance the economic, social and environmental aspects of sustainable development.

Units Required: 13.0-17.0

Group I – All of the following must be completed

AGNR 170	Environmental Science and Sustainability	4.0
AGNR 170L	Environmental Science and Sustainability Laboratory	1.0
AGNR 173	Watershed Management and Restoration	3.0
AGNR 178	Agriculture Economics	3.0

Group II – One of the following must be completed:

AGNR 74*	Conservation and Sustainability Practices	6.0
AGNR 121	Fundamentals of Environmental Horticulture	3.0
AGNR 123	Introduction to Plant Science	3.0
AGNR 131	Introduction to Soil Science	4.0
AGNR 138	Cooperative Education	2.0
AGNR 140	Plant Materials & Usage I	3.0
AGNR 141	Plant Materials and Usage II	3.0
AGNR 152	Irrigation and Water Management	3.0
AGNR 171	Introduction to GIS in Natural Resources	3.0
AGNR 175	Sustainable Agriculture, Environment And Society	3.0
AGNR 176	Advanced Irrigation Technology	3.0
CTPW 116A	Water Distribution Systems I	3.0
CTPW 119	Wastewater Operations	3.0
ELCT 87	Industrial Control Systems, Devices and Circuits	3.0
GEOG 130	Introduction to Weather and Climate	3.0
POLS 206	Introduction to Environmental Policy & Natural Resource Management	3.0

**Any three of the six 1 unit modules (AGNR 74A, B, C, D, E, F)*

Agriculture and Natural Resources Courses

AGNR 60 ENVIRONMENTAL HORTICULTURE LABORATORY

Units: 1.0 - 4.0

48-54 hours laboratory per unit, per term.

(No prerequisites)

Horticulture laboratory setting for horticulture students to practice the skills gained from experience and traditional lecture/laboratory classes. This setting will further prepare students for employment in the horticulture industry.

AGNR 61 NATURAL LANDSCAPE PRACTICES

Units: 4.0

64-72 hours lecture.

(No prerequisites)

Introduction to the basics of landscape design; plant material selection; planting and care; composting; irrigation design and maintenance organic and natural methods; soil factors; landscape redesign and renovation; integrated pest management; creating a custom landscape. Emphasis is on the use of water-conserving and resource-efficient practices in establishing functional, attractive landscapes.

AGNR 61C RECYCLING AND THE ESSENTIALS OF COMPOSTING

Units: 0.5

8-9 hours lecture

(No prerequisites)

Students learn how to make productive use of unwanted yard waste and other biomass. Topics include: benefits of composting; the biological process of composting; materials that can and cannot be composted; composting methods; vermiculture; using the finished product as a soil conditioner or mulch, and using other solid waste such as straw and concrete in the landscape.

AGNR 74 CONSERVATION AND SUSTAINABILITY PRACTICES

Units: 6.0

96-108 hours lecture

(No prerequisites)

This course introduces students to the exciting and rapidly expanding practices in the conservation and sustainable use of our natural resources. Local case studies and emerging green technology is presented. Students explore the social, economic and environmental issues that underlie this new frontier in societal development. The Mojave Desert provides a wonderful natural laboratory where many of these sustainability issues can be explored.

AGNR 74A SUSTAINABLE COMMUNITY LEADERSHIP

Units: 1.0

16-18 hours lecture

(No prerequisites)

Students learn to plan, manage and implement sustainable development practices; development that meets the needs of the present generation without compromising the ability of future generations to meeting their own needs. Focus is on the principles of sustainable development that ensure effective leadership and a balance of environmental, social, and economic issues. Extensive use is made of case studies and practical on-site experiences in the Mojave Desert.

AGNR 74B BIODIVERSITY MANAGEMENT AND TECHNOLOGY

Units: 1.0

16-18 hours lecture

(No prerequisites)

The reduction of species diversity is a major indicator of the health of a complete ecosystem. This class explores the science, tools and practice of conserving species diversity. Students learn to implement the exciting tools of Geographic Information Systems (GIS), Global Positioning Systems (GPS), Satellite Imaging and Database Management, along with an understanding of the expanding career opportunities in these fields. Extensive use is made of local Mojave Desert case studies.

AGNR 74C WASTE AND POLLUTION MANAGEMENT

Units: 1.0

16-18 hours lecture

(No prerequisites)

Students study the use of our natural resources on the environmental, social and economic health of our planet. Focus is on emerging careers and technologies for solid waste, green waste and waste water treatment. The consequences of poor management on the quality of our water and air are explored using real-world examples in the Mojave watershed

Agriculture and Natural Resources Courses

AGNR 74D HABITAT RESTORATION

Units: 1.0 | 16-18 hours lecture

(No prerequisites)

Students study ecological restoration that effectively repairs the damage done by human activities to natural habitats. The methodologies appropriate to a particular situation are presented. Topics include: native seed banking, Mycorrhizal relationships, seed stratification and scarification, nutrient requirements, water requirements, transplanting protocols, watershed restoration, soil evaluation and rehabilitation. Case studies will include surface mine reclamation in the Mojave Desert.

AGNR 74E SUSTAINABLE AGRICULTURE PRACTICES

Units: 1.0 | 16-18 hours lecture

(No prerequisites)

Tremendous progress has been made towards farming with nature and restoring ranches to be part of the natural ecosystem. This “farming with the wild” is not only producing more food but enhancing the environment. Students study sustainable practices such as integrated pest management, rotational grazing, organic farming, hedgerows and natural pollination.

AGNR 74F SUSTAINABLE BUILDING AND ENERGY PRACTICES

Units: 1.0 | 16-18 hours lecture

(No prerequisites)

Introduction to renewable energy technology for home use and ecological design. Students study the latest technology to produce energy from the sun, wind, geothermal and biomass.

The sustainable building practices of straw-bale, Super Adobe, Cob, grey-water and solar radiant heating are explored.

AGNR 100 GENERAL ANIMAL SCIENCE

Units: 3.0 | **CSU, UC** | 48-54 hours lecture

(No prerequisites)

A scientific overview of livestock and poultry; highlights anatomy and physiology, reproduction, nutrition, behavior, health, and marketing pertinent environmental and social issues, to include animal welfare. Includes human opportunity to influence trait inheritance, population densities, productivity and sustainability of animal production industry. Focus on technologies that assure efficiency and viability of this industry.

AGNR 101L LIVESTOCK FEEDING AND NUTRITION

Units: 3.0 | **CSU, UC** | 32-36 hours lecture 48-54 hours laboratory

(No prerequisites)

The science of animal nutrition including the fundamentals of digestion and absorption in both ruminants and non-ruminants. Anatomy of large animal digestive systems will be discussed along with feed requirements. Students will formulate rations for a variety of livestock for maximum performance and growth. Laboratory required.

AGNR 102 EQUINE SCIENCE

Units: 4.0 | **CSU, UC** | 48-54 hours lecture

(No prerequisites)

Survey of the equine industry, encompassing the evolution and role of the equine species throughout history, breed selection and development, nutrition, disease, preventative health, reproductive management, basic horsemanship, stabling alternatives and career opportunities. Laboratory required.

AGNR 105 EQUINE HEALTH (Formerly AGNR 50)

Units: 3.0 | **CSU** | 48-54 hours lecture

(No prerequisites. Grade Option)

Students learn the basics of proper veterinary care of the horse, including what to do before the veterinarian is called. Course introduces the diseases and lameness associated with the musculoskeletal system, as well as diseases of the respiratory, digestive, neurological, and reproductive systems. Emphasis is on preventive maintenance and managerial practices needed to keep the equine athlete, broodmare or family horse in good health in the High Desert Region of California.

Agriculture and Natural Resources Courses

AGNR 106 VETERINARY TERMINOLOGY AND TECHNOLOGY (Formerly AGNR 51)

Units: 3.0 **CSU** | 48-54 hours lecture

(No prerequisites)

An introduction to the terminology for drugs, disease and dissection in dogs, cats, horses, ruminants, swine and birds. Basic terminology and function of the skeletal, muscular, digestive, urinary, cardiovascular, respiratory, endocrine, reproductive and nervous systems. Overview of the available technology for animal testing and diagnostic evaluation.

AGNR 107 LIVESTOCK SELECTION AND EVALUATION (Formerly AGNR 55)

Units: 3.0 **CSU** | 48-54 hours lecture

(No prerequisites)

Detailed analysis of various visual and physical methods of appraising beef, sheep, swine and horses concerning functional and economic value. Written and oral summaries of evaluation will be learned. Specific reference will be made to performance data, preparing animals for market and show.

AGNR 120 INTEGRATED PEST MANAGEMENT

Units: 3.0 **CSU** | 32-36 hours lecture 48-54 hours laboratory

(No prerequisites)

Students will learn to employ the principles and concepts of managing insects, diseases and weeds in the landscape and nursery industry. The class will focus on pest identification and the emerging practices of Integrated Pest Management. Effective use of pesticides and weedicides under the existing laws and regulations will be emphasized.

AGNR 121 INTRODUCTION TO ENVIRONMENTAL HORTICULTURE

Units: 3.0 **CSU** | 32-36 hours lecture and 48-54 hours laboratory

(No prerequisites)

Introduction to environmental horticulture with an emphasis on nursery operations, landscaping, turf management, floral design and ecological restoration. Topics include basic plant structure, cultural practices, propagation, landscape structures and layout, seed management, soil analysis, pest management, plant identification, turf grass care and survey of career opportunities.

AGNR 122 PLANT PROPAGATION AND GREENHOUSE PRODUCTION

Units: 3.0 **CSU** | 32-36 hours lecture and 48-54 hours laboratory

(No prerequisites)

Students will explore the challenges of propagation and production of native and drought tolerant plants that are adapted to the extreme climate of the High Desert using techniques commonly used in a professional greenhouse environment. Topics include sexual and asexual propagation techniques. The nursery operations of growing structures, site layout, and preparation of planting media are emphasized.

AGNR 123 INTRODUCTION TO PLANT SCIENCE

Units: 3.0 **CSU** | 32-36 hours lecture and 48-54 hours laboratory

(No prerequisites)

This course provides an introduction to plant science with topics in plant structure and function and the environmental factors involved in plant growth and development. Students will learn: plant physiology, plant reproduction and propagation, effects of soil, water, and climate, use of plants to meet human needs, sustainable horticultural practices, integrated pest management, the role of new technologies in contemporary plant science.

AGNR 131 INTRODUCTION TO SOIL SCIENCE

Units: 4.0 **CSU, UC** | 48-54 hours lecture and 48-54 hours laboratory

(No prerequisites)

The study of soil derivation, classification and characteristics. Soil use and management including erosion, moisture retention, structure, cultivation, organic matter and microbiology. Laboratory topics include soil type, classification, soil reaction, soil fertility and physical properties of soil.

Agriculture and Natural Resources Courses

AGNR 138 COOPERATIVE EDUCATION

See Cooperative Education listing (1-8 units). [CSU](#)

AGNR 140 PLANT MATERIALS AND USAGE I

Units: 3.0 [CSU](#) | 32-36 hours lecture and 48-54 hours laboratory

(No prerequisites)

Students will learn how to identify and use the fascinating array of plants that are appropriate to desert landscapes. Includes identification, growth habits, and cultural requirements of plants common to the California landscape. Trees, shrubs, vines, ground covers, annuals, perennials, and tropical foliage will be covered. Drought tolerant plants will be stressed.

AGNR 141 PLANT MATERIALS AND USAGE II

Units: 3.0 [CSU, UC](#) | 32-36 hours lecture and 48-54 hours laboratory

(No prerequisites)

Identification, growth habits, culture and ornamental use of landscape and indoor plants adapted to climates of California. Plants emphasized will come from the current California Association of Nurseries & Garden Centers (CANGC) and Professional Land care Network (PLANET) Certification Tests Plant Lists. Covers those plants best observed and studied in the fall of the year. Plant materials from local regions will also be included. Laboratory required.

AGNR 150 LANDSCAPE DESIGN

Units: 3.0 [CSU](#) | 32-36 hours lecture and 48-54 hours laboratory

(No prerequisites)

Fundamentals and history of landscape design. Studies of color, texture, form and use of landscape material. Consideration will also be given to proper site layout with regard to existing elevations and conservation management. Emphasis will be on selection and placement of plant material, walks, patios, decks, and other structures for landscape use. Students design and draft actual landscape projects.

AGNR 152 IRRIGATION AND WATER MANAGEMENT

Units: 3.0 [CSU](#) | 32-36 hours lecture and 48-54 hours laboratory

(No prerequisites)

Prepares students to design, install and maintain a water efficient landscape irrigation system. Topics include water supply, basic hydraulics, component identification and terminology, system layout, pipe sizing; types of heads, valves, controllers. Students will gain appreciation for water conservation and quality issues. Students will also learn to troubleshoot irrigation design and electrical problems.

AGNR 160 BEGINNING FLORAL DESIGN

Units: 3.0 [CSU](#) | 32-36 hours lecture and 48-54 hours laboratory

(No prerequisites)

An introduction to the fundamental theories, techniques and skills currently practiced in the floral industry. Includes applied art principles, cut flower care, handling practices, proper use of florist tools and materials, pricing of floral products and use of current floral business technology. Students construct corsages, floral arrangements, and foliage plant items which meet floral industry standards.

AGNR 161 ADVANCED FLORAL DESIGN

Units: 3.0 [CSU](#) | 32-36 hours lecture and 48-54 hours laboratory

(No prerequisites)

Contemporary design theory emphasizing creativity, self-expression, and professional design situations. Students learn the skills and techniques of the floral industry, including wedding, sympathy, party, holiday, high style and advanced floral designs and displays. Other techniques include working with the customers, consultations, pricing and the use of computers.

Agriculture and Natural Resources Courses

AGNR 170 ENVIRONMENTAL SCIENCE AND SUSTAINABILITY

Units: 4.0 **CSU,UC** | 64-72 hours lecture

(No prerequisites)

A study of the applied natural sciences that support the sustainable use and conservation of the world's natural resources including: soil, water, forests, minerals, plant and animal life. Focused on implementing sustainability principles to balance environmental policy, economic stability and social equity to manage modern problems in resource use and global environmental issues. Emphasis on the citizen's role in conservation with particular attention to California conditions.

AGNR 170L ENVIRONMENTAL SCIENCE AND SUSTAINABILITY LABORATORY

Units: 1.0-4.0 **CSU,UC** | 48-54 hours laboratory per unit

(No prerequisites)

Students gain hands-on experience with the concepts and technology that supports environmental science and conservation. Students will learn about the diverse agencies that manage our resources along with their history and philosophies. Each of the major natural resources such as water, air, sustainable building, renewable energy, forests, wildlife, agriculture, and soils will be covered and the environmental policies that govern the use of these resources.

AGNR 171 INTRODUCTION TO GIS IN NATURAL RESOURCES

Units: 3.0 **CSU** | 32-36 hours lecture and 48-54 hours laboratory

(No prerequisites)

Focus on electronic methods of cartography following a presentation of mapping concepts and methods in agriculture and natural resources applications. This course covers the history, structure and uses of the basic operations of Geographic Information Systems (GIS), including hardware and software requirements used in agriculture and natural resources. Examination of the role of other spatial technologies: aerial photography, remote sensing, and Global Positioning Systems (GPS).

AGNR 172 NATURAL RESOURCE REMOTE SENSING AND GEOGRAPHIC INFORMATION SYSTEMS (GIS) (Formerly AGNR 72)

Units: 3.0 **CSU** | 32-36 hours lecture and 48-54 hours laboratory

(No prerequisites)

This course examines geographic information systems (GIS) in an interdisciplinary approach for analysis and decision making in diverse natural resource industries. Aerial photographs, global positioning systems (GPS) and satellite imagery will be used to interpret, recognize and delineate vegetation types, land management practices, wildlife habitat, water resource management and other significant environmental parameters.

AGNR 173 WATERSHED MANAGEMENT AND RESTORATION (Formerly AGNR 73)

Units: 3.0 **CSU** | 48-54 hours lecture

(No prerequisites)

An introduction to the methods, techniques, and tools used to restore and enhance watershed health. This class focuses on water resource management in the West Mojave Desert and makes appropriate linkages to the critical nature of water management in California and around the world. Students explore the economic, political, social, and environmental pressures that must be balanced in providing sustainable water supplies. Students learn the scientific principles that support habitat restoration, groundwater management, soil erosion prevention, and water quality.

AGNR 175 SUSTAINABLE AGRICULTURE, ENVIRONMENT, AND SOCIETY

Units: 3.0 **CSU, UC** | 48-54 hours lecture

(No prerequisites)

This course explores how society is moving away from an industrialized to a sustainable agricultural model. Emphasis on sustainable agriculture's use of technology and the corresponding improvement of the health of the environment, economy, and society.

Agriculture and Natural Resources Courses

AGNR 176 ADVANCED IRRIGATION TECHNOLOGY (Formerly AGNR 76)

Units: 3.0 **CSU** | 48-54 hours lecture

(No prerequisites)

Students will be introduced to the proper steps to design an irrigation system. They will learn about equipment, water management techniques and water quality technology that supports better management of our limited water supply. Exciting new technology in domestic water conservation and water quality will be introduced.

AGNR 177 PRINCIPLES OF WILDLIFE MANAGEMENT

Units: 3.0 **CSU** | 48-54 hours lecture

(No prerequisites)

The study of plant and animal ecology in relation to principles of wildlife management with an emphasis on identification, sexing and aging criteria, wildlife population dynamics, wildlife habitat, and a review of trapping and marking techniques. Students will be introduced to the principles of biodiversity management and the emerging technology of geographic information systems to monitor wildlife populations.

AGNR 178 AGRICULTURE ECONOMICS

Units: 3.0 **CSU** | 48-54 hours lecture

(No prerequisites)

The place of agriculture and farming in the economic system; basic economic concepts, and problems of agriculture; pricing and marketing problems, factors of production; and state and federal farm programs affecting the farmer's economic position.

Alcohol and Drug Studies

Programs in Alcohol and Drug Studies offered at community colleges explore various aspects of alcohol and drug abuse, and teach techniques for counseling those who have a substance abuse problem.

At this time, VVC does not offer a certificate in Alcohol and Drug Studies, but the following courses may fulfill some requirements for the Alcohol/Drug Studies Certificate at San Bernardino Valley College: **ALDH** 125, **ENGL** 101, **PSYC** 101, 108, 125, 133, **SOC** 101, **CMST** 109.

For more information about the Alcohol/Drug Studies program at SBVCC, visit: <https://www.valleycollege.edu/academic-career-programs/degrees-certificates/human-services/alcohol-drug-studies-cert.php>

The Allied Health department offers a variety of independent, non-program classes in health interest areas. Some may enable students to work by completing only one class, such as Medical Insurance, Certified Nursing Assistant, EMT, or Basic Arrhythmias. Others support various medical and secretarial programs or meet general interest needs.

The Paramedic and Medical Assistant programs are administered by the Allied Health Department, but are described in their respective sections found alphabetically in this Catalog.

Career Opportunities

Insurance Biller, Monitor Technician, Nursing Assistant, Phlebotomist

Faculty

Robert Flome | Karmen Padfield | Karen Ray | Carolan Selters
Heidi Shaw | Murray Thale | Debbie Walton | William White

Degrees and Certificates Awarded

Nursing Assistant/Home Health Aide Certificate

Program Learning Outcomes

- Execute basic principles of bedside nursing, including procedures and techniques for basic patient care
- Demonstrate the ability to meet the patient's basic physical and psychological needs and promote a spirit of restoration and independence in a safe, efficient and competent manner

Associate Degree

No associate degree is awarded with a major in Allied Health. Some Allied Health courses fulfill requirements for certificates and majors in Business Education Technologies, Medical Assistant, and Paramedic. See specific programs for certificate and degree requirements. **ALDH 138** (Cooperative Education) may be used as elective credit but may not be used to fulfill major requirements

Transfer

For the most up-to-date information on these programs and others, visit www.assist.org. Please stop by the Transfer Center Not a transfer major. Some Allied Health courses transfer as electives or fulfill subject credit requirements.

NURSING ASSISTANT/HOME HEALTH AIDE CERTIFICATE OF CAREER PREPARATION		
This certificate prepares the student to take the state certification exam for nursing assistant and seek a job in a skilled nursing facility, long term care or home care.		
Units Required: 8.5		
ALDH 60	Nursing Assistant	6.5
ALDH 61	Home Health Aide	2.0
The state-approved certification program enables students to become familiar with basic principles of bedside nursing, including procedures and techniques for basic patient care. Clinical experience is provided in state-licensed, long-term care skilled nursing facilities. Students will learn to meet the patient's basic physical and psychological needs and promote a spirit of restoration and independence in a safe, efficient and competent manner. Entrance to class does not guarantee graduation or certification. Must achieve a grade of "C" or better in theory and clinical portions of the program in order to qualify to sit for the state certification exam.		
Prerequisites: Documented clearance for any crime more serious than a minor traffic ticket. Fingerprints must be obtained upon enrollment in the program and prior to patient contact. State regulations require documented proof of students' ability to speak, read, write, and comprehend the English language at the sixth grade level. A mandatory orientation is scheduled before the semester begins; please check with the department for upcoming dates and times. Class enrollment is not necessary to attend orientation meeting		
Co-requisite: Healthcare Provider CPR card must be current at the end of the program.		

Allied Health Courses

ALDH 60 NURSING ASSISTANT

Units: 6.5

64-72 hours lecture and 120-135 hours laboratory - Offered Fall, Spring

(Prerequisites: Documented clearance for any crime more serious than a minor traffic ticket. Fingerprints must be obtained upon enrollment and DOJ clearance obtained. Health exam prior to clinical rotation. CPR certification from an American Heart CPR provider course.)

Enables students to become familiar with basic principles of nursing, including procedures and techniques. Clinical experience is provided in extended care facilities. Students will learn to provide and meet the patient's basic physical and psychological needs and promote a spirit of restoration and independence in a safe, efficient, and competent manner. State approved precertification program. Does not guarantee certification. Must achieve a grade of "C" or better to take state certification examination.

ALDH 61 HOME HEALTH AIDE

Units: 2.0

24-27 hours lecture and 24-27 hours laboratory.

(Prerequisites: Must have current and active California CNA certificate. Students who have completed Victor Valley ALDH 60 Nursing Assistant course this semester, but have not completed the state exam may enter the course. State Home Health Aide certification will be contingent upon passing the State CNA Certification Exam. Co-requisite: Current Healthcare Provider CPR card.)

Enable students to become familiar with basic principles of nursing care in a home style setting. Clinical experience is provided in residential care facilities. Students will learn to provide and meet the patient's basic physical and psychological needs and to promote a spirit of rehabilitation and independence in a safe, efficient and competent manner. State approved certification course. A grade of C or above must be earned to receive state certification.

ALDH 62 ACUTE CARE CNA

Units: 4.5

48-54 hours lecture and 72-81 hours laboratory

(Prerequisites: Must have a current and active State of California Certificate for Nursing Assistant (CNA). Students that have completed Victor Valley ALDH 60 Nursing Assistant course, but have not completed the state exam may enter the program. Certification of completion by Victor Valley College will be contingent upon the student also passing the State CNA Certification exam. Co-requisite: Current Healthcare Provider CPR card.)

This course will allow the Certified Nursing Assistant to expand upon basic nursing practices to include those specific for the acute care setting. Clinical experience is provided in acute care facilities. Students will learn nursing practice skills related to the medical-surgical patient and will have an understanding of physical and psychosocial changes seen in the acute setting. Also introduces the student to ancillary departments and provides an opportunity for student to learn how all departments work together to care for patients. Must achieve a grade C or better to receive Victor Valley College Certification

ALDH 80 PHARMACOLOGY

Units: 3.0

48-54 hours lecture

(No prerequisite)

Current concepts of pharmacology, its relationship to patient care, and legal and ethical considerations are covered. Basic mechanisms of drug action, administration, toxicity, side effects, and dosages are also included.

ALDH 81 MEDICAL INSURANCE

Units: 3.0

48-54 hours lecture

(No prerequisite)

This course is designed to introduce and acquaint students to the basics of medical insurance, the billing process, including insurance terminology, medical coding systems, government and private payer health care claims, industrial, managed care insurances, general insurance procedures, and basic knowledge of billing/collection procedures.

ALDH 82 MEDICAL OFFICE PROCEDURES *(Medical Assistant)*

Units: 4.0 | 48-54 hours lecture. 48-54 laboratory

(No prerequisite)

This course provides practice in medical office procedures, proficiency in typing medical correspondence, case histories, insurance forms, and reports. Study of telephone techniques, medical record-keeping, and filing. Verbal communication with patients, other offices, and facilities. In addition, a lab component for students to become familiar with preparation and assistance with common back office procedures.

ALDH 82C MEDICAL OFFICE PROCEDURES – CLINICAL *(Medical Assistant)*

Units: 5.0 | 240-270 hours laboratory

(Prerequisite: ALDH 82 with a grade of 'C' or better.)

This course is designed to provide the externship component of Allied Health 82, Medical Office Procedures. The individual students will be presented with 270 hours of practical clinical experience. This will be performed in rotation sequence in the offices and clinics of qualified physicians located throughout the High Desert.

ALDH 83 BASIC ARRHYTHMIA

Units: 3.0 | 48-54 hours lecture

(No prerequisite)

A review of the general anatomy and physiology of the heart and coronary system, with complications associated with acute myocardial infarction with strong electrophysiological/arrhythmogenic component. Upon successful completion, the student will receive a certificate in Basic Electrocardiography and Arrhythmia Interpretation. (This course has been approved by the Board of Registered Nursing for Continuing Education credit.)

ALDH 125 MEDICAL ASPECTS OF DRUGS AND ALCOHOL

Units: 3.0 | **CSU, UC** 48-54 hours lecture

(No prerequisite) (UC credit limitation)

This course will provide an in-depth study of the physiological effects and medical consequences of drug and alcohol use and abuse, including the effects on the central nervous system and behavior. The pharmacological aspects of drug and alcohol use will be presented including metabolism of various drugs, the meaning and implication of "half-life", tolerance, dependence, addiction process, and withdrawal. Categories of substances covered will include major and minor stimulants, alcohol, depressants, psychotropic drugs, opiates, marijuana, hallucinogens, and other prescription and over-the-counter drugs.

ALDH 138 COOPERATIVE EDUCATION

See Cooperative Education listing (1-8 units). **CSU**

ALDH 139 MEDICAL TERMINOLOGY

Units: 3.0 | **CSU** 48-54 hours lecture

(No prerequisite)

This course describes the body's anatomical systems with stress placed on medical terms, their use, spelling, and pronunciation. The use of these terms is defined in regard to anatomy, physiology, treatment, and surgery.

ALDH 141 ATHLETIC TRAINING

Units: 3.0 | **CSU, UC** 32-36 hours lecture and 48-54 hours laboratory

(No prerequisite. Recommended preparation: Interest and/or experience in athletics and sports.)

Introduction to principles of athletic training, including prevention, evaluation, treatment, and rehabilitation of common athletic injuries. See cross listing for PE /KIN 141.

ALDH 142 ATHLETIC TRAINING II

Units: 3.0 | **CSU, UC** 32-36 hours lecture and 48-54 hours laboratory

(Prerequisite: ALDH 141 or PE/KIN 141 Athletic Training I, or equivalent.)

This course will build on the student's basic knowledge of human anatomy and athletic injuries. Topics will include emergency procedures, current health concerns of the athlete, protective devices, advanced taping techniques and injury management. See cross-listing for KIN 142.

Allied Health Courses

ALDH 148 SPECIAL TOPICS

See *Special Topics listing (Variable units)*. **CSU**

ALDH 149 INDEPENDENT STUDY

See *Independent Study listing (1-3 units)*. **CSU**

ALDH 176 ATHLETIC TRAINING III

Units: 2-6.0 **CSU, UC** | **108-324 hours laboratory**

(Prerequisite: ALDH 141 or PE/KIN 141 Athletic Training I, or equivalent).

In this course, students will provide the pre-participation, on-site first aid and event maintenance for fall/winter/spring sports programs at VVC (baseball, basketball, football, golf, soccer, softball, tennis, volleyball and wrestling.) Experience will include but is not limited to, prophylactic taping and padding, immediate first aid, monitoring vital signs, completion of accident forms, proper use of universal biohazard precautions, supervision of safe playing conditions and coaching techniques, recognition of medical emergencies, assisting other medical personnel as needed, game preparation and pre-participation medical screenings. See cross-listing for **KIN 176**.

ALDH 177 ATHLETIC TRAINING IV

Units: 2-6.0 **CSU, UC** | **108-324 hours laboratory**

(Prerequisite: ALDH 141 or PE/KIN 141, Athletic Training I, or equivalent.)

In this course, students will provide the care to athletes involved in fall/winter/spring sports programs at VVC (baseball, basketball, football, golf, soccer, softball, tennis, volleyball, and wrestling.) Experience will include but is not limited to development and implementation of rehabilitation protocols. Use of modalities including, whirlpool, ultrasound, ice, Emergency Medical Services, hydrocolator packs, Range of Motion exercises, joint mobilization, strengthening exercises (isokinetic, isotonic, isometric), cardiovascular conditioning and proprioceptive exercises. See cross-listing for **KIN 177**.

American Sign Language

American Sign Language Courses

ASL 121 FINGERSPELLING

Units: 1.0 **CSU** | 16-18 hours lecture

(No prerequisites)

An introductory course that teaches the student the appropriate application of fingerspelling and its production. The course will include strategies for improvement. Also included will be the articulation of loan signs and one to three digit numbers. Emphasis on both receptive and expressive fluency.

ASL 122 AMERICAN SIGN LANGUAGE I

Units: 4.0 **CSU, UC** | 64-72 hours lecture

(No prerequisites)

An introduction to American Sign Language as it is used with deaf community. Students will study the basic structure and development of the language as well as deaf culture. Emphasis is placed on both receptive and expressive skills

ASL 123 AMERICAN SIGN LANGUAGE II

Units: 4.0 **CSU, UC** | 64-72 hours lecture

(Prerequisite: ASL 122)

A continuation in the study of American Sign Language as it is used within the deaf culture. Instruction is provided in the basic structure of the language. Emphasis is placed on both receptive and expressive skills.

ASL 124 AMERICAN SIGN LANGUAGE III

Units: 4.0 **CSU, UC** | 64-72 hours lecture

(Prerequisite: ASL 123)

Continuation of development of skill in American Sign Language with emphasis on an intermediate level of comprehension and expression. Students will progress in their study of the structure and grammar of American Sign Language as well as deaf culture. Emphasis is placed on both receptive and expressive skills.

ASL 125 AMERICAN SIGN LANGUAGE IV

Units: 4.0 **CSU, UC** | 64-72 hours lecture

(Prerequisite: ASL 124)

A continuation in the study of American Sign Language and the deaf community including its history and culture. Emphasis will be on receptive and expressive skills as they relate to narrating life events. Students will learn techniques such as role-shifting, use of space and classifiers in addition to appropriate non-manual behaviors. This course will prepare the student for entrance into an interpreter training program.

ASL 126 INTRODUCTION TO INTERPRETING

Units: 4.0 **CSU** | 64-72 hours lecture

(Prerequisite: ASL 125. Grade Option)

This course introduces the field of American Sign Language interpreting and includes models of interpreting, ethical principles, and its history and development in modern times. Attention will be given to the development of necessary processing skills for consecutive interpretation.

Anthropology

Training in anthropology will prepare one for any career that involves working on the interface between cultures. Specialized preparation in this subject can lead to some of the world's most interesting work - the study of existing life ways, archaeological excavation and interpretation, primate behavior, and social research into economics, politics, law, religion, art, and music.

Career Opportunities

Careers in anthropology are diverse, specialized, and related to the various areas of concentration which are offered at four-year college and universities: Listed below are just a few examples:

Archaeologist - Federal/State/Private, Cultural Resource Management, Environmental Impact Analyst, Expedition Guide, Forensic Anthropologist, Health Researcher, Museum Curator/Exhibit Designer, Population Analyst, Urban Planner Analyst, Political Attaché, Interpreter, Documentarian, Rural Studies, Urban Studies, Osteologist, Behavior Analyst, Economic Analyst, Civil Right Activist.

Faculty

Richard Cerreto

Degrees and Certificates Awarded

Associate in Arts, Liberal Arts

Associate Degree

No associate degree awarded with a major in Anthropology. Anthropology courses may be used to fulfill requirements for an Associate in Arts degree with a major in Liberal Arts and various ADTs. Please see the various department listings for degree requirements

Transfer

For the most up-to-date information on these programs and others, visit www.assist.org. Please stop by the Transfer Center in Building 55 or make an appointment with a counselor if you have questions.

- **California State University, San Bernardino:** Anthropology major
- **University of California, Riverside:** Anthropology major

Anthropology Courses

ANTH 101 INTRODUCTION TO PHYSICAL ANTHROPOLOGY

Units Required: 3.0 **CSU, UC** | 48-54 hours lecture

(No prerequisite. Grade Option)

Biological anthropology explores the biological development and adaptations of humans in relation to their different natural environments through the biocultural approach. This course provides information on how and why human populations vary within and between themselves; how and why humans have changed biologically and behaviorally through time; physical and behavioral comparisons between human and non-human primates; and biological and behavioral/technological development from the earliest to modern humans.

ANTH 101L PHYSICAL ANTHROPOLOGY LABORATORY

Units Required: 1.0 **CSU, UC** | 48-54 hours laboratory

(Co-requisite: ANTH 101. Grade Option)

Coordinated with the lecture, this optional lab provides hands-on experience in human genetics, variation, and evolution; comparisons of non-human primate behavior; knowledge of the human skeleton and forensic identification methods.

Anthropology Courses

ANTH 102 INTRODUCTION TO CULTURAL ANTHROPOLOGY

Units: 3.0 [CSU, UC](#) | 48-54 hours lecture

(No prerequisite. Grade Option)

Cultural anthropology explores the social aspect of being human, in context with the multicultural approach. This course provides comparisons of all aspects of culture such as societal organization, economy, marriage and family, language development, gender issues, religion, and traditions and rituals. The development and evolution of cultural groups is discussed in relation to how several of these groups successfully adapt to particular environments. Drawing from anthropology and other social sciences, the history and development of the modern World System and its effect on culture groups worldwide is outlined.

ANTH 103 INTRODUCTION TO ARCHAEOLOGY

Units: 3.0 [CSU, UC](#) | 48-54 hours lecture

(No prerequisite. Grade Option)

Archaeology is the study of human groups in the context of their historic and prehistoric past. Through excavation of archaeology sites and laboratory analysis, archaeologists investigate and reconstruct the time frame, the life activities, and technological changes of ancient cultures. This course provides information on the history and development of archaeology, the archaeological methods used to excavate sites, how archaeologists relate the artifacts and other remains found on the sites to human behavior, how the sites within a region relate to each other and the natural surroundings, and the theoretical framework that helps to explain the behavioral and technological changes through time.

ANTH 103F ARCHAEOLOGY FIELD CLASS

Units: 3.0 [CSU](#) | 32-36 hours lecture and 48-54 hours laboratory

(No prerequisite. Grade Option)

This course provides the student with hands-on experience in the excavation and investigation of an archaeology site and the materials contained in archaeology sites, the archaeological methods used to excavate sites, and how archaeologists relate the artifacts and other remains found on the sites to human behavior.

ANTH 103L ARCHAEOLOGY LAB

Units: 3.0 [CSU](#) | 16-18 hours lecture and 96-108 hours laboratory.

(No prerequisite. Grade Option)

This course is designed as a laboratory class that compliments the Archaeology Field Course. The class introduces the students to laboratory work in archaeology, providing hands-on experience. Students learn to process the materials collected from the field class archaeology site, from cleaning and identification to their analysis.

ANTH 106 INTRODUCTION TO LINGUISTIC ANTHROPOLOGY

Units: 3.0 [CSU, UC](#) | 48-54 hours lecture

(No prerequisite. Grade Option)

This course examines human language systems and their significance in social context. Topics that will be covered include the origins and evolution of language; nonhuman primate communication systems; language classification; language structure; semantic systems; the social and cultural function of language; language acquisition; language change and the reconstruction of language at earlier stages.

ANTH 107 INTRODUCTION TO FORENSIC ANTHROPOLOGY AND ARCHAEOLOGY

Units: 3.0 [CSU](#) | 48-54 hours lecture

(No prerequisite. Grade Option)

This course is designed to introduce the student to the specialty fields of forensic anthropology and forensic archaeology. Through lecture and hands-on experience, the student will become familiar with archaeological field methods and many of the basic techniques used by forensic anthropologists.

ANTH 128 SPECIAL TOPICS

See Special Topics listing (Variable units). [CSU](#)

Architecture

Victor Valley College does not offer an Architecture program for transfer but does however offer preparatory courses for transfer into a School of Architecture. These courses are offered through our Computer Integrated Design and Graphics (CIDG) Department. Students can obtain Architecture related certificates that will prepare them to enter into a school of Architecture at the university level with an Associate in Science degree in CIDG or go directly into the workforce.

An architect develops concepts for design projects which range from single objects such as a piece of furniture, designing homes to complex high-rise office buildings. Our Architecture program is centered on learning the necessary software programs that are used in architectural studios across the country. You will also have a design laboratory experience with students progressing toward comprehensive architectural projects, model building and rendering. Architecture is an impacted major at some universities. As a result, students need to maintain a high GPA, complete as many course requirements as possible before applying for admission, and research all additional program requirements for specific colleges to which they will be applying. A portfolio of each prospective student's work is usually required with the application. Therefore, students need to contact the college of choice early in their education to assure proper preparation and presentation of their work.

Transfer

To pursue a bachelor's degree in this field, here are some schools that have programs that might interest you. For the most up-to-date information on these programs and others, visit www.assist.org, or, for private schools, www.aiccu.edu. Please stop by the Transfer Center in Building 55 or make an appointment with a counselor if you have questions.

- **UC campuses offering Architecture include Berkeley and UCLA**
- **CSU campuses that offer Architecture include Pomona, San Luis Obispo and Chico**
- **Private schools include University of Southern California (USC), New School of Architecture and Design San Diego, California College of the Arts, San Francisco, and Academy of Art University San Francisco**

Degrees and Certificates Awarded

Associate in Science, CIDG

Drafting Technician I Certificate

CADD I Technician I Certificate

Architectural CADD Technician I Certificate

CAD Careers

Architect, Architectural Drafter, CAD Management, CAD Operator, Cabinet Shop Detailer, Civil Drafter, Computer Electrical Drafter, Electronics Drafter, Graphics Designer, Interior Designer, Landscape Architect, Landscape Designer, Mechanical Drafter, Public Works Technician, Steel Fabricator Drafter, Structural Drafter, Technical Illustrator

Note: Associate of Science Degree programs require completion of at least 60 units of credit, which normally will take 4 semesters. Certificate programs, many of which lead to an Associate of Science degree, vary in the number of units required. Most can be completed in 2 - 4 semesters. Each course required for a certificate must be completed with a "C" grade or better. All can be counted toward its related degree.

Art and Design

Art and design are an integral part of our daily lives as creative expression and as commercial applications. Humankind is reflected in great works of art throughout time, depicting our deeds and actualization. A study in art and design will lead to the development of a diverse range of career possibilities that span from self-expression to commercial design.

Students may choose a program leading to an AA degree, and courses in art are transferable to four-year colleges. Consult with the department chairperson for specialized areas of interest.

Career Opportunities

Advertising, Architectural Designer, Commercial Artist/Graphic Designer, Computer Graphics/Imaging/Animation, Film Maker, Interior Designer, Medical Illustrator, Photographer/Fine-Art, Commercial, Theatre Set Designer, Video Director.

Faculty

Frank Foster | Richard Ripley

Degrees and Certificates Awarded

Associate in Arts, Fine Arts

Associate in Arts, Liberal Arts

Associate Degree

No associate degree awarded with a major in Art. Art courses may be used to fulfill requirements for an Associate of Arts degree with a major in Fine Arts or Liberal Arts. See Fine Arts or Liberal Arts for degree requirements for these majors. ART 138 (Cooperative Education) may be used as elective credit, but may not be used to fulfill major requirements.

Transfer

To pursue a bachelor's degree in this field, here are some schools that have programs that might interest you. For the most up-to-date information on these programs and others, visit www.assist.org. Please stop by the Transfer Center in Building 55 or make an appointment with a counselor if you have questions.

- California State University, San Bernardino: Art major
- University of California, Riverside: Art major

Art and Design Courses

ART 101 SURVEY OF ART HISTORY

Units: 3.0 **CSU, UC** | 48-54 hours lecture

(No prerequisites)

An historical survey of significant art from prehistoric times through the fourteenth century.

ART 102 SURVEY OF ART HISTORY

Units: 3.0 **CSU, UC** | 48-54 hours lecture

(No prerequisites)

An historical survey of significant art from the Renaissance through modern times.

ART 103 THE ART OF AMERICAN CINEMA

Units: 3.0 **CSU, UC** | 48-54 hours lecture

(No prerequisites)

This class traces the development of cinema in America from silent to contemporary films. The course will address the evolution of moving images as an expression of art and meaning.

Art and Design Courses

ART 104 FILM AS AN ART FORM

Units: 3.0 CSU, UC | 48-54 hours lecture

(No prerequisites)

Film as a form of art and its construction as a communicative, expression of global culture, politics, literature and gender will be studied. Important films will be viewed that address these topics. Students will learn to be more critical viewers of media and its presentation of world culture.

ART 105 INTRODUCTION TO ART

Units: 3.0 CSU, UC | 48-54 hours lecture

(No prerequisites)

This course is a general introduction to the visual arts, its nature, vocabulary, media, and history. The course examines the historical and contemporary value of art to both the individual and society. Consideration will also be given to a study of the organization and component parts of the visual art and the various media used in the making of art.

ART 106 ART CONCEPTS

Units: 3.0 CSU, UC | 48-54 hours lecture

(No prerequisites)

This lecture course will introduce students to the practice, theory and history of art. The course will also investigate the impact art has upon our contemporary society.

ART 107 THE ART AND LIFE OF GREECE

Units: 3.0 CSU, UC | 48-54 hours lecture

(No prerequisites)

This is an illustrated lecture course focusing on art of the ancient Greek world from c. 1100 BCE to the 1st Century. Emphasis is placed upon analysis of the various styles of Greek art from the formative period of Hellenism. The art works are studied and analyzed within the cultural/historical context of the Greek world including mythology, philosophy, and social structure as these relate to the development of Greek art.

ART 108 THE ART AND LIFE OF ITALY

Units: 3.0 CSU, UC | 48-54 hours lecture

(No prerequisites)

This is an illustrated lecture course focusing on the arts of Ancient Rome and the influence Rome had upon the development of the Western art world. This course focuses on the role of the Etruscans in the development of the early arts of the Roman Empire including the changes brought by the influence of Christianity. The later development of the arts of Italy will also be covered.

ART 109 SURVEY OF AFRICAN AMERICAN ART

Units: 3.0 CSU, UC | 48-54 hours lecture

(No prerequisites)

This course will survey the arts of the African peoples in diaspora from traditional African arts to contemporary times. Focus will be on identification of artists, art styles within their historical, cultural, political framework and exploration of aesthetic preferences.

ART 112 DESIGN I

Units: 3.0 CSU, UC | 32-36 hours lecture and 48-54 hours laboratory

(No prerequisites)

This course will focus on the basics of design utilizing the principles and practices involved in the production of art forms.

ART 113 DESIGN II

Units: 3.0 **CSU, UC** | 32-36 hours lecture and 48-54 hours laboratory

(No prerequisite. Recommended preparation: ART 112)

A continuation of Art 112 utilizing the same art concepts, aesthetic elements, and principles of design expanded to three-dimensions.

ART 114 COLOR THEORY

Units: 3.0 **CSU, UC** | 32-36 hours lecture and 48-54 hours laboratory

(No prerequisite)

This course traces the development of color theory and provides exercises in color and design in a variety of media that have practical applications in the visual arts profession.

ART 115 WATER-BASED MEDIA

Units: 3.0 **CSU, UC** | 32-36 hours lecture and 48-54 hours laboratory

(No prerequisite. Recommended preparation: ART 125)

This is an introductory course in water-based painting media with an emphasis in foundational painting techniques including, process, color theory, visual perception, composition and creative skills. Students will pay for their own supplies.

ART 120 ACRYLIC PAINTING I

Units: 3.0 **CSU, UC** | 32-36 hours lecture and 48-54 hours laboratory

(No prerequisite. Recommended preparation: ART 112 or ART 113 or ART 125.)

This course is an introduction to acrylic painting with an emphasis on color mixing, modeling, composition, likeness, and application of general design principles.

ART 121 ACRYLIC PAINTING II

Units: 3.0 **CSU, UC** | 32-36 hours lecture and 48-54 hours laboratory

(No prerequisite. Recommended preparation: ART 120.)

This is an intermediate course in acrylic painting with continuing study of the theory and practice of painting.

ART 122 LIFE DRAWING I

Units: 3.0 **CSU, UC** | 32-36 hours lecture and 48-54 hours laboratory

(No prerequisite. Recommended preparation: ART 125 or ART 126)

A beginning life drawing course emphasizing the study and analysis of the human form using basic art materials and fundamental drawing concepts.

ART 123 LIFE DRAWING II

Units: 3.0 **CSU, UC** | 32-36 hours lecture and 48-54 hours laboratory

(No prerequisite. Recommended preparation: ART 125 or ART 126, or ART 122.)

An intermediate life drawing course emphasizing the continued study and analysis of the human form using drawing of the human figure from life.

ART 124 ANATOMY FOR LIFE DRAWING

Units: 3.0 **CSU, UC** | 32-36 hours lecture and 48-54 hours laboratory

(No prerequisite. Recommended preparation: ART 122 or ART 123 or ART 125 or ART 126.)

Critical dissection of anatomical and physiological studies incorporated into the fine art of life drawing.

Art and Design Courses

ART 125 DRAWING I

Units: 3.0 [CSU, UC](#) | 32-36 hours lecture and 48-54 hours laboratory

(No prerequisite. Recommended preparation: ART 112)

This course is an introduction to principles and techniques in drawing. Students will gain a working knowledge of line, shape, perspective, proportion, volume, and composition. Students will learn how to look at, evaluate and present art work as well as be introduced to traditional and contemporary drawing with an emphasis on the development of observational skills and creative thinking.

ART 126 DRAWING II

Units: 3.0 [CSU, UC](#) | 32-36 hours lecture and 48-54 hours laboratory

(No prerequisite. Recommended preparation: ART 125.)

An intermediate drawing course emphasizing development of skills such as proportion, value, line, and space with an emphasis on personal expression, thematic development and the use of color. A variety of drawing media will be explored such as graphite, charcoal, color pencil, ink, pastel, and mixed media.

ART 128 SPECIAL TOPICS

See Special Topics listing (Variable units). [CSU,UC](#)

ART 129 INDEPENDENT STUDY

See Independent Study listing (1-3 units). [CSU](#)

ART 134 THE ART OF WEB DESIGN

Units: 4.0 [CSU](#) | 48-54 hours lecture and 48-54 hours laboratory

(No prerequisite)

An overview of industry standard software used for creating web pages. This course does not focus on HTML or scripting language but is focused on the development of effective communications design. See cross-listing for **CART 134**.

ART 135 INTRODUCTION TO TIME BASED ART/COMMUNICATION

Units: 4.0 [CSU](#) | 48-54 hours lecture and 48-54 hours laboratory

(No prerequisite)

This course covers the fundamental elements of creating and editing video using computer technology. Student will be taught how to use computer software to create dynamic visual content as it relates to artistic expression.

ART 138 COOPERATIVE EDUCATION

See Cooperative Education Listing (1-8 units). [CSU](#)

ART 141 SCULPTURE I

Units: 3.0 [CSU, UC](#) | 32-36 hours lecture and 48-54 hours laboratory

(No prerequisite. Recommended preparation: ART 101 or ART 102 and ART 105 and ART 106.)

This course is an introduction to the principles, theories, and techniques of sculptural objects, and the three-dimensional format. Students explore a variety of materials and processes, including additive and subtractive methods, assemblage and construction, and relief mold-making and casting. Concepts and trends in sculpture and three-dimensional art from pre-history to the contemporary will be studied. Students will develop an understanding of personal expression through form, and learn visual and verbal analysis pertaining to three-dimensional art.

Art and Design Courses

ART 150 OIL PAINTING I

Units: 3.0 *CSU, UC* | 32-36 hours lecture and 48-54 hours laboratory

(No prerequisite.)

This is an introductory course in oil painting. An emphasis in building a foundation in painting, techniques, process, color theory, visual perception, composition, and creative skills. Students will pay for their own supplies.

ART 151 INTERMEDIATE OIL PAINTING

Units: 3.0 *CSU, UC* | 32-36 hours lecture and 48-54 hours laboratory

(No prerequisite.)

There will be continuation of techniques covered in **ART 150** with an emphasis upon aesthetics, art history, critical analysis, and creativity. The student, through his own resourcefulness, is to formulate problems of compositional design, control of the medium and establish value judgments based upon fact that will be reflected in his works. Repetition of this course provides the opportunity for increased skill development.

Astronomy

Astronomy Courses

ASTR 101 DESCRIPTIVE ASTRONOMY

Units: 3.0 *CSU, UC* | 48-54 hours lecture

(No prerequisites)

A comprehensive study of astronomy. The historical development of astronomy, the structure of the solar system, modern techniques and instruments, the character of nebulae and galaxies, stellar character and theories, and the philosophical implications of astronomical discoveries.

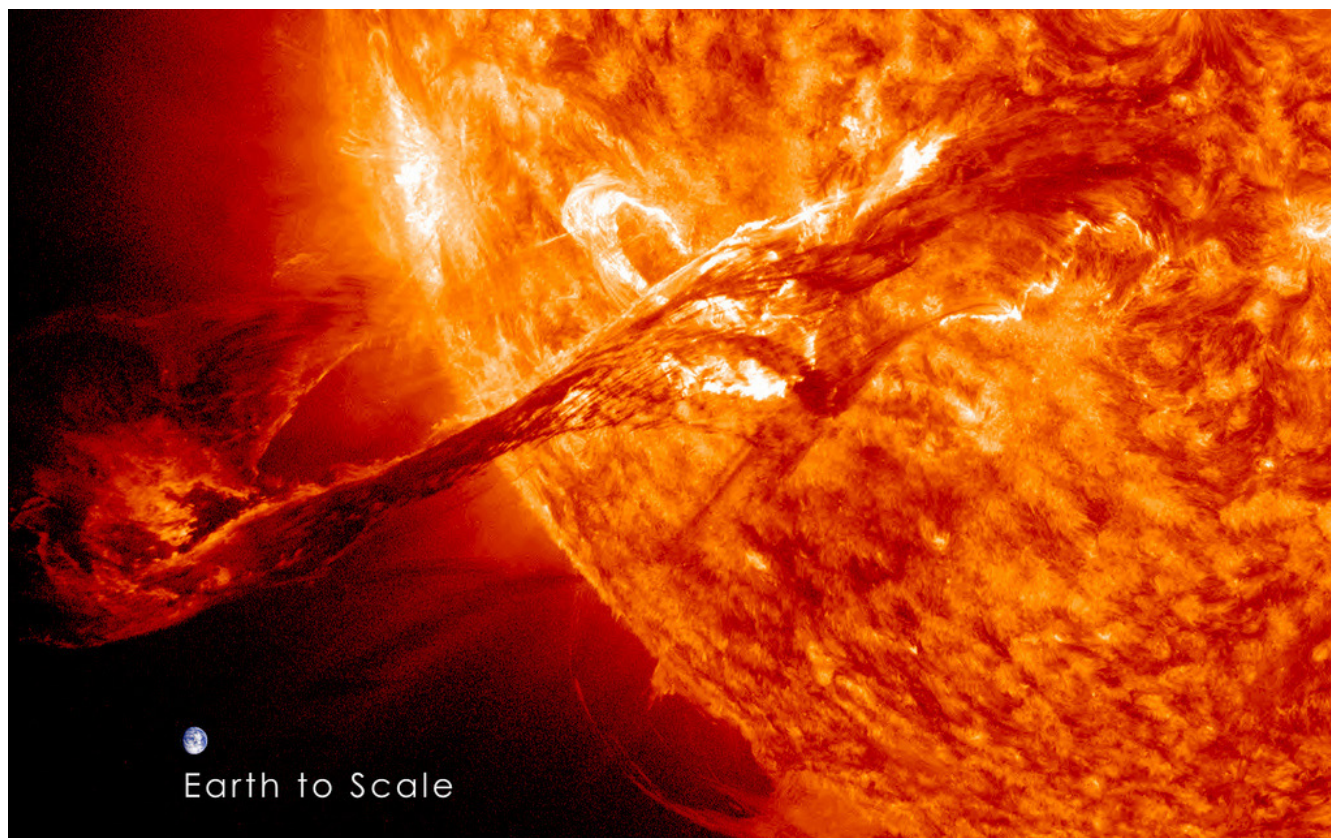

In keeping with the philosophy of providing programs to meet the diverse needs of students so that they may continue to develop physically, mentally, and emotionally throughout their lifetime, Victor Valley College supports and encourages students to participate in its athletic programs.

To meet this philosophic commitment, Victor Valley College athletic offerings include football, softball, men's and women's tennis, women's volleyball, men's and women's basketball, wrestling, golf, men's and women's soccer, men's and women's cross country, women's beach volleyball, men's and women's track and field, and baseball.

Victor Valley College is a member of the Foothill Athletic Conference and also competes with other community college conferences, California State and University junior varsity teams, private colleges, and service teams. A student must be enrolled in 12 units to participate in the intercollegiate athletic program. Student athletes are granted up to two years of eligibility per sport but must complete 24 units between seasons of competition with a "C" or better grade average in order to be eligible for the second year.

There are other factors that are essential in determining eligibility, and athletes should consult with the Eligibility Evaluator regarding eligibility matters. All varsity athletic classes meet 10 laboratory hours per week for 3 units. CSU, UC (UC credit limitation).

Men's And Women's Sports by Season	
FALL	SPRING
Basketball (M & W)	Baseball (M)
Cross Country (M & W)	Beach Volleyball (W)
Football (M)	Golf (M)
Soccer (M & W)	Softball (W)
Volleyball (W)	Tennis (M & W)
Wrestling (M)	

Athletics Courses

ATHL 120 VARSITY BASEBALL

Units: 3.0 **CSU, UC** | 144-162 hours laboratory

(UC maximum credit allowed: 4 units) (No prerequisite. ATHL 120P recommended) This course may be taken four times.

Students will learn the intermediate and advanced skills, rules, and strategies for competition in baseball.

ATHL 120P PREPARATION FOR INTERCOLLEGIATE MEN'S BASEBALL

Units: 0.5-1 **CSU** | 24-27 - 48-54 hours laboratory

(No prerequisite. Grade Option) This course may be taken four times.

This Men's Baseball course is designed to satisfy the interest, development and needs of the highly skilled student athlete. It will provide students with high level instruction and experience required for intercollegiate competition.

ATHL 121 VARSITY BASKETBALL (MEN)

Units: 1.5 **CSU, UC** | 72-81 hours laboratory

(UC maximum credit allowed: 4 units) (No prerequisite. ATHL 121P recommended) This course may be taken four times.

Students will learn the intermediate/advanced skills, rules, and strategies for competition in basketball.

ATHL121P PREPARATION FOR INTERCOLLEGIATE MEN'S BASKETBALL

Units: 0.5-1 **CSU** | 24-27 - 48-54 hours laboratory

(No prerequisite. Grade Option) This course may be taken four times.

This men's basketball course is designed to satisfy the interest, development and needs of the highly skilled student athlete. It will provide students with high level instruction and experience required for intercollegiate competition.

Athletics Courses

ATHL 122 VARSITY BASKETBALL (WOMEN)

Units: 1.5 **CSU, UC** | 72-81 hours

(UC maximum credit allowed: 4 units) (No prerequisite. ATHL 122P recommended). This course may be taken four times
Students will learn the intermediate/advanced skills, rules, and strategies for competition in basketball.

ATHL 122P PREPARATION FOR INTERCOLLEGIATE WOMEN'S BASKETBALL

Units Required: 0.5-1 **CSU** | 24-27 - 48-54 hours laboratory

(No prerequisite. Grade Option) This course may be taken four times.

This women's basketball course is designed to satisfy the interest, development and needs of the highly skilled student athlete. It will provide students with high level instruction and experience required for intercollegiate competition.

ATHL 123 CROSS COUNTRY (WOMEN)

Units: 3.0 **CSU, UC** | 144-162 hours laboratory

(UC maximum credit allowed: 4 units) (No prerequisite. ATHL 123P recommended) This course may be taken four times.

A cross country course designed to develop the knowledge, skills and strategy for the serious and recreational competitive athlete in collegiate long distance running. The course is designed to emphasize competition and will help the athlete achieve a higher level of competitive ability through instruction of skills, techniques, strategy and personal evaluation during or after competition. The students will be given an opportunity to compete at a wide range of competitive levels. CSU, UC.

ATHL 123P PREPARATION FOR INTERCOLLEGIATE WOMEN'S CROSS COUNTRY

Units: 0.5-1 **CSU** | 24-27 -48-54 hours laboratory

(No prerequisite. Grade option) This course may be taken four times.

This Women's Cross Country course is designed to satisfy the interest, development and needs of the highly skilled student athlete. It will provide students with high level instruction and experience required for intercollegiate competition. CSU

ATHL 124 VARSITY FOOTBALL

Units: 3.0 **CSU,UC** | 144-162 hours laboratory

(UC maximum credit allowed: 4 units) (No prerequisite. ATHL 124P recommended) This course may be taken four times.
Students will learn the intermediate/advanced skills, rules, and strategies for competition in football.

ATHL 124P PREPARATION FOR INTERCOLLEGIATE FOOTBALL

Units: 0.5-1 **CSU** | 24-27 - 48-54 hours laboratory

(No prerequisite. Grade Option) This course may be taken four times.

This Football course is designed to satisfy the interest, development and needs of the highly skilled student athlete. It will provide students with high level instruction and experience required for intercollegiate competition.

ATHL 125 VARSITY GOLF (MEN)

Units: 3.0 **CSU, UC** | 144-162 hours laboratory

UC maximum credit allowed: 4 units) (No prerequisite. ATHL 125P recommended) This course may be taken four times.
Students will learn the intermediate/advanced skills, rules, and strategies for competition in golf.

ATHL 125P PREPARATION FOR INTERCOLLEGIATE GOLF

Units: 0.5-1 **CSU** | 24-27 - 48-54 hours laboratory

(No prerequisite) This course may be taken four times.

This Golf course is designed to satisfy the interest, development and needs of the highly skilled student athlete. It will provide students with high level instruction and experience required for intercollegiate competition.

ATHL 126 VARSITY SOCCER (WOMEN)

Units: 3.0 **CSU, UC** | 144-162 hours laboratory

(UC maximum credit allowed: 4 units) (No prerequisite. ATHL 126P recommended) This course may be taken four times.
Students will learn the intermediate/advanced skills, rules, and strategies for competition in soccer.

ATHL 126P PREPARATION FOR INTERCOLLEGIATE WOMEN'S SOCCER

Units: 0.5-1 **CSU** | 24-27 - 48-54 hours laboratory

(No prerequisite. Grade Option) This course may be taken four times.

This Women's Soccer course is designed to satisfy the interest, development and needs of the highly skilled student athlete. It will provide students with high level instruction and experience required for intercollegiate competition.

ATHL 127 VARSITY SOFTBALL

Units: 3.0 **CSU, UC** | 144-162 hours laboratory

(UC maximum credit allowed: 4 units) (No prerequisite. ATHL 127P recommended) This course may be taken four times.
Students will learn the intermediate/advanced skills, rules, and strategies for competition in softball.

ATHL 127P PREPARATION FOR INTERCOLLEGIATE WOMEN'S SOFTBALL

Units: 0.5-1 **CSU** | 24-27 - 48-54 hours laboratory

CSU (No prerequisite. Grade Option) This course may be taken four times.

This Women's Softball course is designed to satisfy the interest, development and needs of the highly skilled student athlete. It will provide students with high level instruction and experience required for intercollegiate competition.

ATHL 128 VARSITY TENNIS (WOMEN)

Units: 3.0 **CSU, UC** | 144-162 hours laboratory

(UC maximum credit allowed: 4 units) (No prerequisite. ATHL 128P recommended) This course may be taken four times.
Students will learn the intermediate/advanced skills, rules, and strategies for competition in tennis.

ATHL 128P PREPARATION FOR INTERCOLLEGIATE WOMEN'S TENNIS

Units: 0.5-1 **CSU** | 24-27 - 48-54 hours laboratory

(No prerequisite. Grade Option) This course may be taken four times.

This Women's Tennis course is designed to satisfy the interest, development and needs of the highly skilled student athlete. It will provide students with high level instruction and experience required for intercollegiate competition.

ATHL 129 VARSITY TENNIS (MEN)

Units: 3.0 **CSU, UC** | 144-162 hours laboratory

(UC maximum credit allowed: 4 units) (No prerequisite. ATHL 129P recommended) This course may be taken four times.
Students will learn the intermediate/advanced skills, rules, and strategies for competition in tennis.

ATHL 129P PREPARATION FOR INTERCOLLEGIATE MEN'S TENNIS

Units: 0.5-1 **CSU** | 24-27 - 48-54 hours laboratory

(No prerequisite. Grade Option) This course may be taken four times.

This Men's Tennis course is designed to satisfy the interest, development and needs of the highly skilled student athlete. It will provide students with high level instruction and experience required for intercollegiate competition.

ATHL 130 VARSITY VOLLEYBALL

Units: 3.0 **CSU, UC** | 144-162 hours laboratory

(UC maximum credit allowed: 4 units) (No prerequisite. ATHL 130P recommended) This course may be taken four times.
Students will learn the intermediate/advanced skills, rules, and strategies for competition in volleyball.

Athletics Courses

ATHL 130P PREPARATION FOR INTERCOLLEGIATE VOLLEYBALL

Units: 0.5-1 **CSU** | 24-27 - 48-54 hours laboratory

(No prerequisite. Grade Option) This course may be taken four times.

This Volleyball course is designed to satisfy the interest, development and needs of the highly skilled student athlete. It will provide students with high level instruction and experience required for intercollegiate competition.

ATHL 132 VARSITY WRESTLING (MEN)

Units: 3.0 **CSU, UC** | 144-162 hours laboratory

(No prerequisite. Experience in high school or club level competition recommended.) This course may be taken four times.

A wrestling course designed to develop the knowledge, wrestling skills and strategy for the serious and recreational competitive athlete in collegiate, Greco-Roman and Freestyle wrestling. The course is designed to emphasize competition and will help the athlete achieve a higher level of competitive ability through instruction of skills, techniques, strategy, and personal evaluation during or after competition. The students will be given an opportunity to compete at a wide range of competitive levels.

ATHL 132P PREPARATION FOR INTERCOLLEGIATE WRESTLING

Units: 0.5-1 **CSU** | 24-27 - 48-54 hours laboratory

(No prerequisite. Grade Option) This course may be taken four times.

This Wrestling course is designed to satisfy the interest, development and needs of the highly skilled student athlete. It will provide students with high level instruction and experience required for intercollegiate competition

ATHL 133 MEN'S CROSS COUNTRY

Units: 3.0 **CSU, UC** | 144-162 hours laboratory

(UC maximum credit allowed: 4 units) (No prerequisite) This course may be taken four times.

A cross country course designed to develop the knowledge, skills and strategy for the serious and recreational competitive athlete in collegiate long distance running. The course is designed to emphasize competition and will help the athlete achieve a higher level of competitive ability through instruction of skills, techniques, strategy and personal evaluation during or after competition. Students will be given an opportunity to compete.

ATHL 133P PREPARATION FOR INTERCOLLEGIATE MEN'S CROSS COUNTRY

Units: 0.5-1 **CSU** | 24-27 - 48-54 hours laboratory

(No prerequisite. Grade Option) This course may be taken four times.

This Men's Cross Country course is designed to satisfy the interest, development and needs of the highly skilled student athlete. It will provide students with high level instruction and experience required for intercollegiate competition.

ATHL 140 VARSITY SOCCER (MEN)

Units: 3.0 **CSU, UC** | 144-162 hours laboratory

(UC maximum credit allowed: 4 units) (No prerequisite. ATHL 140P recommended) This course may be taken four times.

Students will demonstrate knowledge of rules, intermediate/advanced skills, and offensive and defensive strategies necessary to compete at collegiate level for soccer.

ATHL 140P PREPARATION FOR INTERCOLLEGIATE MEN'S SOCCER

Units: 0.5-1 **CSU** | 24-27 - 48-54 hours laboratory

(No prerequisite. Grade Option) This course may be taken four times.

This Men's Soccer course is designed to satisfy the interest, development and needs of the highly skilled student athlete. It will provide students with high level instruction and experience required for intercollegiate competition.

ATHL 143 SPORTS PERFORMANCE TRAINING

Units: 1.0 **CSU, UC** | 48-54 hours laboratory

(No prerequisite. Grade Option) This course may be taken four times

Sports performance training provides basic plyometric techniques which will allow students in athletics to dramatically increase their speed, strength, and stamina. Students will learn to use this training as preparation for athletic performance and winning mindsets.

ATHL 144 VARSITY SAND VOLLEYBALL WOMEN

Units: 3.0 **CSU** | 144-162 hours laboratory

(Recommended Prep: ATHL 144P.) This course may be taken three times.

Students will learn the intermediate to advanced skills, rules and strategies for competition in intercollegiate sand volleyball.

ATHL 144P PREPARATION FOR INTERCOLLEGIATE SAND VOLLEYBALL

Units: 1.0 **CSU** | 48-54 hours laboratory

(No prerequisite. Grade Option) This course may be taken four times

Sports performance training provides basic plyometric techniques which will allow students in athletics to dramatically increase their speed, strength, and stamina. Students will learn to use this training as preparation for athletic performance and winning mindsets.

Automotive Technology

It is the mission of the Automotive Department of Victor Valley Community College to provide quality automotive instruction to a diverse community of students; the array of courses offered shall serve the educational needs of the beginning student as well as the employed professional. Through industry input the department shall strive to create and maintain the most up to date curriculum based on current industry trends. The department will acquire and maintain the appropriate equipment that will augment the current course curriculum.

Each year the Bureau of Labor Statistics lists the need for Automotive Technicians as one of the nation's highest. This shortage of well-trained technicians has been created by the technological advances caused by the addition of the computerized engine controls and the need to control automotive pollution.

VVC's automotive program is designed to give the student a thorough and complete knowledge of the basics of the modern automobile. The program is capable of training the student to entry-level performance on the latest industry approved equipment.

Career Opportunities

Federally recognized ASE certification in eight (8) categories, Parts Salesperson, Repair Shop Owner or Operator State Certified Pollution Control Technician , Tune-up Technician

Faculty

Lee Bennett | Dan Rowland | Keith Shaner

Degrees and Certificates Awarded

Associate in Science, Automotive Technology	Automotive Brake and Suspension Specialist Certificate
Automotive Detailer/Porter Certificate	Automotive Drivability Specialist Certificate
Automotive Inspection and Maintenance Technician Certificate	Automotive Repair Shop Manager Certificate
Automotive Specialist I Certificate	Automotive Specialist II Certificate
Automotive Technician Certificate	Automotive Transmission Specialist Certificate

Program Learning Outcomes

A student receiving a degree or certificate in this field will be able to:

- Properly perform automotive repairs following industry standards for safety, comfort, and driveability.
- Safely and responsibly perform automotive repairs while minimizing negative impact on the environment.

Associate Degree

To earn an Associate in Science degree with a major in Automotive Technology (04946), complete a minimum of 18 units from any of the certificates or from any Automotive Technology courses and meet all Victor Valley College graduation requirements. AUTO 138 (Cooperative Education) may be used as Elective credit, but may not be used to fulfill major requirements.

Transfer

Not a transfer major.

Automotive Technology

AUTOMOTIVE BRAKE AND SUSPENSION SPECIALIST CERTIFICATE

Units Required: 8.0	<i>All of the following must be completed with a grade of "C" or better:</i>	
AUTO 60	Automotive Suspension and Alignment	4.0
AUTO 61	Automotive Brakes	4.0

AUTOMOTIVE DETAILER/PORTER CERTIFICATE

Units Required: 6.0	<i>All of the following must be completed with a grade of "C" or better:</i>	
<i>These classes should be taken in the following order.</i>		
AUTO 50	Introduction to Automotive Technology	4.0
AUTO 62	Automotive Detailing	2.0

AUTOMOTIVE DRIVEABILITY SPECIALIST CERTIFICATE

Units Required: 8.0	<i>All of the following must be completed with a grade of "C" or better:</i>	
<i>These classes should be taken in the following order.</i>		
AUTO 79B	Ignition and Fuel Systems	4.0
AUTO 80A	Automotive Computers, Electronics, and Electrical Systems	4.0

AUTOMOTIVE INSPECTION AND MAINTENANCE TECHNICIAN CERTIFICATE

Units Required: 6.0	<i>All of the following must be completed with a grade of "C" or better:</i>	
<i>These classes should be taken in the following order.</i>		
AUTO 79A	Basic Tune Up	2.0
AUTO 58	Automotive Lubrication Technician	2.0
AUTO 59	Automotive Tire Technician	2.0

AUTOMOTIVE REPAIR SHOP MANAGER CERTIFICATE

Units Required: 16.0	<i>All of the following must be completed with a grade of "C" or better:</i>	
<i>These classes should be taken in the following order.</i>		
AUTO 50	Introduction to Automotive Technology	4.0
AUTO 77.0	Automotive Service Writer and Shop Management or concurrently with AUTO 50	3.0
AUTO 77L	Automotive Service Writer and Shop Management Lab	2.0
AUTO 77.1	Automotive Leadership and Team Building	3.0
AUTO 77.2	Automotive Safety Training For Managers	3.0
BET 101	Beginning Keyboarding/Typing can be taken anytime during the program or BET 104A or B or C	1.0

AUTOMOTIVE SPECIALIST I CERTIFICATE (ENGINE REPAIR, DRIVE TRAIN, CHASSIS)

The certificate program in Engine Repair, Drive Train and Chassis will enable the student to obtain employment in any entry-level position in those related fields.

Units Required: 24.0	<i>All of the following must be completed with a grade of "C" or better:</i>	
<i>These classes should be taken in the following order.</i>		
AUTO 51	Automotive Engines and Drive Trains	12.0
AUTO 57	Automotive Brakes, Suspension and Wheel Alignment	12.0

Automotive Technology

AUTOMOTIVE SPECIALIST II CERTIFICATE

(ENGINE PERFORMANCE, ELECTRONICS [AUTO] POLLUTION CONTROL)

The certificate program in Engine Performance, Electronics [Auto], and Pollution Control will enable the student to obtain employment in any entry-level position in those related fields.

Units Required: 24.0

All of the following must be completed with a grade of "C" or better:

These classes should be taken in the following order.

AUTO 79	Tune-up, Pollution Control, and Fuel Systems	12.0
AUTO 80	Automotive Computers, Electronics, and Electrical Systems	12.0

AUTOMOTIVE TECHNICIAN CERTIFICATE

(ENGINE PERFORMANCE, ENGINE REPAIR, ELECTRONICS [AUTO], DRIVE TRAIN, POLLUTION CONTROL, CHASSIS)

This certificate is obtained upon successful completion of Automotive Specialist I and II and provides the student excellent entry-level skills in a wide range of automotive repair fields.

Units Required: 48.0

All of the following must be completed with a grade of "C" or better:

(Successful completion of Specialist I and II) These classes should be taken in the following order.

AUTO 51	Automotive Engines and Drive Trains	12.0
AUTO 57	Automotive Brakes, Suspension and Wheel Alignment	12.0
AUTO 79	Tune-up, Pollution Control, and Fuel Systems	12.0
AUTO 80	Automotive Computers, Electronics, and Electrical Systems	12.0

AUTOMOTIVE TRANSMISSION SPECIALIST CERTIFICATE

Units Required: 12.0

All of the following must be completed with a grade of "C" or better:

These classes should be taken in the following order.

AUTO 55	Standard Transmission Overhaul	5.0
AUTO 56A	Electronic Computer Transmission Controls	2.0
AUTO 56	Automatic Transmission Overhaul	5.0

SMOG INSPECTION TECHNICIAN CERTIFICATE

Units Required: 11.0

All of the following must be completed with a grade of "C" or better:

AUTO 85-D	Emission Diagnostic and Repair Training	3.0
AUTO 85.6	Emission Control Training	4.0
AUTO 85.5	Engine Emission Control Training	4.0

AUTO 50 INTRODUCTION TO AUTOMOTIVE TECHNOLOGY

Units: 4.0 | **48-54 hours lecture and 48-54 hours laboratory**

(No prerequisites)

This course provides the student with a basic knowledge of automotive systems and components. Information covered will serve as a foundation and prerequisite for advanced automotive classes. Topics covered will include safety, tool and shop equipment uses, industry practices, technician certification, theory and design of the major automotive systems.

AUTO 50.5 INTRODUCTION TO BASIC AUTOMOTIVE SERVICE AND MAINTENANCE

Units: 4.0 | **64-72 hours lecture**

(No prerequisite)

This course covers the basic functions of all the automotive systems as well as key parts of the entire automotive industry. Topics covered will include minor preventive maintenance procedures.

AUTO 51 AUTOMOTIVE ENGINES AND DRIVE TRAINS

Units: 12.0 | **128-144 hours lecture and 192-216 hours laboratory**

(No prerequisite)

This course covers techniques used by the Automotive Industry to diagnose and repair engine and drive train malfunctions, cylinder head, cylinder block, and drive train systems. Instruction will cover the diagnosis and repair of engine and drive train systems, cylinder heads, cylinder blocks, rotating assemblies, and basic drive train as they apply to the automobile.

AUTO 51A ENGINE REPAIR

Units: 4-6.0 | **48-54 hours lecture and 48-54 hours per unit of laboratory**

(No prerequisite)

This course provides the student with the knowledge necessary to diagnose and repair engines. Information covered will include diagnosis and repair of cylinder head and valve train, engine block, lubrication, cooling systems and general engine assembly.

AUTO 55.0 AUTOMOTIVE STANDARD TRANSMISSION AND DIFFERENTIAL OVERHAUL

Units: 4 - 5.0 | **48-54 hours lecture and 48-54 hours laboratory**

(Prerequisite: AUTO 50 with a grade of "C" or better.)

This course covers diagnosis and repair of the components of standard transmission systems, and differential systems, gears, synchronizers, bearings, clutches, and electronic controls. Standard trans-missions and related parts will be disassembled, inspected and determination made of the serviceability of existing parts. The need for replacement parts will be established as the components are disassembled, inspected and reassembled.

AUTO 56.0 AUTOMATIC TRANSMISSION OVERHAUL

Units: 4 - 5.0 | **48-54 hours lecture and 48-54 hours laboratory**

(Prerequisite: AUTO 50 with a grade of "C" or better.)

This course covers diagnosis and repair of the components of automatic transmission systems: clutches, bands, servo valve bodies, hydraulic pumps, cases, governors, torque converters, and electronic controls. Automatic transmissions and related parts will be disassembled, inspected and determination made of the serviceability of existing parts. The need for replacement parts will be established as the components are disassembled, inspected and reassembled.

AUTO 56A TRANSMISSION COMPUTER SYSTEMS

Units: 2.0 | **24-27 hours of lecture and 24-27 hours laboratory.**

(No prerequisite)

This course covers techniques used by the automotive industry to diagnose and repair transmission computer systems. Instruction will cover the diagnosis and repair of runability problems relating to electronic malfunctions of the computer controlled transmission.

Automotive Courses

AUTO 57.0 AUTOMOTIVE BRAKES, SUSPENSION, AND WHEEL ALIGNMENT

Units: 12.0 | 128-144 hours lecture and 192-216 hours laboratory

(No prerequisite)

This course covers diagnosis and repair and maintenance of the brake and suspension systems; including drum and disc brakes, brake hydraulics, power assist units, front and rear suspension systems, shocks and struts, steering linkages and power steering systems. All aspects of alignments will be covered including two and four wheel and struts on different alignment apparatuses. Maintenance of all parts of the brake and suspension systems will be covered.

AUTO 57.1 AUTOMOTIVE BRAKES, THEORY AND FUNCTION

Units: 3.0 | 48-54 hours lecture

(No prerequisite)

This course covers safety practices, theory, applications, braking systems, and antilock brakes.

AUTO 58 AUTOMOTIVE LUBRICATION TECHNICIAN

Units: 2.0 | 24-27 hours lecture and 24-27 hours laboratory

(No prerequisite)

This course covers techniques used by the Automotive Industry to perform routine preventative maintenance. Instruction will cover changing automotive fluids, lubrication, safety inspections, installing filters and ignition components.

AUTO 59.0 AUTOMOTIVE TIRE TECHNICIAN

Units: 2.0 | 24-27 hours lecture and 24-27 hours laboratory

(No prerequisite)

This course covers techniques used by the automotive industry to perform duties of a tire technician. Instruction will cover brake and suspension inspections, mounting, balancing, and repairing tires.

AUTO 60 AUTOMOTIVE SUSPENSION AND ALIGNMENT

Units: 4.0 | 48-54 hours lecture and 48-54 hours laboratory

(No prerequisite)

This course covers diagnosis and repair of the components of automotive suspension system. All related parts of the suspension and steering are inspected and determination of serviceability is made. Alignment of the front and rear of the vehicles will be covered, both manual and computer alignment.

AUTO 61.0 AUTOMOTIVE BRAKES

Units: 4.0 | 48-54 hours lecture and 48-54 hours laboratory

(No prerequisite. Recommended preparation: AUTO 57.0.)

This course covers diagnosis and repair of the components of automotive brake systems: basic hydraulics, drum brakes, disc brakes, turning drums and rotors, and related parts will be disassembled, inspected and determination made of the serviceability of existing parts. The need for replacement parts will be established as the components are disassembled inspected and reassembled.

AUTO 62 AUTOMOTIVE DETAILING

Units: 2.0 | 16-18 hours lecture and 48-54 hours laboratory

(No prerequisite)

This course provides students with the knowledge and skills necessary to correctly perform an automotive detail. Topics covered will include exterior paint polishing and treatment, interior and upholstery cleaning techniques, proper chemical and equipment usage, and dealership porter responsibilities.

AUTO 77 AUTOMOTIVE SERVICE WRITING AND SHOP MANAGEMENT

Units: 3.0 | **48-54 hours lecture**

(No prerequisite)

This course prepares students to manage an automotive repair shop. Topics covered include work order preparation, parts and labor estimating, parts ordering, office and shop organization, writing a legal work order, sales skills, and customer relations.

AUTO 77.1 AUTOMOTIVE LEADERSHIP AND TEAM BUILDING

Units: 3.0 | **48-54 hours lecture**

(No prerequisite)

This course provides the student with the knowledge necessary to successfully build a functional automotive team and be an effective automotive team leader. Topics covered will include automotive industry team development, recruitment and retention of team members. The course will also cover automotive industry motivation and compensation and the creation and maintenance of employee policies and procedures handbooks

AUTO 77.2 AUTOMOTIVE SAFETY TRAINING FOR MANAGERS

Units: 3.0 | **48-54 hours lecture**

(No prerequisite)

This course provides the student with the knowledge necessary to initiate and maintain an effective automotive safety training program in an automotive repair facility. Topics covered will include employee "Right to Know" laws and training requirements, safety audits and facility assessment, hazardous communications guidelines, personal protective equipment, and material handling and storage.

AUTO 77.3 AUTOMOTIVE WORKPLACE PROFESSIONALISM

Units: 2.0 | **32-36 hours lecture**

(No prerequisite)

This course presents information for working professionals in the automotive industry. Topics covered will include etiquette, dress, ethics, diversity, accountability, organization, communication and conflict resolution as they apply to the automotive industry.

AUTO 77L AUTOMOTIVE SERVICE WRITING AND SHOP MANAGER LABORATORY

Units: 2.0 | **96-108 hours laboratory**

(No prerequisite)

This course prepares students to effectively write automotive service orders and manage an automotive repair shop. Topics covered include labor guide look up and labor calculation, work order preparation, parts and labor estimating, parts ordering, office and shop organization, writing a legal work order, sales skills, and customer relations.

AUTO 79.0 AUTOMOTIVE TUNE-UP, EMISSION CONTROL, AND FUEL SYSTEM

Units: 12.0 | **128-144 hours lecture and 192-216 hours laboratory**

(Prerequisite: AUTO 50 with a grade of "C" or better.)

This course covers techniques used by the automotive industry to diagnose and repair ignition systems, fuel systems, and emission control systems. Instruction will cover the diagnosis and repair of conventional and electronic ignition systems, conventional and feedback carburetors, fuel injection, and emission control devices.

AUTO 79A BASIC TUNE-UP

Units: 2.0 | **24-27 hours lecture and 24-27 hours laboratory**

(No prerequisite)

This course covers techniques used by the Automotive Industry to diagnose and repair fuel and ignition systems. Topics will cover the diagnosis and repair of conventional and electronic ignition systems, fuel systems, and introduction to automotive computers.

Automotive Courses

AUTO 79B TROUBLE SHOOTING AND REPAIR OF IGNITION AND FUEL SYSTEMS

Units: 4.0

48-54 hours lecture and 48-54 hours laboratory

(No prerequisite)

This course covers techniques used by the automotive industry to diagnose and repair ignition systems and fuel systems. Topics covered included the diagnosis and repair of conventional and electronic ignition systems, conventional and feedback carburetors, along with emission control devices.

AUTO 80.0 AUTOMOTIVE COMPUTERS, ELECTRONICS AND ELECTRICAL SYSTEMS

Units: 12.0

128-144 hours lecture and 192-216 hours laboratory

(Prerequisite: AUTO 50 with a grade of "C" or better.)

This course covers techniques used by the automotive industry to diagnose and repair electrical malfunctions, computer, fuel injection, and electronic ignition systems. Instruction will cover the diagnosis and repair of electronic ignition systems, alternators, starters, computers, and basic electrical and electronic concepts as they apply to the automobile.

AUTO 80.6 INTRODUCTION TO AUTOMOTIVE ELECTRICITY

Units: 4.0

64-72 hours lecture

(No prerequisite)

This course covers electrical theory, basic electricity, electrical safety procedures, electrical diagnostic equipment, and industry approved procedures to diagnose and repair electrical malfunctions in the automobile.

AUTO 80A AUTOMOTIVE COMPUTERS, ELECTRONICS, AND ELECTRICAL SYSTEMS

Units: 4.0

48-54 hours lecture and 48-54 hours laboratory

(No prerequisite)

This course covers techniques used by the automotive industry to diagnose and repair computer and fuel injection systems. Topics covered include the diagnosis and repair of electronic ignition systems, alternators and starters. Basic electrical and electronic concepts as they apply to the automobile.

AUTO 80F FORD DIAGNOSTIC AND REPAIR STRATEGIES

Units: 4.0

48-54 hours lecture and 48-54 hours laboratory

(No prerequisite)

This course covers late-model Ford vehicles. Current factory procedures will be introduced to diagnose and repair OBD-2 computer and emission systems.

AUTO 82.0 AUTOMOTIVE ELECTRICAL REPAIR

Units: 4.0

48-54 hours lecture and 48-54 hours laboratory

(No prerequisite)

This course provides the student with the knowledge necessary to diagnose and repair automotive malfunctions including lighting systems, electrical instruments and accessories, electrical door components, air bags, and alarm systems. Information covered will include electrical fundamentals, test equipment, electrical circuits, electrical malfunctions, wiring diagrams, and electrical diagnosis.

AUTO 85.1 INTRODUCTION TO ENGINE PERFORMANCE THEORY

Units: 4.0

64-72 hours lecture

(No prerequisite)

This course covers engine performance theory and techniques used by the automotive industry to diagnose and repair drive-ability malfunctions.

AUTO 85.5 ENGINE AND EMISSION CONTROL TRAINING

Units: 4.0

48-54 hours lecture and 48-54 hours laboratory

(No prerequisite)

Engine and Emission Control Training is intended to provide students with fundamental knowledge of engine and emission control theory, design and operation. This course satisfies the Bureau of Automotive Repair (BAR) requirements for level one training.

AUTO 85.6 EMISSION CONTROL TRAINING

Units: 4.0 | 48-54 hours lecture and 48-54 hours laboratory

(No prerequisite)

Emission Control Training is intended to provide students with knowledge of emission control theory, design and operation. This course satisfies the Bureau of Automotive Repair (BAR) requirements for level two training

AUTO 85D BAR SPECIFIED DIAGNOSTIC AND REPAIR TRAINING

Units: 4.0 | 48-54 hours lecture. and 48-54 hours laboratory

(No prerequisite)

This course covers information required by the Bureau of Automotive Repair pertaining to diagnosis and repair of emission systems. Topics covered are: safety, electrical, emissions and diagnostic strategies.

AUTO 89.1 INTRODUCTION TO HYBRID VEHICLE TECHNOLOGY

Units: 4.0 | 48-54 hours lecture and 48-54 hours laboratory

(No prerequisite)

This course introduces hybrid vehicle technology. Topics covered will include electrical basics, batteries, types of hybrid vehicles, and preventive maintenance procedures.

AUTO 89.2 HYBRID VEHICLE MAINTENANCE AND SERVICE

Units: 4.0 | 48-54 hours lecture and 48-54 hours laboratory

(No prerequisite)

This course addresses hybrid vehicle maintenance and service procedures. Topics covered will include safety, manufacture specific hybrids, diagnostic and repair procedures as they relate to hybrid vehicles.

AUTO 95A AUTOMOTIVE LABORATORY

Units: 1.0 | 48-54 hours lecture and 48-54 hours laboratory

(No prerequisite)

A laboratory class to develop skills in engine repair, tune up, emissions, electrical, suspension, brakes, and general maintenance procedures.

AUTO 95B AUTOMOTIVE LABORATORY

Units: 2.0 | 96-108 hours laboratory

(No prerequisite)

This laboratory course covers the skills needed by the automotive industry to diagnose and repair ignition, emission and fuel systems.

AUTO 96.0 APPLIED TECHNICAL MATHEMATICS AND MEASURING INSTRUMENTATION

Units: 3.0 | 48-54 hours lecture

(No prerequisite)

This course provides trades people with applied foundation math skills necessary to perform required shop tasks. This course includes a review of basic mathematic operations, U.S. and Metric weights and measure, area and volume, fractions and decimals as applied to functional applications. Also discussed will be the theory, application and usage of precision measuring devices.

Automotive Courses

AUTO 97.0 AUTOMOTIVE AIR CONDITIONING AND HEATING SYSTEMS

Units: 4.0

48-54 hours lecture and 48-54 hours laboratory

(No prerequisite)

This course covers diagnosis and repair of the components of the automotive air conditioning and heating systems; evaporators, compressors, control valves, condensers, blowers, heater cores, lines and hoses, mechanical and electronic temperature controls. Air conditioning and heating related parts will be disassembled, inspected and determination made of the serviceability of existing parts. The need for re-placement parts will be established as the components are reassembled. Recovery and charging of different systems will be covered from both R-12 and R-134A systems.

AUTO 99.1 LIGHT DUTY DIESEL SYSTEMS 1

Units: 4.0

48-54 hours lecture and 48-54 hours laboratory

(No prerequisite)

This course covers the theory, design, diagnosis and repair of the light duty diesel power plant systems. Topics covered will include the fuel and emission systems.

AUTO 99.2 LIGHT DUTY DIESEL SYSTEMS 2

Units: 4.0

48-54 hours lecture and 48-54 hours laboratory

(No prerequisite)

This course covers the theory, design, diagnosis and repair of the light duty diesel power plant systems. Topics covered will include charging and starting systems, engine electronics, service and maintenance.

AUTO 99.3 LIGHT DUTY DIESEL SYSTEMS 3

Units: 4.0

48-54 hours lecture and 48-54 hours laboratory

(No prerequisite)

This course covers the theory, design, diagnosis and repair of the light duty diesel power plant systems. Topics covered will include intake and exhaust systems, cooling and lubrication circuits and forced air induction.

AUTO 99.4 LIGHT DUTY DIESEL SYSTEMS 4

Units: 4.0

48-54 hours lecture and 48-54 hours laboratory

(No prerequisite)

This course covers the theory, design, diagnosis and repair of the light duty diesel power plant systems. Topics covered will include cylinder block assemblies and cooling and lubrication circuits.

AUTO 138 COOPERATIVE EDUCATION

See Cooperative Education listing (1-8 units). [CSU](#)

Aviation Maintenance Technology training is offered locally at Southern California Logistics Airport (SCLA). This program includes all classroom and practical training required to prepare for the Federal Aviation Administration (FAA) licensing exams for Airframe and Power Plant Technicians. The program includes the following:

- General Aviation;
- Aviation – Power plant; and
- Aviation – Airframe

For more information about this program including registration for the next class session, go to www.vvc.edu and select Departments, Aviation Maintenance Technology.

Faculty

Christopher Ohshita

Degrees and Certificates Awarded

Associate in Science, Aviation Maintenance Technology
Aviation Powerplant Technician Certificate

Aviation Airframe Technician Certificate

Program Learning Outcomes

A student receiving a degree or certificate in this field will be able to:

- Safely and responsibly perform aviation repairs while minimizing impact on the environment
- Determine necessary repairs to bring the aircraft into industry compliance for general maintenance.

Associate Degree

To earn an Associate in Science degree with a major in Aviation Technology, complete the eight aviation courses focusing in generals, powerplant, and airframe Technology courses and meet all Victor Valley College graduation requirements.

AVIATION MAINTENANCE TECHNOLOGY, AS (35439)		
To earn an Associate in Science degree with a major in Aviation Maintenance Technology, complete the eight aviation courses focusing in general, powerplant, and airframe aviation Technology courses and meet all Victor Valley College graduation requirements.		
Program Requirements: 79.0 units		
<i>All of the following must be completed</i>		
AVA 51	General Aviation 1	9.5
AVA 52	General Aviation 2	9.5
AVA 61	Airframe 1	9.5
AVA 62	Airframe 2	9.5
AVA 63	Airframe 3	9.5
AVA 71	Powerplant 1	10.5
AVA 72	Powerplant 2	10.5
AVA 73	Powerplant 3	10.5
AVIATION AIRFRAME TECHNICIAN CERTIFICATE OF ACHIEVEMENT (17586)		
To earn an Associate in Science degree with a major in Aviation Maintenance Technology, complete the eight aviation courses focusing in general, powerplant, and airframe aviation Technology courses and meet all Victor Valley College graduation requirements.		
Program Requirements: 28.5 units <i>All of the following must be completed with a grade "C" or better:</i>		
AVA 61	Airframe 1	9.5
AVA 62	Airframe 2	9.5
AVA 63	Airframe 3	9.5

Aviation

AVIATION POWERPLANT TECHNICIAN CERTIFICATE OF ACHIEVEMENT (17587)

To earn an Associate in Science degree with a major in Aviation Maintenance Technology, complete the eight aviation courses focusing in general, powerplant, and airframe aviation Technology courses and meet all Victor Valley College graduation requirements.

Program Requirements: 31.5 units | *All of the following must be completed with a grade "C" or better:*

AVA 71	Powerplant 1	10.5
AVA 72	Powerplant 2	10.5
AVA 73	Powerplant 3	10.5

Aviation Courses

AVA 50 AVIATION TECHNOLOGY SURVEY

Units: 4.0 | **48-54 hours lecture and 48-54 hours laboratory**

(No prerequisites)

This course is designed to allow interested students the ability to explore aviation maintenance career pathways. This course will focus on principles and practices of modern aircraft maintenance technology.

AVA 51 GENERAL AVIATION 1

Units: 9.5 | **120-135 hours lecture and 96-108 hours laboratory**

(No prerequisites)

This course is designed to prepare students for a career in aviation maintenance technology. Topics include math, basic electricity, basic physics, fluid lines and fittings and materials and processes.

AVA 52 GENERAL AVIATION 2

Units: 9.5 | **120-135 hours lecture and 96-108 hours laboratory**

(Prerequisite: AVA 51 with a grade of 'C' or better, or equivalent experience)

This course is designed to prepare students for a career in aviation maintenance technology. Topics include maintenance and ground operations.

AVA 61 AIRFRAME 1

Units: 9.5 | **96-108 hours lecture and 168-189 hours laboratory**

(Prerequisite: AVA 51 and AVA 52 with a grade of 'C' or better, or equivalent experience)

This course is designed to prepare students for a career in aviation maintenance technology. Topics include aircraft materials (wood, metal, nonmetallic), coverings and finishes, aircraft inspection, assembly and rigging and welding.

AVA 62 AIRFRAME 2

Units: 9.5 | **96-108 hours lecture and 168-189 hours laboratory**

(Prerequisite: AVA 51 and AVA 52 with a grade of 'C' or better, or equivalent experience)

This course is designed to prepare students for a career in aviation maintenance technology. Topics include aircraft atmosphere, communication, navigation, fuel, landing gear, hydraulic, and pneumatic power systems.

AVA 63 AIRFRAME 3

Units: 9.5 | **96-108 hours lecture and 168-189 hours laboratory**

(Prerequisite: AVA 51 and AVA 52 with a grade of 'C' or better, or equivalent experience)

This course is designed to prepare students for a career in aviation maintenance technology. Topics include aircraft electrical systems, positioning and warning systems, ice and rain control systems, and fire protection systems.

AVA 71 POWERPLANT 1

Units: 10.5 | **128-144 hours lecture and 120-135 hours laboratory**

(Prerequisite: AVA 51 and AVA 52 with a grade of 'C' or better, or equivalent experience)

This course is designed to prepare students for a career in aviation maintenance technology. Topics include reciprocating engines, turbine engines, and engine inspection.

AVA 72 POWERPLANT 2

Units: 10.5 | **128-144 hours lecture and 120-135 hours laboratory**

(Prerequisite: AVA 51 and AVA 52 with a grade of 'C' or better, or equivalent experience)

This course is designed to prepare students for a career in aviation maintenance technology. Topics include induction and engine airflow systems, engine exhaust and reverser systems, and propellers.

AVA 73 POWERPLANT 3

Units: 10.5 | **128-144 hours lecture and 120-135 hours laboratory**

(Prerequisite: AVA 51 and AVA 52 with a grade of 'C' or better, or equivalent experience)

This course is designed to prepare students for a career in aviation maintenance technology. Topics include engine instrument systems, engine electrical, ignition and starting systems, and engine fuel systems.

AVA 74 AVIATION TECHNOLOGY CAPSTONE

Units: 4.0 | **48-54 hours lecture and 48-54 hours laboratory**

(No prerequisite)

This course is designed to prepare students for FAA licensure testing. Topics include a review of general, airframe, and power plant curricula.

Basic Skills

The Basic Skills program consists of several English and Math courses designed to prepare students for English and Math and to allow more advanced students to review core English and Math skills.

The courses offer instruction in both lecture and lab formats, which allow students to receive direct instruction in a classroom setting while also practicing essential skills at their own pace.

To prepare for English 6, students should enroll in BSKL3, Essential Reading and Writing (4 units).

To prepare for Math, students should enroll in BSKL 9, Essential Mathematics (4 units).

Basic Skills Courses

BSKL 3 ESSENTIAL READING AND WRITING

Units: 4.0

48-54 hours lecture and 48-54 hours laboratory

(No prerequisite. Pass/No Pass) This course does not apply to the Associate Degree

The course focuses on essential reading and writing skills and prepares students to begin their academic or vocational college careers.

BSKL 9 ESSENTIAL MATHEMATICS

Units: 4.0

48-54 hours lecture and 48-54 hours laboratory

(No prerequisite. Pass/No Pass) This course does not apply to the Associate Degree

The course focuses on essential mathematical skills in arithmetic, fractions, decimals and word problems and prepares students to begin their college careers. Percentages, ratios, and proportions are also introduced.



Biological Science

The biological science courses are designed to meet a variety of student requirements. Some courses are designed to fulfill the laboratory general education requirement.

Biology and pre-professional majors will find rigorous, comprehensive classes. Other classes, including non-laboratory, are offered for non-majors and those with special interest areas.

Career Opportunities (May require advanced degree)

Environmental Analyst, Healthcare, Life Science Education, Forensic Science, Biological Research

Faculty

David Gibbs | Hinrich Kaiser | Jessica Gibbs | Lisa Harvey | Naveen Jalota

Degrees and Certificates Awarded

Associate in Arts, Liberal Arts (Math/Science)

Associate in Science, Math/Science

Program Learning Outcomes

A student receiving a degree or certificate in this field will be able to:

- Demonstrate a breadth of knowledge in biological concepts and principles.
- Communicate scientifically to peers and to the community.
- Apply the scientific method to discover the living world around us and recognize its value to human advancements in health and impact on the environment.

Associate Degree

No associate degree offered with a major in Biological Science. Biology courses may be used to fulfill requirements for an Associate in Science degree with a major Math/Science or Liberal Arts with emphasis in Math/Science. See Math/Science or Liberal Arts for degree requirements for these majors. BIOL 138 (Cooperative Education) may be used as Elective credit but may not be used to fulfill major requirements.

Transfer

For the most up-to-date information on these programs and others, visit www.assist.org. Please stop by the Transfer Center in Building 55 or make an appointment with a counselor if you have questions.

- **California State University, San Bernardino:** Biology major
- **University of California, Riverside :** Biology major

Biological Science Courses

BIOL 98 A/B COMPARATIVE NATURAL HISTORY STUDIES

Units: 3-4.0

16-18 lecture hours plus 96-108 hours laboratory for each unit

(No prerequisite. Grade Option)

This course offers students the opportunity to learn first-hand about plants, animals, ecology, geography, and conservation policies of the trip destination, which is most frequently a foreign country. Pre-trip lectures will include slide shows of organisms you may see and previews of activities and adventures you will experience on the natural history field trip. Trips vary in length from 9 days to 2.5 weeks. Biology majors who wish to participate in a CSU transferable course with more rigorous course requirements and comprehensive biodiversity studies may wish to enroll in **BIOL 250A**, Ecosystem Field Biology which is offered concurrently.

BIOL 100 GENERAL BIOLOGY

Units: 4.0

CSU, UC

48-54 hours lecture and 48-54 hours laboratory

(UC credit limitation) (No prerequisite)

This is an introductory course with emphasis on the scientific method, analysis of scientific data, metric system, current biological problems, cellular biology, genetics and heredity, classification and systematics, evolution, ecology, behavior and environmental issues. The laboratory will include a survey of the morphological characteristics of various organisms on this planet.

Biological Science Courses

BIOL 107 INTRODUCTION TO HUMAN BIOLOGY

Units: 4.0 **CSU** | 48-54 hours lecture and 48-54 hours laboratory

(No prerequisite)

An introduction to biological principles with a human perspective. Emphasis on cellular structure and function, organ systems, the concept of homeostasis, adaptation, cellular and population genetics, and the interaction of the human species with the ecosystem.

BIOL 110 INTRODUCTION TO HUMAN NUTRITION

Units: 3.0 **CSU** | 48-54 hours lecture

(Prerequisite: BIOL 231, and CHEM 100, CHEM 100H or CHEM 206. Recommended Preparation: ENGL 101.0 or ENGL H101.0)

Introduction to the medical aspects of nutrition, intended for students pursuing a career in health care. Biological function and chemical classification of nutrients. Nutritional needs throughout the lifespan. Effects of nutritional deficiencies and excesses. Recommended nutrient intakes and the role of diet in the development of chronic disease.

BIOL 118 PRINCIPLES OF HEREDITY

Units: 3.0 **CSU, UC** | 48-54 hours lecture

(No prerequisite)

A survey of Mendelian inheritance, quantitative traits, and population genetics with special emphasis on human inheritance and family pedigree analysis. Also includes sections on DNA technology, immune genetics and genetics of cancer. This course stresses development of critical thinking and problem solving skills.

BIOL 138 COOPERATIVE EDUCATION

See Cooperative Education listing (1-8 units). **CSU**

BIOL 145 FORENSIC PATHOLOGY

Units: 3.0 **CSU** | 48-54 hours lecture

(No prerequisite)

The scientific techniques used in forensic pathology investigations of regional injuries and death including firearm, transportation and physical injuries, trauma and disease, child abuse, sexual assaults, diagnosis of rape, pregnancy, abortion and delivery, infanticide, asphyxial and drug deaths. The course will cover forensic medical evidence and records for the court.

BIOL 149 INDEPENDENT STUDY

Units: 1-3.0 **CSU** | 54-162 hours lecture

See Independent Study listing (1-3 units).

BIOL 201 BIOLOGY OF CELLS

Units: 5.0 **CSU, UC** | 48-54 hours lecture and 96-108 hours laboratory

(Prerequisite: MATH 90 or higher with a grade "C" or better. Prerequisite or co-requisite: CHEM 100 or CHEM 201 with a minimum grade of 'C' or better.)

This course will provide students with a comprehensive introduction to the biological principles at the cellular and molecular level. Emphasis will be placed on the scientific method, molecular biology, biochemistry, structure and function of cells, cellular reproduction and Mendelian and molecular genetics. This course is designed for pre-professional and biology majors but is open to all students.

Biological Science Courses

BIOL 202 BIOLOGY OF ORGANISMS

Units: 5.0 **CSU, UC** | 48-54 hours lecture and 96-108 hours laboratory

(Prerequisite: MATH 90 or higher with a grade "C" or better).

This course provides students with a comprehensive introduction to the diversity of biological organisms. Emphasis is placed on the origin of life, evolutionary relationships among groups of organisms and the basic anatomy and physiology of the major groups of living organisms and an introduction to the principles of ecology. Biology majors should also take Biology 201.

BIOL 203 POPULATION AND ENVIRONMENTAL BIOLOGY

Units: 4.0 **CSU, UC** | 48-54 hours lecture and 48-54 hours laboratory

(Prerequisite: MATH 90 minimum grade C.)

This rigorous course is an introduction to the structure and organization of populations, communities and ecosystems. Emphasis will be on demography, population growth, life history traits, extinction, species interactions and behaviors, ecosystem dynamics and evolution, as well as selected current environmental issues. Mathematical modeling, a difficult yet important aspect of population and community ecology, will also be addressed. Students will participate in field laboratories, use statistics to analyze data and compose scientific papers. This course is designed for biological science majors, but is open to all students.

BIOL 210 BIOLOGY OF PLANTS

Units: 5.0 **CSU** | 48-54 hours lecture and 96-108 hours laboratory

(Prerequisite: BIOL 100 or BIOL H100, BIOL 201 with a grade of "C" or better.)

This rigorous course will provide students with a comprehensive introduction to botanical principles from the cellular and molecular level to the functions of plants in ecosystems. Emphasis will be placed on plant molecular biology, biochemistry, and physiology, especially photosynthesis (C3, C4, and CAM), cell respiration, and water relations. The structure and function of plant cells, plant anatomy, plant reproduction, plant growth and development, Mendelian and molecular genetics, and plant systematics and evolution will also be covered. This course is designed for pre-professional and biology majors, but is open to all students. The course will stress the use of the scientific method, critical thinking, and problem-solving skills. Up to two field trips may be required.

BIOL 211 HUMAN ANATOMY

Units: 5.0 **CSU, UC** | 48-54 hours lecture and 96-108 hours laboratory

(UC credit limitation). (Prerequisite: BIOL 100 or BIOL H100, BIOL 107, or BIOL 201 with a grade of "C" or better.)

An introduction to the gross and microscopic anatomy of the human body. Lab includes dissection of cat, sheep eye, kidney, heart, and larynx. Lab also includes demonstration on assorted anatomical models including demonstrations on human cadavers when available. Lecture covers cells, tissues, and the major human systems such as the integumentary, skeletal, muscular, nervous, endocrine, cardiovascular, respiratory, urinary, and reproductive.

BIOL 213 SEXUALLY TRANSMITTED DISEASES

Units: 3.0 **CSU** | 48-54 hours lecture

(No prerequisite)

This course will provide an understanding of the history and pathogenesis of the most prominent sexually transmitted diseases. Emphasis will be placed on the biological agent, epidemiology, diagnosis and treatment of the disease. Vaccine development and current treatments will also be examined.

BIOL 215 HUMAN GROSS ANATOMY

Units: 4.0 **CSU** | 48-54 hours lecture and 48-54 hours laboratory

(Prerequisite: BIOL 211 with a grade of "C" or better.)

An advanced anatomy class that utilizes a regional approach to the study of the thorax, abdomen, pelvis, back, extremities, head and neck. Lecture will include medical/clinical applications and case studies on these regions. Laboratory includes hands on group dissection on a whole cadaver; as well as work on a high-level anatomy software program.

Biological Science Courses

BIOL 221 GENERAL MICROBIOLOGY

Units: 5.0 **CSU, UC** | 48-54 hours lecture and 96-108 hours laboratory

(Prerequisites: BIOL 100 or BIOL 100H, 107 or 201; CHEM 100 or CHEM 100H, or CHEM 201; all completed with a grade of "C" or better.)

Introduction to bacteria, viruses, and parasitic forms of protozoa, helminths, and fungi. Examination of morphological, physiological, and epidemiological characteristics of these organisms and of the immune response produced by their hosts.

BIOL 231 HUMAN PHYSIOLOGY

Units: 5.0 **CSU, UC** | 48-54 hours lecture and 96-108 hours laboratory

(Prerequisites: BIOL 100, or BIOL 107, or BIOL 201; and BIOL 211; CHEM 100 or CHEM 201; all completed with a grade of "C" or better.)

Study of the physiological principles, function, integration and homeostasis of the human body at the cellular, tissue, organ, organ system and organism level: integumentary system, bone, skeletal, smooth and cardiac muscles, nervous system, sensory organs, cardiovascular system, lymphatic and immune systems, respiratory system, urinary system, digestive system, endocrine system, and reproductive system. This course is primarily intended for Nursing, Allied Health, Kinesiology, and other health related majors.

BIOL 233 PATHOPHYSIOLOGY

Units: 3.0 **CSU** | 48-54 hours lecture and 96-108 hours laboratory

(Prerequisite: BIOL 231 with a grade of "C" or better.)

This course is designed to promote understanding and application of fundamental disease processes in clinical settings. General concepts of disease, including etiology, pathogenesis, morphology and clinical significance are discussed. General pathophysiology concepts include: cell injury, necrosis, inflammation, wound healing and neoplasia. These concepts are applied in a systems-oriented approach to disease processes affecting musculoskeletal, cardiopulmonary, renal, nervous, gastrointestinal, immune, hematological and endocrine systems.

BIOL 250A ECOSYSTEM FIELD BIOLOGY

Units: 3.0 **CSU** | 16-18 hours lecture and 96-108 hours laboratory

(Prerequisite: BIOL 100, BIOL 100H or equivalent. Grade Option)

This course lets students experience various ecosystems from a fieldwork and research perspective. Students will learn research techniques hands-on from basic specimen collecting, species identification, and data gathering in the field to data analysis and scientific writing and will apply these in biodiversity surveys of terrestrial or aquatic habitats or both. An emphasis will be placed on amphibians and reptiles, or plant life, or birds, or mammals, or a combination of these (depending on the specialty of the instructor) and adaptations to life in tropical or other ecosystems. Pre-trip lectures will include information about habitats and organisms of the destination country, as well as previews of activities and adventures you will experience on the field trip. Trips vary in length from 9 days to 2.5 weeks. This course is intended for biology majors but is open to all students. Non-majors who wish to participate with less rigorous course requirements may wish to enroll in BIOL 98, Comparative Natural History Studies, which is offered concurrently.

BIOL 295H UNDERGRADUATE RESEARCH I – SCIENTIFIC COMMUNICATION

Units: 3.0 **CSU** | 48-54 hours lecture

(Prerequisites: Prerequisite: BIOL 100, 100H, BIOL 107 or BIOL 201; minimum grade C.)

If the goal of science is to contribute to our understanding of the natural world, then the goal of scientific writing is to communicate that understanding with precision, accuracy, and economy. In this course, you will develop your skills as a writer of scientific research, skills that will contribute to your learning of course material and to creating your identity as a scientist. You will explore the genre of the research article and its components and develop an understanding of the material. In addition, you will develop your skills as a writer, reviser, and editor—working with your peers and your instructor—and, ultimately, develop a solid foundation for writing your future research work.

Biological Science Courses

BIOL 296H UNDERGRADUATE RESEARCH II – EXPERIMENTAL DESIGN

Units: 4.0

CSU

48-54 hours lecture and 48-54 hours laboratory

(Prerequisites: BIOL 100 or 100H, BIOL 107, BIOL 201, BIOL 202, BIOL 221 or BIOL 231; minimum grade C.)

This course allows students to select a research project, write a literature review and research proposal, conduct preliminary experiments, and write a research report. Research methods and experimental design will be emphasized, including the location and study of articles from the professional literature. Undergraduate research helps students develop valuable skills, and provides students with an opportunity to apply scientific knowledge in the context of “real world” problems. Participation will also open up opportunities for students to take part in analyzing data and conducting field research.

Business

Degrees and Certificates Awarded

Associate in Science, Business

Associate Degree

Students may earn an Associate in Science degree with a major in Business by completing a minimum of 18 units from any certificate offered in the departments of Business Administration, Business Education Technologies, and Business Real Estate and Escrow or from a blend of courses from any of the following.

The minimum 18 units for the Business major may come from any of the following:

ALDH 80, 81, 82, 139, **CIS** 101, **ECON** 101, 102, **MATH** 105, 120

Any Business Administration course except **BADM**138

Any Business Education Technology course except **BET** 138

Any Business Real Estate course except **BRE** 138

Students may wish to consider majoring in Business Administration, Business Education Technologies, or Business Real Estate and Escrow rather than general Business, in order to assure a stronger curriculum base.

Transfer

See *Business Administration* or *Business Education Technologies* for transfer requirements.

Business Administration

The Business Administration Department offers a variety of courses in business which allows a student to comply with the lower-division requirements for transfer to university level programs. Courses are also offered which allow the student to prepare for career entry-level positions and for upgrading of job skills for the already career-oriented student.

The department offers two certificates: a Management Certificate and Bookkeeping I Certificate. The Certificates are designed for those students interested in entering the field of business or for those who are currently working and would like to upgrade their business skills. Students completing the Management Certificate will have entry-level management knowledge and skills. Students completing the Bookkeeping I Certificate will have entry-level bookkeeping/accounting clerk skills. These certificates will also indicate that the student has completed a series of courses for skill upgrading for those already employed.

In addition to the certificates, students may also earn an Associate of Science degree in Business Administration. Many of the Business Administration Department courses are offered online via the Internet, allowing a student to earn the Management Certificate and/or the AS Degree through distance education. See the current schedule of classes for a listing of Online classes.

Those students planning to transfer to an upper-division institution should select their courses with the assistance of a counselor since each transfer institution has unique requirements.

Career Opportunities

Positions from entry-level to mid-management may be reasonable expectations upon completion of either the degree or the certificate programs in the fields of retailing, merchandising, service-related businesses, bookkeeping, and manufacturing firms. Some possible position titles include:

Accounting Clerk/Bookkeeper, Administrative Assistant, Department Manager, Human Resource Manager, Marketing Manager, Merchandise Buyer, Merchandise Manager, Office Manager, Purchasing Management, Salesperson, Store Manager

Faculty

Peter Allan - Emeritus | David Hollomon | O. Odell Moon | Henry Young

Degrees and Certificates Awarded

Associate in Science, Business Administration
Management Certificate

Bookkeeping I Certificate

Program Learning Outcomes

A student receiving a degree or certificate in this field will be able to:

- Effectively use various channels of communication.
- Successfully solve business related mathematical computations.
- Apply ethical principles (behavior) in a business environment.
- Demonstrate appropriate human relation skills in a work environment.
- Describe how the nature of management varies at different organizational levels.
- Demonstrate entry-level competence in recognizing and applying accounting principles and concepts to record and interpret business transactions.
- Perform financial and microcomputer accounting activities.

Associate Degree

To earn an Associate in Science degree with a major in Business Administration (10787), complete a minimum of 18 units from any of the certificate requirements or from any Business Administration courses and meet all Victor Valley College graduation requirements. **BADM 138** (Cooperative Education) may be used as Elective credit but may not be used to fulfill major requirements.

Business Administration

Transfer

For the most up-to-date information on these programs and others, visit www.assist.org. Please stop by the Transfer Center in Building 55 or make an appointment with a counselor if you have questions.

- **California State University, San Bernardino:** Administration major

Complete the following courses prior to transfer if possible: BADM 101 or 103; 102 or 104; 118; ECON 101, 102; CIS 101; MATH 105, 120. Additional classes may be required in some concentrations.

- **University of California, Riverside:** Business Administration major

Complete the following courses prior to transfer if possible: BADM 100; 101 or 103; CIS 101; ECON 101, 102; Math 120, 226.

Local Bachelors Programs

For information on the following programs located in the High Desert, please visit: www.vvc.edu/offices/transfer-center and select "Counseling Information Sheets":

- **Azusa Pacific University, High Desert Regional Center:**
Organizational Leadership major.
- **Brandman University, Victor Valley Campus:**
Business Administration major, Organizational Leadership major.
- **University of La Verne, High Desert Campus**
Business Administration major, Organizational Management major, Public Administration major.

BOOKKEEPING I CERTIFICATE OF CAREER PREPARATION

The Bookkeeping I Certificate is designed to give the student entry-level skills as an accounting clerk or bookkeeper. These skills include the ability to sort, record, and file accounting data, as well as perform general accounting tasks and assist in the processes of summarizing and analyzing accounting information, both manually and using a computerized accounting program.

Units Required: 16.0 | *All of the following must be completed:*

BADM 106	Accounting Software Applications Part A	2.0
BADM 107	Accounting Software Applications Part B	2.0
BADM 100	Introduction to Business Organization	3.0
BADM 142	Business Mathematics	3.0
BADM 50	Applied Accounting I	3.0
BADM 51	Applied Accounting II	3.0

MANAGEMENT CERTIFICATE OF ACHIEVEMENT (04941)

The Management Certificate will give the student basic skills and education to become an entry-level manager in retailing, merchandising, service-related businesses, and manufacturing firms.

Note: English 101 is strongly recommended for success in the required classes.

Units Required: 31.0 | *All of the following must be completed:*

Group I - All of the following must be completed:

BADM 101	Financial Accounting (or BADM 103 Financial Accounting Fundamentals)	4.0
BADM 110	Principles of Management	3.0
BADM 117	Legal Environment of Business	3.0
BADM 100	Introduction to Business Organizations	3.0
BADM 142	Business Mathematics	3.0
BADM 144	Business Communications	3.0
CIS 101	Computer Literacy	4.0

Group II - One of the following must be completed:

BADM 112	Introduction to Marketing	3.0
BADM 122	Small Business Management	3.0

*Group III - One of the following must be completed: **Note:** Math 90 is a prerequisite*

ECON 101	Principles of Economics : Macro	3.0
ECON 102	Principles of Economics : Micro	3.0

Group IV - One of the following must be completed:

BADM 109	Human Resource Management	3.0
BADM 116	Human Relations in Business	3.0
BADM 52	Elements of Supervision	3.0

Business Administration Courses

BADM 50 APPLIED ACCOUNTING I

Units: 3.0 | 48-54 hours lecture

(No prerequisites)

Introduction to the bookkeeping problems of a small business enterprise for both merchandising and service-type organization. Emphasis on the development of skills for both cash and accrual methods of recording, including procedures for completion of an accounting cycle. Attention is given to special journals, subsidiary ledgers, and payroll and control systems.

BADM 51 APPLIED ACCOUNTING II

Units: 3.0 | 48-54 hours lecture

(No prerequisites)

Continuation of bookkeeping procedures with special emphasis on the development of skills in the valuation of assets, business taxes, accruals and deferrals, preparation of financial statements, and payroll tax analysis.

BADM 52 ELEMENTS OF SUPERVISION

Units: 3.0 | 48-54 hours lecture

(No prerequisites)

This course is designed to introduce the student to the concepts of effectively supervising employees. Students will be introduced to the elements of directing the work of others and the specific skills required for goal setting, budgeting, scheduling, delegating, interviewing, negotiation, handling grievances, counseling employees, and performance evaluations.

BADM 100 INTRODUCTION TO BUSINESS ORGANIZATIONS

Units: 3.0 | *CSU, UC* 48-54 hours lecture

(No prerequisites)

A survey course designed to introduce the student to contemporary issues and principles of business, as well as the different business disciplines a student may be interested in pursuing as a career. These areas include management, marketing, accounting, finance, human resource management, and entrepreneurship. In addition, other topics include the global dimension of business, the various forms of business ownership, teamwork, securities, ethics and social responsibility, and economic challenges facing the 21st century. 48-54 hours lecture.

BADM 101 FINANCIAL ACCOUNTING

Units: 4.0 | *CSU, UC* 64-72 hours lecture

(No prerequisite) (UC credit limitation).

This introductory financial accounting course provides instruction in the theory and practice of accounting applicable to recording, summarizing, and reporting of business transactions for external uses. Topics include coverage of asset valuation, revenue and expense recognition, and appropriate accounting methods for long term assets, liability, and capital accounts. Additional areas of coverage include financial statement and rational analysis. The course includes application of general ledger software as well as Microsoft Excel programs. This course is required for business majors preparing for and planning to transfer to a four year college or university.

BADM 102 MANAGERIAL ACCOUNTING

Units: 4.0 | *CSU, UC* 64-72 hours lecture

(UC credit limitation). (No prerequisite)

This course is the study of theory and practices of managerial accounting and organizational quantitative analysis with decision making. Special emphasis is placed on product and process costing, responsibility accounting, break even analysis and master budgeting.

BADM 103 FINANCIAL ACCOUNTING FUNDAMENTALS

Units: 3.0 | *CSU, UC* 48-54 hours lecture

(UC credit limitation). (No prerequisite)

This course is the study of accounting as an information system, examining why it is important and how it is used by investors, creditors, and others to make decisions. The course covers the accounting information system, including recording and reporting of business transactions with a focus on the accounting cycle, the application of generally accepted accounting principles, the financial statements, and statement analysis. Includes issues relating to asset, liability, and equity valuation, revenue and expense recognition, cash flow, internal controls, and ethics.

Business Administration Courses

BADM 104 PRINCIPLES OF ACCOUNTING

Units: 3.0 **CSU, UC** | 48-54 hours lecture

(UC credit limitation). (No prerequisite)

This is the study of how managers use accounting information in decision-making, planning, directing and controlling operations. Focuses on cost terms and concepts, cost behavior, cost structure and cost-volume-profit analysis. Includes issues related to absorption and activity based costing systems. Additional coverage on performance analysis of manufacturing and service organizations.

BADM 106 ACCOUNTING SOFTWARE APPLICATIONS PART A

Units: 2.0 **CSU** | 24-27 hours lecture and 24-27 hours laboratory

(No prerequisite)

Students will learn the concepts of applying accounting software designed for small businesses. This includes entering data, processing data, creating and interpreting financial reports / statements.

BADM 107 ACCOUNTING SOFTWARE APPLICATIONS PART B

Units: 2.0 **CSU** | 24-27 hours lecture and 24-27 hours laboratory

(No prerequisite)

This course is intended to be a continuation and expansion on accounting procedures covered in BADM 106. Topics covered include setting up a business accounting system including customers, vendors, and accounts, payroll, cash and accrual systems, inventory control, banking, budgeting, taxation, financing and investing. Students will be using small business accounting software.

BADM 109 HUMAN RESOURCE MANAGEMENT

Units: 3.0 **CSU** | 48-54 hours lecture

(No prerequisite)

This introductory course is designed to acquaint the student with the important functions performed by the human resource department in a business organization. These functions include recruiting, staffing, training and development, compensation, strategic human resource planning, personnel evaluation, and management-labor relations. Other topics include global issues, the legal environment, EEO, sexual harassment, and design of work. This course is for the managerial candidate, for those who have not had formal management training, or for the individual who is currently or interested in working in a human resource department.

BADM 110 PRINCIPLES OF MANAGEMENT

Units: 3.0 **CSU** | 48-54 hours lecture

(No prerequisite)

This is an introductory course to the management functions of planning, organizing, leading and controlling. The concepts of corporate culture, the impact of the external environment, business ethics and social responsibility, motivation, communication and teamwork, globalization, and quality control are a few of the topics covered. This course is designed for the managerial candidate or for the individual who has worked but not had formal training in business management.

BADM 112 INTRODUCTION TO MARKETING

Units: 3.0 **CSU** | 48-54 hours lecture

(No prerequisite)

This course is an introduction to contemporary marketing principles. Included in this course will be relationship marketing, the global dimension of marketing, e-commerce, marketing plan development, research, market segmentation, product strategy, distribution, promotional, and pricing strategies.

Business Administration Courses

BADM 116 HUMAN RELATIONS IN BUSINESS

Units: 3.0 [CSU](#) | 48-54 hours lecture

(No prerequisite)

Human relation skills mean interactions among people and represent the single biggest reason for career success and failure. This course provides a clear understanding of human relation concepts, the application of human relation concepts for critical thinking in the business world, and the ability to increase the student's development of human relation skills.

BADM 117 LEGAL ENVIRONMENT OF BUSINESS

Units: 3.0 [CSU, UC](#) | 48-54 hours lecture

(UC credit limitation) (No prerequisite)

The study of the American legal system and principles of law as applies to business. Course content includes the legal environment of business, nature and source of law, court systems, dispute resolution, common and statutory law, Constitutional law, administrative agencies, torts and business torts, contract law, and the Uniform Commercial Code as it relates to the sale of goods. Additionally, the legal forms of business will be addressed as to the formation, operation, and termination of proprietorships, partnerships, and corporations.

BADM 118 BUSINESS LAW

Units: 3.0 [CSU, UC](#) | 48-54 hours lecture

(UC credit limitation) (No prerequisite)

The study of business law, both case and statutory, as it applies to the Uniform Commercial Code dealing with negotiable instruments; secured transactions and bankruptcy; employment law and agency; property, real and personal, to include bailments; and governmental agencies' regulation of business to include antitrust and fair business practices.

BADM 122 SMALL BUSINESS MANAGEMENT

Units: 3.0 [CSU](#) | 48-54 hours lecture

(No prerequisite)

An introduction to contemporary management techniques used by small businesses in the free enterprise system. The course focuses on entrepreneurial opportunities, developing a business plan for a planned or existing small business, small business marketing, operations, and financial management.

BADM 138 COOPERATIVE EDUCATION

See Cooperative Education listing (1-8 units) [CSU](#)

BADM 142 BUSINESS MATHEMATICS

Units: 3.0 [CSU](#) | 48-54 hours lecture

(No prerequisite)

An introduction to a variety of business computations and applications such as percents, payroll, markup/markdown, cash and trade discounts, simple and compound interest, annuities, credit, mortgages, financial statements and analysis, inventory, depreciation, taxes and securities.

BADM 144 BUSINESS COMMUNICATIONS

Units: 3.0 [CSU](#) | 48-54 hours lecture

(No prerequisite. Grade Option)

This course studies the principles and role of business communication and the need for proficient, legal, and ethical communication skills within current, professional, diverse, technological, and global environments. Emphasis is placed on verbal, nonverbal, and written communication to include persuasive, analytical, business letters, memorandums, and reports. The course also covers resumes and other employment-related correspondence. Students will develop planning, organizing, and outlining skills, as well as editing proficiency. Evaluates grammar skills and improves writing style.

BADM 148 SPECIAL TOPICS

See Special Topics listing (Variable units) [CSU](#)

BADM 149 INDEPENDENT STUDY

See Independent Study listing (1-3 units) [CSU](#)

Business Education Technologies

The study of Business Education Technologies is designed to prepare students for a variety of careers in high-tech business offices. Transfer level courses are available for students preparing for a bachelor's degree. The Associate in Science degree and Certificates of Achievement and Career Preparation are awarded.

Career Opportunities

Administrative Assistant, Data Entry, Desktop Publishing, Executive Secretary, General Clerk, Office Manager, Receptionist, Stenographer, Teacher, Typist, Transcription Machine Operator

Faculty

Barbara Becker | Becky Palmer - Emeritus

Degrees and Certificates Awarded

Associate in Science, Business Education Technologies
Computer Systems I Certificate
Data Typist Certificate
Medical Office Certificate
Spreadsheet Processor Certificate

Administrative Assistant Certificate
Computer Systems II Certificate
Legal Office Certificate
Office Services Certificate
Word Processor Certificate

Program Learning Outcomes

A student receiving a degree or certificate in this field will be able to:

- Demonstrate the ability to use software, and peripheral components at their own direction in a business environment.
- Implement and relate skills to communicate and produce professional business documents in an office environment.
- Demonstrate the ability to competently use a wide variety of office equipment.
- Demonstrate general research standards to analyze Online documentation to produce and integrate material.
- Demonstrate proper techniques to complete tasks thoroughly and precisely.

Associate Degree

To earn an Associate in Science degree with a major in Business Education Technologies (04943), complete 18 units from any of the certificate requirements or from any Business Education Technologies courses, and meet all Victor Valley College graduation requirements. BET 138 (Cooperative Education) may be used as Elective credit but may not be used to fulfill major requirements.

Transfer

Not usually a transfer major. Some Business Education Technologies courses fulfill subject credit requirements, but most transfer as electives. (Students pursuing a bachelor's degree in Business Administration should note that Business Education Technologies courses will typically not fulfill major requirements for transfer. See Business Administration for transfer requirements for that degree.)

The following CSU campuses offer a B.S. degree in Business Education for students who plan to teach business in grades 7-12:

- **California State University**

Los Angeles | Northridge

For further transferable courses, it is recommended to meet with your counselor, and visit www.assist.org.

Business Education Technologies

ADMINISTRATIVE ASSISTANT CERTIFICATE OF ACHIEVEMENT (10789)

This curriculum is designed to prepare students for employment in business/industry/government for higher-level executives. Duties include office supervision, word processing, maintaining office records and accounts.

Units Required: 31.0 - 32.0

All of the following must be completed:

Group I - All of the following must be completed (28 units):

BADM 106	Accounting Software Applications Part A	2.0
BET 112	Spreadsheet: Excel for Windows A/B/C	3.0
BET 100	Introduction to Computers	3.0
BET 104	Beginning Word Processing/Typing: Word for Windows A/B/C	3.0
BET 107	Internet A/B/C	3.0
BET 136	Career Applications for Word Processing	3.0
BET 141	Operating System: Windows A/B/C	3.0
BET 142	Office Technologies and Procedures	3.0
BET 74	Office Machine Calculations	3.0

Group II - Two courses must be completed from any of the following:

BET 77	Speed and Accuracy Development	2.0
BET 118	Database: Access A/B/C	3.0
BET 122	Intermediate Keyboarding/Typing A/B/C	3.0
BET 123T	Machine Transcription	3.0
BET 131	Presentation Software: Powerpoint A/B/C	3.0
BET 133	Microsoft Office	3.0
BET 137	Desktop Publishing: Microsoft Publisher A/B/C	3.0
ECON 101	Principles of Economics: Macro	3.0

COMPUTER SYSTEMS I CERTIFICATE OF CAREER PREPARATION

This curriculum is designed to prepare students for entry-level word processing or data entry positions.

Units Required: 10.0

All of the following must be completed:

Group I - 3 units

BET 104	Beginning Word Processing/Typing: Word for Windows A/B/C	3.0
---------	--	-----

Group II - 7 units of the following must be completed:

BET 68	Proofreading	3.0
BET 100	Introduction to Computers	3.0
BET 107	Internet A/B/C	3.0
BET 112	Spreadsheet: Excel for Windows A/B/C	3.0
BET 123T	Machine Transcription	3.0
BET 131	Presentation Software: Powerpoint A/B/C	3.0
BET 136	Career Applications for Word Processing	3.0
BET 143	Business English	3.0

Business Education Technologies

COMPUTER SYSTEMS II CERTIFICATE OF ACHIEVEMENT (10791)		
This curriculum is designed to prepare students for the modern computer office. It includes instruction in the most popular business software		
Units Required: 21.0		
<i>All of the following must be completed:</i>		
BET 104	Beginning Word Processing/Typing: Word for Windows A/B/C	3.0
BET 107	Internet Level A/B/C	3.0
BET 112	Spreadsheet: Excel for Windows A/B/C	3.0
BET 136	Career Applications for Word Processing	3.0
BET 141	Operating System: Windows A/B/C	3.0
BET 143	Business English	3.0
<i>One of the following must be completed:</i>		
BET 100	Introduction to Computers	3.0
BET 118	Database: Access A/B/C	3.0
BET 131	Presentation Software: Powerpoint A/B/C	3.0
BET 137	Desktop Publishing: Microsoft Publisher A/B/C	3.0
CIS 280	Fundamentals of Database Management Systems	3.0
SPREADSHEET PROCESSOR CERTIFICATE OF CAREER PREPARATION		
This curriculum is designed to prepare students for entry-level office/bookkeeping positions.		
Units Required: 3.0		
BET 112	Spreadsheet: Excel for Windows A/B/C	3.0
WORD PROCESSOR CERTIFICATE OF CAREER PREPARATION		
This curriculum is designed to prepare students for entry-level secretarial positions.		
Units Required: 3.0		
BET 104	Beginning Word Processing/Typing: Word for Windows A/B/C	3.0
DATA TYPIST CERTIFICATE OF CAREER PREPARATION		
This curriculum is designed to prepare students for entry-level positions as a data entry operator. Duties for this position include general clerical tasks, data entry, and word processing.		
Units Required: 12.0 - 14.0		
<i>Group I - All of the following must be completed:</i>		
BET 104	Beginning Word Processing/Typing: Word for Windows A/B/C	3.0
BET 124	Records Management	3.0
<i>Group II - 6 units of the following must be completed:</i>		
BET 68	Proofreading	3.0
BET 77	Speed and Accuracy Development	2.0
BET 107	Internet A/B/C	3.0
BET 118	DataBase: Access	3.0
BET 122	Intermediate Keyboarding/Typing	3.0
BET 123T	Machine Transcription	3.0
BET 137	Desktop Publishing: Microsoft Publisher A/B/C	3.0
BET 141	Operating System: Windows A/B/C	3.0
BET 143	Business English	3.0
BET 145	Communication for Business	3.0
CIS 280	Fundamentals of Database Management Systems	3.0

Business Education Technologies

MEDICAL OFFICE CERTIFICATE OF ACHIEVEMENT (07546)

This curriculum is designed to prepare students to effectively carry out front medical office functions. Administrative duties include scheduling and receiving patients, maintaining medical records, office accounts, insurance forms, and transcription. See Medical Assistant for a program which includes both front and back office preparation and a clinical component.

Units Required: 31.0

All of the following must be completed:

ALDH 80	Pharmacology	3.0
ALDH 81	Medical Insurance	3.0
ALDH 82	Medical Office Procedures	4.0
ALDH 139	Medical Terminology	3.0
BET 104	Beginning Word Processing/Typing: Word for Windows A/B/C	3.0
BET 123M	Machine Transcription-Medical	3.0
BET 124	Records Management	3.0
BET 136	Career Applications for Word Processing	3.0
BET 142	Office Technologies and Procedures	3.0

One of the following must be completed:

BET 143	Operating System: Windows A/B/C	3.0
BET 68	Proofreading	3.0
BET 100	Introduction to Computers	3.0
BET 112	Spreadsheet: Excel for Windows A/B/C	3.0
BET 118	Database: Access A/B/C	3.0
BET 131	Presentation Software: Powerpoint A/B/C	3.0
BET 141	Operating System: Windows A/B/C	3.0
BET 143	Operating System: Windows A/B/C	3.0

OFFICE SERVICES CERTIFICATE OF CAREER PREPARATION

This curriculum is designed to prepare students for entry-level positions in the clerical field and as a receptionist. Entry-level duties include general clerical tasks, filing, and word processing.

Units Required: 12.0

Group I -All of the following must be completed:

BET 104	Beginning Word Processing/Typing: Word for Windows A/B/C	3.0
BET 124	Records Management	3.0

Group II - 6 units of the following must be completed:

BET 68	Proofreading A/B/C	3.0
BET 74	Office Machine Calculations	3.0
BET 107	Internet A/B/C	3.0
BET 112	Spreadsheet: Excel for Windows A/B/C	3.0
BET 118	Database: Access A/B/C	3.0
BET 122	Intermediate Keyboarding/Typing	3.0
BET 123T	Machine Transcription	3.0
BET 131	Presentation Software: Powerpoint A/B/C	3.0
BET 137	Desktop Publishing: Microsoft Publisher	3.0
BET 142	Office Technologies and Procedures	3.0
BET 143	Business English	3.0

Business Education Technologies

LEGAL OFFICE CERTIFICATE OF ACHIEVEMENT (07545)		
This curriculum is designed to prepare students to become a productive secretary in a modern legal office. Duties include maintaining records, word processing, transcription, and general legal office tasks.		
Units Required: 27.0		
<i>Group I - All of the following must be completed:</i>		
BADM 117	Legal Environment of Business	3.0
BET 74	Office Machine Calculations	3.0
BET 104	Beginning Word Processing/Typing: Word for Windows A/B/C	3.0
BET 123L	Machine Transcription-Legal	3.0
BET 124	Records Management	3.0
BET 136	Career Applications for Word Processing	3.0
BET 142	Office Technologies and Procedures	3.0
<i>Group II - one course of the following must be completed:</i>		
BET 68	Proofreading	3.0
BET 143	Business English	3.0
<i>one course must be chosen from one of the following:</i>		
BET 100	Introduction to Computers	3.0
BET 112	Spreadsheet: Excel for Windows A/B/C	3.0
BET 118	Database: Access A/B/C	3.0
BET 131	Presentation Software: Powerpoint A/B/C	3.0
BET 141	Operating System: Windows A/B/C	3.0
BET 145	Communications for Business	3.0

Business Education Technologies Courses

BET 68 PROOFREADING

Units: 3.0 | **144-162 hours laboratory**

(No prerequisite. Recommended preparation: BET 104, 104A, 104B or 104C)

Students develop proofreading skills necessary to meet high levels of accuracy and review basic business English skills: punctuation, word usage, sentence and paragraph structure. Practice/exercises are done on the microcomputer for Modules B and C.

BET 74 OFFICE MACHINE CALCULATIONS

Units: 3.0 | **32-36 hours lecture and 48-54 hours laboratory.**

(No prerequisite)

Provides practice on ten-key calculating machine with applications of actual business problems and forms.

BET 77 SPEED AND ACCURACY DEVELOPMENT

Units: 2.0 | **32-36 hours lecture or 64-72 hours individualized instruction**

(No prerequisite)

This course is designed to fit the needs of each student and develops keyboarding/typing speed for continuing to higher level courses or developing job skills by intensive training and practices.

Business Education Technologies Courses

BET 100 INTRODUCTION TO COMPUTERS

Units: 3.0 **CSU** | 32-36 hours lecture and 48-54 hours laboratory

(No prerequisite)

This course is directed to those with little or no computer experience. It will introduce basic essential elements of computers such as: power up, hardware components, evolution of computers, types of personal computers, the input-process-output cycle, desktop components, email, and the World Wide Web. Introduction to use of office software including Word, Excel and Powerpoint.

BET 101 BEGINNING KEYBOARDING/TYPING

Units: 1.0 **CSU** | 8-9 hours lecture and 24-27 hours laboratory or 32-36 hours individualized instruction

(No prerequisite)

This course is individualized to fit the needs of each student and develop basic alpha/numeric keyboarding skills and basic mouse operation on the computer. Emphasis is on achieving a straight-copy speed of 20 gross words a minute with a predetermined error limit.

BET 104 BEGINNING WORD PROCESSING/TYPING: WORD FOR WINDOWS A/B/C

Units: 3.0 **CSU** | 48-54 hours lecture or 96-108 hours individualized instruction

(No prerequisite. Grade Option)

This course introduces students to Word for Windows. Students will develop a working knowledge of this current software package to prepare documents.

BET 107 INTERNET A/B/C

Units: 3.0 **CSU** | 48-54 hours lecture or 96-108 hours individualized instruction

(No prerequisite. Grade Option.)

This course is designed to teach students concepts and business skills of the Internet including creating an e-mail account; creating, editing, and printing effective web pages; and understanding Internet technologies and security.

BET 112 SPREADSHEET: EXCEL FOR WINDOWS A/B/C

Units: 3.0 **CSU** | 48-54 hours lecture or 144-162 hours laboratory or 96-108 hours individualized instruction

(No prerequisite. Grade Option.)

This course offers spreadsheet operations for creating, editing, formatting and enhancing charts in worksheets. Students learn to manage workbooks and prepare them for the web. Students plan, create, and then filter lists using Excel's database.

BET 118 DATABASE: ACCESS A/B/C

Units: 3.0 **CSU** | 48-54 hours lecture, or 96-108 hours individualized instruction

(No prerequisite. Grade Option.)

Familiarity with computers is recommended. Introduces database concepts through advanced skill levels including advanced queries, briefcase replication, macros and use of Visual Basic for applications code.

BET 122 INTERMEDIATE KEYBOARD/TYPING

Units: 3.0 **CSU** | 48-54 hours lecture

(No prerequisite)

This course is designed to build speed and skills learned in Beginning Typing/Keyboarding, using the current version of Microsoft Word and Keyboarding Pro with an emphasis on attaining straight copy rate of 45-60 gross wpm with a predetermined error limit.

Additionally, students will develop skills needed to effectively format a variety of business documents.

BET 123L MACHINE TRANSCRIPTION – LEGAL

Units: 3.0 **CSU** | 48-54 hours lecture. May also be offered as 96-108 hours individualized instruction

(No prerequisite. Recommended preparation: BET 104)

Students develop machine transcription skills used in a typical law firm and learn to prepare legal documents and correspondence.

Business Education Technologies Courses

BET 123M MACHINE TRANSCRIPTION – MEDICAL

Units: 3.0 CSU | 48-54 hours lecture. May also be offered as 96-108 hours individualized instruction

(No prerequisite. Recommended preparation: BET 104)

Students develop machine transcription skills for a medical transcriber and learn the use and meaning of medical terminology used in the Allied Health field.

BET 123T MACHINE TRANSCRIPTION

Units: 3.0 CSU | 48-54 hours lecture

(No prerequisite)

Principles and procedures of establishing and maintaining current record systems with detailed instruction and practice in the use of alphabetic, geographic, numeric, and subject filing systems as defined by the current Association of Records Managers and Administrator standards.

BET 124 RECORDS MANAGEMENT

Units: 3.0 CSU | 48-54 hours lecture

(No prerequisite)

This course is designed to teach students concepts and business skills of PowerPoint including creating, editing, and printing effective presentations. Students learn advanced PowerPoint features such as creating graphs and tables, and customizing, and inserting artwork, WordArt, and slide show effects. Students learn concepts and business skills of PowerPoint. The concepts and skills include working with embedded and linked objects, hyperlinks, and delivering and publishing presentations.

BET 131 PRESENTATION SOFTWARE: POWERPOINT ABC

Units: 3.0 CSU | 48-54 hours lecture or 144-162 hours laboratory or 96-108 hours individualized instruction

(No prerequisite. Grade Option)

This course is designed to teach students concepts and business skills of PowerPoint including creating, editing, and printing effective presentations. Students learn advanced PowerPoint features such as creating graphs and tables, and customizing, and inserting artwork, WordArt, and slide show effects. Students learn concepts and business skills of PowerPoint. The concepts and skills include working with embedded and linked objects, hyperlinks, and delivering and publishing presentations.

BET 133 MICROSOFT OFFICE

Units: 3.0 CSU | 48-54 hours lecture

(No prerequisite. Grade Option)

This class is designed to introduce students to the basic functions of Microsoft Office Word, Excel, PowerPoint, and Access, as well as a brief overview of operating systems and the Internet.

BET 136 CAREER APPLICATIONS FOR WORD PROCESSING

Units: 3.0 CSU | 48-54 hours lecture

(No prerequisite. Recommended preparation: Successful completion of BET 104 or BET 103. Ability to use word processing functions to create, format and edit advanced business documents. Grade Option)

This course is designed for the student who is familiar with word processing functions and formatting principles. Topics will include terminology and methodology used in a variety of business careers by applying formatting and keyboarding skills to complex professional documents including letters, memos, forms, tables and reports.

BET 137 DESKTOP PUBLISHING: MICROSOFT PUBLISHER

Units: 3.0 CSU | 48-54 hours lecture

(No prerequisite)

This class is designed to teach students practical, professional quality publications using the current version of Microsoft Publisher.

Business Education Technologies Courses

BET 138 COOPERATIVE EDUCATION

See Cooperative Education listing (1-8 units). [CSU](#)

BET 141 OPERATING SYSTEM: WINDOWS A/B/C

Units: 3.0 [CSU](#) | 96-108 hours individualized instruction

(No prerequisite. Grade Option)

Introduction to Windows operating system and features through extensive hands-on exercises.

BET 142 OFFICE TECHNOLOGIES AND PROCEDURES

Units: 3.0 [CSU](#) | 48-54 hours lecture

(No prerequisite. Grade Option)

Students will learn practical application of current automated office procedures, duties, and human relations. Specific topics include telephone, electronic mail, Internet activities, data entry, reference resources, job seeking, mail and shipping services and procedures, office relations, office etiquette and dress, time management, travel arrangements, meetings, minutes, and office equipment. Development of critical thinking skills and decision-making skills throughout the course.

BET 143 BUSINESS ENGLISH

Units: 3.0 [CSU](#) | 48-54 hours lecture

(No prerequisite. Grade Option)

This is a technical course to develop a proficiency in written business communication. A comprehensive review of proof-reading, grammar, punctuation, sentence structure, and letter and memo formats emphasizing the function of business English in various types of business communications.

BET 145 COMMUNICATIONS FOR BUSINESS

Units: 3.0 [CSU](#) | 48-54 hours lecture

(No prerequisite. Recommended preparation: BET 104 It is recommended that students have basic computer/Internet skills, including the ability to download documents; use basic word processing to create, open, and save documents in either RTF or Word format; send and receive emails; and navigate the Internet and various websites. Grade Option)

This course is designed for Business Education Technologies to create proficiency in the mechanics of writing, reading, and critically analyzing various types of business correspondence. Principles of communication psychology as they apply to human relations are employed to solve business communications problems, and writing styles in business correspondence and report format are analyzed. Grammar, proofreading, and editing are reviewed.

BET 148 SPECIAL TOPICS

See Special Topics listing (Variable units)., [CSU](#)

BET 149 INDEPENDENT STUDY

See Independent Study listing (1-3 units). [CSU](#)

Business Real Estate and Escrow

This program is designed to provide the student with the comprehensive knowledge needed to enter or invest in the real estate industry. A progressively challenging course curriculum starts with the Principles class, learning the language of real estate. This is a state-mandated course for those testing for a real estate salesperson's license. From there an "investor" student might pursue the more difficult Finance, Law, or Appraisal courses. The certificate program provides a structured approach to the course work. The Business Real Estate Apprentice Certificate includes the courses and electives necessary to take the state's Real Estate Salesperson's examination.

The single largest business transaction entered into by most people is the sale or purchase of a home or other real estate. Consequently, people often seek the professional opinions and assistance of real estate salespersons, brokers, and appraisers. These professionals are familiar with the various forms of financing available in any given market. They keep abreast of actions taken by their county or city planners and become familiar with the zoning laws, tax laws, and real estate and contract law in order to better serve their clients. Real estate agents and brokers are not limited to selling real estate for they can also manage or develop property.

Career Opportunities

Banking Developer, Escrow Officer, Escrow Secretary, Loan Broker/Salesman, Property Manager, Real Estate Appraiser, Real Estate Broker, Real Estate Lawyer, Real Estate Salesperson, Real Estate Secretary, Securities Broker, Title Insurance Representative

Faculty

Chris Grover

Degrees and Certificates Awarded

Associate in Science, Business Real Estate and Escrow

Basic Business Real Estate Certificate

Business Real Estate Apprentice Certificate

Program Learning Outcomes

A student receiving a degree or certificate in this field will be able to:

- Demonstrate the ability to use software, and peripheral components at their own direction in a business environment.
- Demonstrate the ability to competently use a wide variety of office equipment.
- Demonstrate general research standards to analyze Online documentation to produce and integrate material.
- Demonstrate proper techniques to complete tasks thoroughly and precisely

Associate Degree

To earn an Associate in Science degree with a major in Business Real Estate and Escrow (10788), complete a minimum of 18 units from any of the certificate requirements or from any Business Escrow or Business Real Estate courses, and meet all Victor Valley College graduation requirements. BESC and BRE 138 (Cooperative Education) may be used as Elective credit but may not be used to fulfill major requirements.

Transfer

Not usually a transfer major. Many Business Escrow and Business Real Estate courses transfer as Electives or fulfill subject credit requirements. Students in this program often choose to pursue a bachelor's degree in Business Administration. See Business Administration for transfer requirements.

Business Real Estate and Escrow

BUSINESS REAL ESTATE APPRENTICE CERTIFICATE OF CAREER PREPARATION

To sit for the real estate salesperson's exam, California Real Estate Law requires that prospective real estate licensees complete college level courses in Real Estate Principles, Real Estate Practices and one additional elective from the Group II list. This certificate program provides students with courses they need to comply with that law. This certificate, along with the successful completion of the California Real Estate Salesperson's exam, enables students to obtain employment as a real estate licensee within the state of California

Units Required: 9.0

Group I - The following must be completed with a grade of "C" or better:

BRE 100	Real Estate Principles	3.0
BRE 101	Real Estate Practices	3.0

Group II- Any one of the following must be completed with a grade of "C" or better:

BRE 110	Legal Aspects of Real Estate I	3.0
BRE 120	Real Estate Appraisal	3.0
BRE 126	Real Estate Finance	3.0
BRE 127	Real Estate Office Administration	3.0
BRE 139	Real Estate Economics	3.0
BRE 140	Real Property Management	3.0

BASIC BUSINESS REAL ESTATE CERTIFICATE OF ACHIEVEMENT (04942)

This certificate program thoroughly prepares the student to become a professional real estate sales-person in the state of California.

Units Required: 18.0

Group I - All of the following must be completed:

BRE 100	Real Estate Principles	3.0
BRE 110	Legal Aspects of Real Estate I	3.0
BRE 120	Real Estate Appraisal	3.0
BRE 126	Real Estate Finance	3.0
BRE 142	Real Estate Marketing	3.0

Group II - Either one of the following must be completed:

BRE 101	Real Estate Practices	3.0
BADM 103	Financial Accounting Fundamentals	3.0

Business Escrow Courses

BESC 138 COOPERATIVE EDUCATION

See Cooperative Education listing (1-8 units). [CSU](#)

BESC 148 SPECIAL TOPICS

See Special Topics listing (Variable units). [CSU](#)

BESC 149 INDEPENDENT STUDY

See Independent Study listing (1-3 units). [CSU](#)

Business Real Estate Courses

These classes are open to all students with an interest in Real Estate. They are not just for Licensees.

BRE 60 ADVANCED REAL ESTATE APPRAISAL: COMPLIANCE AND REVIEW PROCEDURES

Units: 3.0 | 48-54 hours lecture

(No prerequisite)

This course draws on the disciplines of real estate brokerage, finance, banking and appraisal with special attention to loss reduction due to underwriting and appraisal errors. Students with prior experience in the banking, mortgage, or appraisal industries will appreciate this course, however all are welcome. This course enhances the student's ability to analyze, understand and correct errors in real estate appraisals on federally required underwriting forms, narrative reports and electronic data exchanges. Discussion topics include appraisal analysis, valuation trends, demographic and census interpolation, reporting, communication and review. Uniform Standards of Professional Appraisal Practice will be discussed in relation to the forms reviewed. An advanced appraisal course acts as an elective for California Real Estate Broker's license.

BRE 61 ADVANCED REAL ESTATE APPRAISAL: LAND VALUATIONS

Units: 3.0 | 48-54 hours lecture

(No prerequisite)

This course offers investigative techniques used to analyze and evaluate data leading to land valuation reports. Topics include discussion of soils analysis, topographic study, market analysis, environmentally affected properties, subdivisions and more. This is an advanced appraisal course and acts as an elective for the California Real Estate Broker's license.

BRE 62 ADVANCED REAL ESTATE APPRAISAL: THE NARRATIVE REPORT

Units: 1.0 | 16-18 hours lecture

(No prerequisite)

This course offers and demonstrates the techniques designed to assist appraisers in effectively communicating the results of their valuation processes. Special emphasis is placed on the narrative portion of the form and/or complete self-contained type reports.

BRE 100 REAL ESTATE PRINCIPLES

Units: 3.0 | **CSU** | 48-54 hours lecture

(No prerequisite)

Introductory course stressing the study of basic information in fundamental subjects in the field of real estate. Topics include legal aspects, legal descriptions, encumbrances, financing, escrow, contracts, taxation, subdivisions and zoning, appraisal, landlord/tenant relations, and arithmetic. Successful completion of this course makes you eligible to test for the California Department of Real Estate Salesperson's license. Elective for the Real Estate Broker's license.

BRE 101 REAL ESTATE PRACTICES

Units: 3.0 | **CSU** | 48-54 hours lecture

(No prerequisite)

Working practices in office listings and sales methods leading to competence. General basic course leading toward professionalism in real estate practice. Advanced topics involve prospecting and listing techniques, real estate agency and disclosure, selling and marketing techniques, advertising, office operations, finance, property management and real estate investment. The course meets the educational requirements and is required by the California Department of Real Estate before testing for both the California Real Estate Salesperson's license and the California Real Estate Broker's license.

BRE 110 LEGAL ASPECTS OF REAL ESTATE I

Units: 3.0 | **CSU** | 48-54 hours lecture

(No prerequisite)

A practical, applied study of California Real Estate law which will explore difficulties arising from real estate transactions, instruments, zoning, and planning. This class is required for the California Real Estate Broker's license and meets an elective educational requirement for the California Real Estate Salesperson's license

Business Real Estate Courses

BRE 120 REAL ESTATE APPRAISAL

Units: 3.0 **CSU** | 48-54 hours lecture

(No prerequisite)

This course examines narrative appraisal reports, theories of valuation, studies in specific properties, neighborhood data, market research, cost analysis, causes of depreciation, and how to treat the misplaced valuation of residential properties. Course also covers how to start an effective "appraisal plan" and sources of information. Required course for Real Estate Broker's license. Meets the educational requirements as an elective for the California Real Estate Salesperson's license.

BRE 121 ADVANCED REAL ESTATE APPRAISAL: INCOME PROPERTY

Units: 3.0 **CSU** | 48-54 hours lecture

Elective for Broker's License. (No prerequisite)

Special emphasis given to income properties, how to obtain significant data and relate to the subject property, the importance of thorough research, and the introduction of capitalization methods. This class is an elective for California Real Estate Broker's license.

BRE 126 REAL ESTATE FINANCE

Units: 3.0 **CSU** | 48-54 hours lecture

Advanced Finance course for Real Estate Broker License (No prerequisite)

This course offers a practical applied study and analysis of money markets, interest rates, and real estate financing with actual case illustrations. Cases demonstrate lending policies, problems, and rules involved in financing commercial and special purpose properties. This course is required for the Real Estate Broker's license and meets the educational requirements as an elective for the California Real Estate Salesperson's license.

BRE 127 REAL ESTATE OFFICE ADMINISTRATION

Units: 3.0 **CSU** | 48-54 hours lecture

(No prerequisite)

Designed for practicing real estate brokers, managers, or salespersons who plan to open their own office. This course emphasizes factors for success in real estate brokerage. Topics discussed include office location, organization, marketing, accounting, finance, property management, development and professional relations. elective for the Real Estate Broker's and Real Estate Salesperson's license.

BRE 139 REAL ESTATE ECONOMICS

Units: 3.0 **CSU** | 48-54 hours lecture

(No prerequisite)

This course offers a study of the economic aspects that impact real estate values and land use. Included is the government's role in the economy, money and credit, community growth patterns, land use controls, and the economic principles of capitalism. This class is required for the California Real Estate Broker's license and meets the educational requirements as an elective for the California Real Estate Salesperson's license.

BRE 138 COOPERATIVE EDUCATION

See Cooperative Education listing (1-8 units) **CSU**

BRE 140 REAL PROPERTY MANAGEMENT

Units: 3.0 **CSU** | 48-54 hours lecture

(No prerequisite)

Professional approach to the principles and practices of managing income properties. Topics include leases, rent schedules, collections, evictions, budgets, purchasing, market economics, taxation, maintenance, and record keeping. Elective for the Real Estate Broker's license. Meets the educational requirements as an elective for the California Real Estate Salesperson's license.

Business Real Estate Courses

BRE 142 REAL ESTATE MARKETING

Units: 3.0 **CSU** | 48-54 hours lecture

(No prerequisite)

A study of the principles and processes involved in professionally marketing real estate. Course content includes: communication and marketing skills as practiced within the real estate industry, real estate advertising, target marketing, development of a marketing plan, product knowledge, people knowledge, qualifying both the buyer and the seller, negotiating and financing skills, and closing the escrow. Development of marketing tools including signs, maps, mail-outs, brochures, referrals, forms and media campaigns will also be covered.

BRE 148 SPECIAL TOPICS

See Special Topics listing (Variable units), CSU

BRE 149 INDEPENDENT STUDY

See Independent Study listing (1-3 units), CSU

Chemistry

Chemistry is a central science. It is an integral part of biological, geological, medical and environmental sciences. Every sight, sound, touch, smell, taste, and even thought is a result of chemical processes. An understanding of chemistry helps to make sound decisions in our increasingly technological society.

Courses for non-majors are offered in addition to the rigorous sequence designed for majors and transfer students.

Career Opportunities

Agricultural Technician, Analytical Chemist, Biochemist, Synthetic Organic Chemist, Environmental Chemist and Attorney
Geochemist, Chemical Engineer, Materials Scientist, Pharmaceutical Technician, Laboratory Technician, Science Teacher
Technical Salesperson

Faculty

Thomas Basiri - Emeritus | Thomas Kennedy

Degrees and Certificates Awarded

Associate in Arts, Liberal Arts, Mathematics/Science Emphasis

Associate in Science, Math/Science

Associate Degree

No associate degree is offered with a major in Chemistry. Chemistry courses may be used to fulfill requirements for an Associate in Science degree with a major in Math/Science or an Associate of Arts degree with a major in Liberal Arts with an emphasis in Math/Science. See respective listings for each major. CHEM 138 (Cooperative Education) may be used as elective credit, but may not be used to fulfill major requirements.

Transfer

For the most up-to-date information on these programs and others, visit www.assist.org. Please stop by the Transfer Center in Building 55 or make an appointment with a counselor if you have questions.

- **California State University, San Bernardino:** Chemistry major | Biochemistry major
- **University of California, Riverside:** Chemistry major | Biochemistry major

Chemistry Courses

CHEM 100 INTRODUCTORY CHEMISTRY

Units: 4.0 [CSU, UC](#) | 48-54 hours lecture and 48-54 hours laboratory

(Prerequisite: MATH 42 with a grade of "C" or better.) (UC credit limitation)

An introductory course in general, organic, and biological chemistry. This course is specifically designed for students preparing for careers in allied health, such as nursing and various fields of therapy. The course satisfies general education requirements for non-majors and assumes no background in chemistry. Basic math skills are highly recommended.

CHEM 128 SPECIAL TOPICS

See Special Topics listing (Variable units). [CSU](#)

CHEM 138 COOPERATIVE EDUCATION

See Cooperative Education listing (1-8 units). [CSU](#)

CHEM 150 FORENSIC CHEMISTRY

Units: 4.0 [CSU](#) | 48-54 hours lecture and 48-54 hours laboratory

(No prerequisite)

This course is designed to provide an introduction to forensic chemistry and criminalistics. The course introduces chemical and scientific techniques used in modern forensic laboratories to analyze physical evidence commonly encountered at a crime scene. Topics include a basic survey of the principles of general and organic chemistry as applied to forensic examination, forensic documentation, chemical screening, microcrystal, and extraction techniques, an introduction to chromatography, mass spectrometry, and infrared spectroscopy, analysis of various drugs and controlled substances, and the investigation and processing of clandestine laboratory operations. A close relationship between theoretical lecture principles and field and laboratory techniques is emphasized.

CHEM 201 GENERAL CHEMISTRY

Units: 5.0 **CSU, UC** | 48-54 hours lecture and 96-108 hours laboratory

(Prerequisite: CHEM 100 with a grade of 'C' or better, and MATH 90 or higher)

Theories of atomic structure and the application of these theories to an understanding of bonding, solution processes, state of matter, gas laws, general properties of matter, and principles of stoichiometric calculations.

Laboratory emphasis on the development of experimental skills, the calculations and significance of experimental data.

CHEM 202 GENERAL CHEMISTRY

Units: 5.0 **CSU, UC** | 48-54 hours lecture and 96-108 hours laboratory

(Prerequisite: CHEM 201 with a grade of "C" or better, and MATH 90 or higher with a grade of "C" or better)

Use of atomic theory developed in Chemistry 201 to examine the principles of periodic classification of the elements, thermodynamics, acids and bases, chemical equilibrium, reaction kinetics, coordination compounds. A basic survey of nuclear, organic, and biochemistry is included. Laboratory emphasis is on the development of technical skills.

CHEM 206 INTRODUCTORY CHEMISTRY II: ORGANIC CHEMISTRY

Units: 4.0 **CSU, UC** | 48-54 hours lecture and 48-54 hours laboratory

(UC credit limitation) (Prerequisite: CHEM 100 with a grade of "C" or better.)

An introduction to fundamental concepts of Organic Chemistry for students entering professional careers in allied health. Emphasis is on the structure, reactivity and mechanisms, chemical properties and nomenclature of major organic functional groups and their relationship to biological systems.

CHEM 207 INTRODUCTORY CHEMISTRY III: BIOCHEMISTRY

Units: 4.0 **CSU, UC** | 48-54 hours lecture and 48-54 hours laboratory

(Prerequisite: CHEM 206 with a grade of "C" or better. Recent completion of CHEM 206 or equivalent is recommended.)

A one semester survey course in the fundamental principles of biochemistry for students entering professional careers in allied health. Emphasis is on the structure, function and physiological role of carbohydrates, lipids, proteins and nucleic acids.

CHEM 281 ORGANIC CHEMISTRY I

Units: 4.0 **CSU, UC** | 48-54 hours lecture and 48-54 hours laboratory

(Prerequisite: CHEM 202 with a grade of "C" or better.)

An introduction to general principles of organic chemistry covering the structures, properties and reactivity of organic compounds. Emphasis is on molecular orbital theory, functional group reactivity, nomenclature, substitution and elimination mechanisms, stereochemistry, chemical equilibria and spectroscopy. Laboratory techniques include isolation, purification, synthetic procedures and spectroscopy. This is the first semester of a two semester sequence.

CHEM 282 ORGANIC CHEMISTRY II

Units: 4.0 **CSU, UC** | 48-54 hours lecture and 48-54 hours laboratory

(Prerequisite: CHEM 281 with a "C" or better.)

Principles and experimental techniques developed in CHEM 281 are extended to include synthesis and identification, nomenclature, derivatives, spectroscopy, and reactions of functional groups, heterocycles, and aromatic compounds. Biochemistry of carbohydrates, lipids, proteins, nucleic acids, and other biologically significant compounds is also examined.

Child Development

The Child Development program provides courses that prepare students to enter the field of early childhood education. Courses are designed to give students fundamental skills in working with children in a variety of settings, as well as a strong theoretical understanding of children's development.

Career Opportunities

Infant/Toddler Caregiver, Early Childhood Teacher, Early Childhood Program Administrator, Family Child Care Provider
Child Life Specialist, Elementary School Teacher, Early Intervention Teacher, Nanny, Social Worker, Therapist

Faculty

Marsha (Dee Dee) Cole | Sandy Visser-Jones

Degrees and Certificates Awarded

Associate in Science, Child Development Associate in Science for Transfer in Early Childhood Education (AS-T)
Level I: Associate Teacher Certificate of Achievement Level II: Teacher (preschool) Certificate of Achievement
Level III: Site Supervisor (preschool) Certificate of Achievement

Program Learning Outcomes

A student receiving a degree or certificate in this field will be able to:

- Integrate knowledge of the needs, the characteristics, and multiple influences on development of children birth to age eight as related to high quality care and education of young children.
- Design, implement, and evaluate environments and activities that support positive, developmental play and learning outcomes for all young children.
- Apply effective guidance and interaction strategies that support all children's social learning, identity, and self-confidence.
- Develop and implement strategies that promote partnerships between programs, teachers, families, and their communities.
- Apply ethical standards and professional behaviors that demonstrate understanding and knowledge, deepening the commitment to the early care and education profession.

Associate Degree

To earn an Associate in Science degree with a major in Child Development (10802), complete **CHDV** 100, 106, 110, 142, 150, 160, 200, 210, and meet all other Victor Valley College Associate Degree graduation requirements.

To earn an Associate of Science degree for Transfer with a major in Early Childhood Education, complete the required major courses and all other requirements specified on the following pages (i.e. 60CSU transfereable units, CSU GE or IGETC, etc). For more information on the AA-T/AS-T degrees, meet with a counselor or go to www.adegreewithaguarantee.com

Transfer

For the most up-to-date information on these programs and others, visit www.assist.org. Please stop by the Transfer Center in Building 55 or make an appointment with a counselor if you have questions.

- **California State University, San Bernardino:** *Human Development major*

For information, you may wish to contact CSUSB's Human Development department at (909) 537-5570.

- **University of California, Riverside:** *Human Development major*

Local Bachelors Programs - For information on the following programs located in the High Desert, please visit: www.vvc.edu/offices/transfer-center and select "Counseling Information Sheets":

- **Azusa Pacific University, High Desert Regional Center:** *Human Development major*
- **Brandman University, Victor Valley Campus:** *Early Childhood Development major*
- **University of La Verne, High Desert Campus:** *Child Development major*

Early Childhood Education, AS-T (31802)		
Program Requirements: 25 units		
Required Courses (25 units total)		
CHDV 100	Child Growth and Development	3.0
CHDV 106	Child, Family and Community	3.0
CHDV 110	Principles and Practices of Teaching Young Children	3.0
CHDV 142	Health, Safety and Nutrition	3.0
CHDV 150	Introduction to Curriculum	3.0
CHDV 160	Observation and Assessment	3.0
CHDV 200	Teaching in a Diverse Society	3.0
CHDV 210	Practicum	4.0
*Students are allowed to double count one of these courses (CHDV 100 or 106) for their General Education requirements so that they stay within the 60 units for the TMC.		
A student wishing to pursue an AA-T/AS-T degree in the major listed on this page must ensure the CSU of their choice is accepting that similar major. Students completing an AA-T/AS-T degree are guaranteed admissions into a CSU campus given that a student fulfills the following:		
<ol style="list-style-type: none"> 1) 60 CSU transferable units; 2) Completes the CSU General Education (GE) or IGETC General Education pattern; 3) Completes the major requirements for the AA-T/AS-T; 4) Maintains a transferable cumulative GPA of at least 2.0 (C or better); 5) Completes the basic/Golden 4 GE requirements. 		
For more information on the AA-T/AS-T degrees, meet with a counselor or visit www.adegreewithaguarantee.com		

Child Development

LEVEL I: ASSOCIATE TEACHER (PRE SCHOOL) CERTIFICATE OF ACHIEVEMENT (04969)

State and Federally Funded programs such as Head Start and State Preschool: This certificate satisfies all educational requirements for the Associate Teacher Permit, issued by the State of California. Students must also show evidence of meeting the Experience Requirement before applying for the Permit (see below). Permit applications can be obtained through the Child Development Department.

Private (Title 22) programs: This certificate satisfies all educational requirements to be a fully qualified preschool teacher in such programs.

Units Required: 22.0

All of the following must be completed with a grade of "C" or better:

ENGL 50	Writing Fundamentals or	4.0
ENGL 101	<i>English Composition</i>	4.0
CHDV 100	Child Growth and Development	3.0
CHDV 106	Child, Family, and Community	3.0
CHDV 110	Principles and Practices of Teaching Young Children	3.0
CHDV 142	Health, Safety and Nutrition	3.0
CHDV 150	Introduction to Curriculum	3.0
CHDV 160	Observation and Assessment	3.0

All course work must be completed with a "C" or better.

Experience Requirement necessary to apply for Child Development Permit. Students must complete 50 days of experience, of 3 or more hours per day, within the last two years. (THIS IS NOT NECESSARY FOR OBTAINING CERTIFICATE) Choose A or B:

Option A – For students already working in the field.

A Verification of Experience Form must be completed and submitted with Permit Application.

Option B – For students with no work experience in the field.

CHDV 210 Practicum and 2 units of **CHDV 138** (Work Experience) spread over two terms, completed within the last two years.

Please note: Returning students may substitute CHDV 127A for CHDV 110 Principles and Practices. Submit the "Course Substitution for Certificate Requirements" form, which can be obtained in the Admission and Records and Counseling Departments.

LEVEL II: TEACHER (PRE SCHOOL) CERTIFICATE OF ACHIEVEMENT (07589)

This certificate satisfies all requirements for the Teacher Permit, issued by the State of California. The permit qualifies one to hold positions at the teacher level in State and Federally Funded programs such as Head Start and State Preschool. Choose either Option A or Option B. (Permit applications can be obtained through the Child Development Department.)

Units Required: 45.0

Option A – For students already working in the field.

All of the courses required for the Associate Teacher Certificate. PLUS:

CHDV 200	Teaching in a Diverse Society	3.0
CHDV 210	Practicum	4.0

16 General Education Units (Must be Associate Degree Applicable), including one in each of the following categories.

English (in addition to Eng 50) | Humanities | Social Science (Cannot be CHDV 106 or 106) | Math or Science

All course work must be completed with a “C” or better.

Experience Requirement necessary to apply for the Child Development Permit: Evidence of working in an early childhood program for 175 days of 3+ hours per day within the past 4 years. Use the Verification of Experience Form, which is included in the Permit Application, to document this experience. (THIS IS NOT NECESSARY FOR OBTAINING CERTIFICATE)

Option B – For students with no work experience in the field.

All of the courses required for the Associate Teacher Certificate, plus completion of all other requirements for the A.S. degree in Child Development.

(See a counselor to identify specific courses which will facilitate transfer to a university.)

LEVEL III: SITE SUPERVISOR (PRE SCHOOL) CERTIFICATE OF ACHIEVEMENT (07591)

This certificate satisfies all EDUCATIONAL requirements for the Site Supervisor Permit, issued by the State of California. This permit qualifies one to hold positions at the Site Supervisor level in State and Federally Funded programs such as Head Start and State Preschool. (See note below for information on how to obtain the EXPERIENCE requirements.)

Units Required: 60.0 | *Certificate Requirements Include:*

ALL of the courses required for the Associate of Science Degree in Child Development including:

Child Development Courses: **CHDV 100, 106, 110, 142, 150, 160, 200, 210, 220, 239, and 240** 18 General Education Units as required for the AS Degree (CHDV 100 and 106 cannot be used to satisfy Social and Behavioral Science requirements)

All coursework must be completed with a grade of “C” or better.

PLEASE NOTE: Prior to applying for the Site Supervisor Permit, student must complete a Verification of Experience, documenting 350 days of work in an early childhood program of 3+ hours per day within 4 years including at least 100 days of supervising adults. (Permit applications can be obtained through the Child Development Department.)

Child Development Courses

CHDV 50 WORKING WITH YOUNG CHILDREN

Units: 3.0 | 48-54 hours lecture

(No prerequisite. Pass/No pass)

This survey course provides an introduction to early childhood education. Classroom instruction and practical experiences will include child development, child guidance, health and safety issues and curriculum exploration. This course will provide a foundation for continued course work in the field.

CHDV 100 CHILD GROWTH AND DEVELOPMENT

Units: 3.0 | **CSU, UC** | 48-54 hours lecture

(No prerequisite. Recommended preparation: Successful completion of ENGL 50 or eligibility for ENGL 101.0 is strongly advised)

The course examines the major physical, psychosocial, and cognitive/language developmental milestones for children, both typical and atypical, from conception through adolescence. There will be an emphasis on interactions between maturational processes and environmental factors. While studying developmental theory and investigative research methodologies, students will observe children, evaluate individual differences and analyze characteristics of development at various stages.

CHDV 106 CHILD, FAMILY AND COMMUNITY

Units: 3.0 | **CSU, UC** | 48-54 hours lecture

(No prerequisite. Recommended preparation: Successful completion of ENGL 50 or eligibility for ENGL 101.0 is strongly advised)

An examination of the developing child in a societal context focusing on the interrelationship of family, school and community, with emphasis on historical and socio-cultural factors. The processes of socialization and identity development will be highlighted, showing the importance of respectful, reciprocal relationships that support and empower families.

CHDV 110 PRINCIPLES AND PRACTICES OF TEACHING YOUNG CHILDREN

Units: 3.0 | **CSU** | 48-54 hours lecture

(No prerequisite. Recommended preparation: Successful completion of ENGL 50 or eligibility for ENGL 101.0 is strongly advised).

This course provides an introduction to the critical principles and practices of the field of early childhood education. Emphasis is placed on introducing students to interaction strategies that build meaningful relationships, provide for guidance and discipline, and support play and exploration. Students will consider developmental theory and its implications on interaction through play and relationships. The course will provide a brief overview of the field of early childhood education, and introduce students to developmentally appropriate practices of observation, assessment and curriculum planning.

CHDV 111 INFANT AND TODDLER CAREGIVING

Units: 3.0 | **CSU** | 48-54 hours lecture

(No prerequisite)

A study of the physical, perceptual, socio-emotional, cognitive development and behavior of the young child from birth to age three. Emphasis will be on the translation of theories of development to appropriate practices in the care giving environment.

CHDV 133 ART EXPERIENCES FOR YOUNG CHILDREN

Units: 3.0 | **CSU** | 48-54 hours lecture

(No prerequisite)

This curriculum course prepares students to support the young child's creative development. Students will select, develop, and present art materials and activities for young children. An understanding of appropriate developmental art experiences and the creative process will be stressed. Emphasis is placed on developing a classroom environment that promotes creative expression.

Child Development Courses

CHDV 134 LANGUAGE AND EARLY LITERACY DEVELOPMENT

Units: 3.0 **CSU** | 48-54 hours lecture

(No prerequisite)

This course will focus on the young child's language acquisition and early literacy development. Emphasis will be on introducing students to developmentally appropriate activities and practices, which will foster language and early literacy. The course will allow students to develop curriculum materials. It will satisfy the program/curriculum requirement for licensing and credentialing.

CHDV 137 THE CHILD WITH SPECIAL NEEDS

Units: 3.0 **CSU** | 48-54 hours lecture

(No prerequisite)

This course will provide the history of special education in the early childhood setting including an overview of legislation, assessment, curriculum development, and environmental issues. Students will identify the interrelationships of family, communities, and the early childhood educators.

CHDV 138 COOPERATIVE EDUCATION

See Cooperative Education listing (1-8 units). **CSU**

CHDV 141 BASICS OF SCHOOL-AGE CHILD CARE

Units: 3.0 **CSU** | 48-54 hours lecture

(No prerequisite)

An introduction to appropriate practices in school-aged programs and curriculum based upon knowledge of the social, emotional, physical, and cognitive development of the child ages six to twelve. Exploration of curriculum units that include creative art, music, and literature. Promoting positive behavior and dealing effectively with discipline issues will be covered along with an overview of organizing and administering school-aged programs.

CHDV 142 CHILD HEALTH, SAFETY, AND NUTRITION

Units: 3.0 **CSU** | 48-54 hours lecture

(No prerequisite. Recommended preparation: Successful completion of ENGL 50 or eligibility for ENGL 101.0 is strongly advised).

This course introduces the law, regulations, standards, policies and procedures of health, safety and nutrition which promote optimal health and positive attitudes toward wellness in the growing child at home and at school. Included will be identification and prevention of health problems; practical aspects of developing safe and healthy environments; and promoting good nutrition and food habits.

CHDV 144 MATH AND SCIENCE EXPERIENCES FOR YOUNG CHILDREN

Units: 2.0 **CSU** | 32-36 hours lecture

(No prerequisite)

This class will focus on the preschool child's acquisition of science and mathematical concepts. Emphasis will be on introducing students to developmentally appropriate activities and practices which will foster development in these areas. This course will also focus on the teacher's (adult) role in establishing an environment rich in opportunities for self-directed activities and will assist teachers in developing science and math materials and activities.

CHDV 145 MUSIC AND MOVEMENT EXPERIENCES FOR YOUNG CHILDREN

Units: 2.0 **CSU** | 32-36 hours lecture

(No prerequisite)

This course will introduce students to gross motor development in the early years and provide instruction on how to facilitate this development with movement activities. This course will also focus on musical activities and experiences through which children develop appropriate skills, concepts and attitudes. Students will select, develop and present music/movement activities leading to a comprehensive file of classroom activities to be implemented in one's own early childhood setting.

Child Development Courses

CHDV 148 SPECIAL TOPICS

See Special Topics listing (Variable units) [CSU](#)

CHDV 149 INDEPENDENT STUDY

See Independent Study listing (1-3 units) [CSU](#)

CHDV 150 INTRODUCTION TO CURRICULUM

Units: 3.0 [CSU](#) | 48-54 hours lecture

(No prerequisite. Recommended preparation: CHDV 100 and CHDV 110; successful completion of ENGL 50 or eligibility for ENGL 101 is strongly advised).

The study and application of curriculum design principles for early childhood educational programs. Course includes planning and evaluating developmentally appropriate activities and experiences that promote physical cognitive, creative, social and emotional growth in children. Planning a comprehensive unit of study is also included.

CHDV 160 OBSERVATION AND ASSESSMENT

Units: 3.0 [CSU](#) | 48-54 hours lecture

(Prerequisites: CHDV 100, CHDV 106, CHDV 110 and CHDV 150, minimum grade C.)

This course offers an in-depth study of current observation and assessment approaches to understand and articulate development in children birth through age 8. Guided by developmental theory, students will learn how observation and assessment influence the design of early childhood settings, understanding and guiding child behavior, curricular plans, communication with families, and support program quality. Student must be aware that homework for this course involves observing children in a variety of settings. TB clearance advisory.

CHDV 200 TEACHING IN A DIVERSE SOCIETY

Units: 3.0 [CSU](#) | 48-54 hours lecture

(Prerequisites: CHDV 100, CHDV 106, CHDV 110, CHDV 150, minimum grade C.)

This course is designed to help students become teachers who can explore and address diversity in ways that enhance the development of children in early childhood settings. It will address attitudes and behaviors toward others in the areas of culture, race, gender, age and abilities; the development of an anti-bias curriculum; the analysis of the classroom environment for culturally relevant and diverse materials and resources; as well as highlighting developmental issues and advocacy.

CHDV 210 PRACTICUM

Units: 4.0 [CSU](#) | 32-36 hours lecture and 96-108 hours laboratory

Prerequisites: CHDV 100, CHDV 106, CHDV 110, CHDV 150 minimum grade C. Recommended preparation: Successful completion of ENGL 50 or eligibility for ENGL 101.0

This course focuses on the integration and application of child development theory to facilitate learning among young children. Students will complete 108 lab hours of supervised field experience at the campus Child Development Center or with an approved mentor teacher in the community. Emphasis is placed on developing effective teaching strategies, play-oriented curriculum planning based upon observation and assessment, discipline and guidance techniques, cooperative relationships with staff and families, professional ethics and assessment of one's own professional competence. Current (within a year) medical verification of absence of tuberculosis (TB).

CHDV 220 THE MENTOR TEACHER/ADULT SUPERVISION

Units: 2.0 [CSU](#) | 32-36 hours lecture

(Prerequisites: CHDV 100, CHDV 106, CHDV 110, CHDV 142, CHDV 150, CHDV 160, CHDV 200 and CHDV 210, minimum grade C.)

A study of the methods and principles of supervising adults in early childhood programs. Emphasis is placed on the role of experienced classroom teachers/supervisors who function as Mentors to teachers while simultaneously addressing the needs of children, parents and other staff.

Child Development Courses

CHDV 239 ADMINISTRATION OF CHILDREN'S PROGRAMS I

Units: 3.0 **CSU** | 48-54 hours lecture

[Prerequisite: Completion of the State Department of Health required core courses (CHDV 106 and CHDV 100 or equivalent.) Completion of CTC Child Development Permit Matrix (CHDV 110, CHDV 142, CHDV 150, CHDV 160, CHDV 200, and CHDV 210) and Currently working in the field recommended.]

Introduction to the administration of early childhood programs. Covers program types, budget, management, regulations, laws, development and implementation of policies and procedures. Examines administrative tools, philosophies, and techniques needed to organize, open, and operate an early care and education program. This course is designed to fulfill three of the six semester units of administration required for the site supervisor permit.

CHDV 240 ADMINISTRATION OF CHILDREN'S PROGRAMS II

Units: 3.0 **CSU** | 48-54 hours lecture

[[Prerequisite: CHDV 100, CHDV 106, CHDV 110, CHDV 142, CHDV 150, CHDV 160, CHDV 200 and CHDV 210. Recommended Preparation: Currently working in the field of Early Childhood]

Effective strategies for personnel management and leadership in early care and education settings. Includes legal and ethical responsibilities, supervision techniques, professional development, and reflective practices for a diverse and inclusive early care and education program. This course is designed to fulfill three of the six semester units of administration required for the Site Supervisor Permit.

Commercial Art

Commercial Art is a course of study that uses art as the basis for practical and creative commercial applications. Such applications studied are the creation of corporate identify and product design. Commercial Art is instrumental in the creation of a wide variety of client's needs, ranging from print to web design.

Career Opportunities

The career potential produces such jobs as web designer, graphic designer, product designer, packaging designer, typographer and film production.

Faculty

Shuron Taylor

Commercial Art Courses

CART 71 SURVEY OF COMPUTER GRAPHICS STUDIO

Units: 4.0 | 48-54 hours lecture and 48-54 hours laboratory

(No prerequisites)

This course will introduce students to industry standard software packages used in visual communications. Students will be instructed on the basic use of draw, paint/photo, layout, multimedia, web and digital video applications. Topics covered include: Operating systems basics, drawing and painting on the computer, digitizing and editing sound and video and designing for interactivity.

CART 72 ADOBE ILLUSTRATOR

Units: 3.0 | 32-36 hours lecture and 48-54 hours laboratory

(No prerequisites)

This course covers the fundamental elements of Adobe Illustrator including, design, color theory, typography and appropriateness for specified uses in the graphics industry.

CART 133 DIGITAL IMAGING

Units: 3.0 | **CSU,UC** | 32-36 hours lecture and 48-54 hours laboratory

(No prerequisite. Recommended preparation ART 112 or ART 113).

This course covers the fundamental elements of Adobe Illustrator including, design, color theory, typography and appropriateness for specified uses in the graphics industry.

CART 134 THE ART OF WEB DESIGN

Units: 4.0 | **CSU** | 48-54 hours lecture and 48-54 hours laboratory

(No prerequisite)

An overview of most current industry standard software used for creating web pages. This course does not focus on HTML or scripting language but is focused on the development effective communications design. See cross-listing for **ART 134**.

CART 160 SURVEY OF A VISUAL COMMUNICATION

Units: 4.0 | **CSU** | 48-54 hours lecture and 48-54 hours laboratory

(No prerequisite)

An overview of Adobe Creative Suite. Students are given the opportunity to sample professional digital design tools while applying the fundamentals of design..

Communication Studies

Communication Studies is an expansive field which aims to:

- Analyze, understand, and facilitate effective expressions of organized thoughts
- Facilitates successful interaction with self, others, society and the world

Skills developed within this field are readily applicable in daily life. A bachelor's degree in Communication Studies offers pathways to careers in law, education, government, public relations and advertising, arts and entertainment, social and human services, international relations and negotiations. The Communication Studies Program features an advanced Communication Center, located on the 2nd floor of the Performing Arts Center, Room 54-213. The center is available to help with the development and delivery of oral presentations from research, outlining and delivery, to visual aids including PowerPoint presentations.

Career Opportunities

Administrator, Advertising, Counselor, Lobbyist, Marketing Specialist, Ministry, News Anchor, Public Information Officer
Publicity Manager, Speech Writer, Teacher

Faculty

Jacqueline Augustine-Carreira | Jennifer Fowlie | Gregory Jones
John Rude - Emeritus

Associate Degree

To earn an Associate in Arts degree for Transfer with a major in Communication Studies (31612), complete the required major courses and all other requirements specified on the following pages (i.e. 60 CSU transferable units, CSU GE or IGETC, etc.). For more information on the AA-T/AS-T degrees, meet with a counselor or www.adegreewithaguarantee.com

Program Learning Outcomes

A student receiving a degree or certificate in this field will be able to:

- Communicate ethically, responsibly, and effectively as local, national, international, and global citizens and leaders.
- Communicate competently in dyads, groups and organizations demonstrating an understanding of communication theories and principles.
- Monitor and model interpersonal communication competence demonstrating an ability to construct effective messages both oral and written in various formats, including the ability to interpret and evaluate feedback, for a variety of audiences.
- Possess skills to effectively compose and deliver formal and informal oral presentations to a variety of audiences in multiple contexts.

Transfer

For the most up-to-date information on these programs and others, visit www.assist.org. Please stop by the Transfer Center in Building 55 or make an appointment with a counselor if you have questions.

- **California State University, San Bernardino:** *Communication major*

Communication Studies

Communication Studies, AA-T (31612)

The Associate in Arts for Transfer Degree in Communication Studies provides an overview of the knowledge and skills students will demonstrate upon completion and conveys what students can expect as an outcome. The degree (1) encourages students to analyze, understand, and facilitate effective expression of organized thought, and (2) facilitates successful interaction with self, others, society and the world. Students are given the opportunity to transfer to a CSU with junior standing.

This degree is in full alignment with our existing Communication Studies Program and provides an additional option for those students desiring to transfer to a CSU Communication Studies Major.

Program Requirements: 18 units

Required Courses (3 units total)

CMST 109	Public Speaking	3.0
----------	-----------------	-----

Additional Courses

List A – (6 units total)

CMST 106	Interpersonal Communication	3.0
CMST 108	Group Discussion	3.0

List B – (6 units total)

CMST 105	Intercultural Communication	3.0
JOUR 108	Fundamentals of Journalism	4.0

List C – Select any ONE of the following courses (3 units total)

ANTH 102	Introduction to Cultural Anthropology	3.0
PSYC 101	Introductory Psychology	3.0
PSYC H101	Honors Introductory to Psychology	3.0
SOC 101	Introduction to Sociology	3.0
ENGL 102	Composition and Literature	3.0
ENGL H102	Honors Composition and Literature	3.0

A student wishing to pursue an AA-T/AS-T degree in the major listed on this page must ensure the CSU of their choice is accepting that similar major. Students completing an AA-T/AS-T degree are guaranteed admissions into a CSU campus given that a student fulfills the following:

- 1) 60 CSU transferable units;
 - 2) Completes the CSU General Education (GE) or IGETC General Education pattern;
 - 3) Completes the major requirements for the AA-T/AS-T;
 - 4) Maintains a transferable cumulative GPA of at least 2.0 (C or better);
 - 5) Completes the basic/Golden 4 GE requirements.
- For more information on the AA-T/AS-T degrees, meet with a counselor or visit www.adegreewithaguarantee.com

Communication Studies Courses

CMST 104 ARGUMENTATION AND ORAL DEBATE

Units Required: 3.0 *CSU, UC* | 48-54 hours lecture

(Recommended Preparation: ENGL 101 and CMST 109)

The study of argumentation within an oral debate setting. Treatment of the theories and practices of argument, both formal and informal. Emphasis on language as a tool of argument. Fallacies of reasoning, practical problem-solving situations, and systems of logic. Oral exercises including debates, extensive writing requirements including advocacy papers, and analysis of refutations of arguments.

CMST 105 INTERCULTURAL COMMUNICATION

Units Required: 3.0 *CSU, UC* | 48-54 hours lecture

(No prerequisites)

A course designed for the student to learn relevant intercultural communication elements, factors, and theories. Students will learn and be evaluated on: describing their cultural roots, creating an identity collage, defining worldview and cultural values, analyzing an intercultural encounter, describing an intercultural communication context, and exploring a specific intercultural topic. Students will demonstrate proficiency in the above through exams, individual and group presentations, and essays.

Communication Studies Courses

CMST 106 INTERPERSONAL COMMUNICATION

Units Required: 3.0 **CSU, UC** | 48-54 hours lecture

(No prerequisite) (UC credit limitation)

A course which examines human communication theory and principles across a variety of contexts. The course emphasizes analysis of communication variables as well as skill development and application.

CMST 107 FAMILY COMMUNICATION

Units Required: 3.0 **CSU** | 48-54 hours lecture

(No prerequisite) (UC credit limitation)

An introduction to human communication in the setting of the family. The goal is to help the student understand how, through communication, people develop, maintain, enhance, or destroy family relationships. Students will study variables and the process of communication as they affect the interaction of their families and develop insight that will make it possible to apply this knowledge.

CMST 108 GROUP DISCUSSION

Units Required: 3.0 **CSU, UC** | 48-54 hours lecture

(No prerequisite) (UC credit limitation)

Practical application of the processes involved in group discussion with an emphasis on problem solving and decision making from structured to unstructured situations. Principles are applicable to groups as those found in schools, businesses, professions, and the family. This course is designed to develop interpersonal skills for thoughtful participation in a democratic society.

CMST 109 PUBLIC SPEAKING

Units Required: 3.0 **CSU, UC** | 48-54 hours lecture

(No prerequisite) (UC credit limitation)

A course designed for the student to learn how to prepare, organize, and deliver public speeches. Students will learn and be evaluated on: constructing a speaking outline, analyzing an audience, adapting to the occasion, and using effective speaking delivery techniques. Students will demonstrate proficiency in the above through the delivery of speeches in the classroom.

CMST 110 INTRODUCTION TO MASS MEDIA

Units Required: 3.0 **CSU, UC** | 48-54 hours lecture

(No prerequisite)

This course introduces students to the influences and contributions of mass media in popular culture. It traces the historical development of each of the mass media, from earliest inventions to today's state-of-the-art digital technologies. This course surveys the impact of mass media on each of us as individuals and on American and world culture: where we might be going and what we can do about it. The course also examines how mass culture continually influences and shapes the media.

CMST 128 SPECIAL TOPICS

See Special Topics listing (Variable units). **CSU**

CMST 129 INDEPENDENT STUDY

See Independent Study listing (1-3 units). **CSU**

CMST 208LA JOURNALISM LAB A

Units Required: 3.0 **CSU, UC** | 48-54 hours lecture

(Prerequisite: ENGL 45. Co-requisite: CMST 208. Requisite Skill: Identify correct/incorrect usage of punctuation and grammar. Analyze topic, purpose, controlling idea/thesis, audience and support/evidence in pre-collegiate texts. Compose well-organized, developed, unified, and stylistically competent essays of 600 – 1000+ words).

This course introduces students to the influences and contributions of mass media in popular culture. It traces the historical development of each of the mass media, from earliest inventions to today's state-of-the-art digital technologies. This course surveys the impact of mass media on each of us as individuals and on American and world culture: where we might be going and what we can do about it. The course also examines how mass culture continually influences and shapes the media.

Computers

VVC has four departments that offer associate degrees and certificate programs for students interested in computers. See the specific listing for more information:

BUSINESS EDUCATION TECHNOLOGIES (BET) Programs in this department prepare students with professional office skills and procedures to function in high-tech business offices. Instruction is offered in most of the major software programs currently in use, such as Microsoft Word, Excel, PowerPoint, Access, etc. Certificates include Administrative Assistant, Medical Office Management, Legal Office Management, among others.

COMPUTER INFORMATION SCIENCE (CIS) CIS represents computing within both the Computer Science and Business disciplines. The computer science areas are oriented toward computer programming as used in writing programs and applications, and web authoring. The business areas include developing and managing database applications, networking, and operating systems. Transfer units, vocational (employment), and industry certification tracks are available.

COMPUTER INTEGRATED DESIGN AND GRAPHICS (CIDG) and (MERT) Computer Integrated Design Graphics and Media Arts consist of a three-pronged approach for fields within 3D Animation, Architecture & Engineering and GIS.

Digital Animation has become one of the fastest growing careers within the computer graphics industry, and prepares students to create video games, television commercials, architectural visualizations, animated logos, 3D website graphics or film-based special effects.

Computer Aided Design (CAD) prepares students to work in the fields of Architecture and Engineering as CAD drafters, architectural drafters, civil drafters, product designers, and more...

Geographic Information Systems (GIS) prepares students to work with all forms of county, state, federal and local government agencies related to emergency response and management of resources. Fire, police, sheriff, military and homeland security are just a few job areas for GIS technicians. GIS integrates hardware, software, link data (such as word processing documents, excel spreadsheets, drawings, photographs, maps, etc...) for displaying, analyzing and managing information and resources.

ELECTRONICS AND COMPUTER TECHNOLOGY (ELCT) Prepares students for high-tech careers in engineering and technology, computer technology, tele-communication, CISCO networking, cabling, PC Microsoft Certified Systems Engineer (MCSE), etc.

Students can transfer from VVC to a university and study the computing field in more depth, earning a Bachelor of Arts (B.A.) or a Bachelor of Science (B.S.) degree. Programs range from:

- “Pure” computing in such university departments as Computer Information Science and Computer Science (lots of math and science required), to
- Game Design, Web Programming, and Graphics Programming (math through calculus required), to
- Management Information Systems (MIS) within a Business major.

Visit www.assist.org to explore which universities offer programs in these fields, and to learn about what courses you can take at VVC before transferring.

Computer Information Science

The Computer Information Science (CIS) department provides training for those persons who plan to work within a technical, computer-centered environment. Because of the widespread use of computers in our society, employment opportunities are found in a multitude of different environments such as general business, communications industries, manufacturing, environmental engineering, education, medical technology, and banking and finance as well as computer information science. The program is specifically designed to provide the student with practical training which would be valuable and useful in the computer programming workplace.

Career Opportunities

Computer Operator, Computer Operations Management, Computer Training Specialist, Data Administrator
Data Control Clerk, Data Entry Operator, Documentation Clerk, Education Specialist, Electronic Graphics Artist
Information Center Specialist, Management Technical Assistant, Microcomputer Technical Support, Multimedia Specialist
Network Administrator, Network Specialist, Network Support Specialist, Production Control Clerk, Programmer
Programmer/Analyst, Programming Librarian, Quality Control Specialist, Systems Analyst, Technical Research Assistant
Technical Support Specialist, Technical Writer, User Support Specialist, Web Master, Web Page Development

Faculty

Ed Burg | Reiji Cass | Shane Thomas | Paul Toning

Degrees and Certificates Awarded

Associate in Science, Computer Information Science
Network Specialist Certificate
Productivity Software Specialist Certificate
Web Authoring Certificate

MySQL Database Developer Certificate
Programming I Certificate
UNIX Administrator Certificate

Program Learning Outcomes

A student receiving a degree or certificate in this field will be able to:

- Evaluate information technology systems.
- Communicate information technology concepts effectively with technical and non-technical audiences.
- Analyze and discuss technical problems related to environments where information technology is utilized.
- Implement logical computational solutions including documentation for an identified use case.
- Synthesize technology with environments that satisfy business, security, fault tolerance, legal, sustainability and other requirements.

Associate Degree

To earn an Associate in Science degree with a major in Computer Information Science (07547), complete a minimum of 18 units from any of the certificate requirements or from any Computer Information Science courses and meet all Victor Valley College graduation requirements. CIS 138 (Cooperative Education) may be used as Elective credit, but may not be used to fulfill major requirements.

Transfer

For the most up-to-date information on these programs and others, visit www.assist.org. Please stop by the Transfer Center in Building 55 or make an appointment with a counselor if you have questions.

Note: Typically, majors in Computer Science require the following courses taken prior to transfer: CHEM 201, CIS 201, 202; ECON 102; MATH 226, 227, 228, 231; PHYS 201, 203, 202, H204. An alternative to the CIS transfer major that appeals to many students is Administration, with an emphasis in CIS. See Business Administration.

- **California State University, San Bernardino:**
Computer Science major
Computer Systems major
Computer Engineering major
- **University of California, Riverside:**
Computer Science major
Computer Engineering major

Computer Information Science

MYSQL DATABASE DEVELOPER CERTIFICATE OF CAREER PREPARATION

The MySQL Database Developer Certificate is a high quality certification process that will provide evidence that a qualifying individual has skill in developing production relational MySQL database applications. By being certified, clients, customer, and employers are ensured that the database developer is competent and professional.

Units Required: 11.0

All of the following must be completed with a grade of "C" or better:

CIS 280	Fundamentals of Database Management Systems	3.0
CIS 96A	Structured Query Language	2.0
CIS 96B	Structured Query Language	2.0
CIS 91A	MySQL Admin A	2.0
CIS 91B	MySQL Admin B	2.0

NETWORK SPECIALIST CERTIFICATE OF CAREER PREPARATION

This certificate program prepares the student to begin a career in the computer networking field and working and administering a variety of popular network platforms including UNIX, Microsoft and Novell.

Units Required: 15.0-17.0

All of the following must be completed:

CIS 50	Computer Ethics	2.0
CIS 67	Fundamentals of Networking	3.0
CIS 90	Introduction to the UNIX Operating System	4.0

Choose one of these two options:

CIS 139	Windows XP For Power Users <i>or</i>	4.0
CIS 240A	Windows 2000 Enterprise Administration	4.0

Choose one of these two options:

CIS 261	UNIX System Administration	2.0
CIS 262	UNIX System Administration B	2.0

PROGRAMMING I CERTIFICATE OF ACHIEVEMENT (10796)

This certificate trains the student to become a programmer with some of the most popular programming such as C and Visual BASIC.

Units Required: 27.0

All of the following must be completed:

BADM 144	Business Communications	3.0
CIS 50	Computer Ethics	2.0
CIS 164	Computer Mathematics	3.0
CIS 101	Computer Literacy	4.0
CIS 105	Introduction to Systems Analysis	3.0
CIS 201	Programming Concepts and Methods I	4.0
CIS 202	Programming Concepts and Methods II	4.0

Group II - One of the following must be completed

CIS 210	Visual BASIC Programming in Visual Basic	4.0
CIS 206	Programming Java	4.0

Computer Information Science

PROGRAMMING II CERTIFICATE OF ACHIEVEMENT (07549)		
Completion of this certificate makes the student well versed in most popular programming languages and ready for business and highly technical software development.		
Units Required: 22.0		
<i>All of the following must be completed:</i>		
BADM 144	Business Communications	3.0
CIS 50	Computer Ethics	2.0
CIS 104	Object-oriented Software Analysis and Design	3.0
CIS 108	Assembly Language Programming	3.0
CIS 164	Computer Mathematics	3.0
CIS 203	C++ Module C	4.0
<i>Group II - One of the following must be completed</i>		
CIS 211	Advanced VB Programming A or B or C or	4.0
CIS 206	Programming Java or	4.0
CIS 206A	Java A and	2.0
CIS 206B	Java B	2.0
PRODUCTIVITY SOFTWARE SPECIALIST CERTIFICATE OF ACHIEVEMENT (07550)		
This certificate trains the student to become a well-rounded microcomputer user skilled in all the software that is common in business offices.		
Units Required: 25.0		
<i>Group I - All of the following must be completed:</i>		
CIS 101	Computer Literacy or	4.0
CIS 103	Foundations of Computer Technology	4.0
CIS 280	Fund D base Mgmt Systems	3.0
CIS 111	Multimedia Presentations	4.0
CIS 136	Introduction to Internet/WWW	2.0
CIS 139 B	Windows for Power Users	4.0
BET 112	Spreadsheet: Excel for Windows A/B/C	3.0
BADM 144	Business Communications	3.0
<i>Group II - 3 units of the following must be completed:</i>		
BET 104	Beginning Word Processing/Typing: Word for Windows A/B/C	3.0
BADM 106	Accounting on Software Applications Part A	2.0
BADM 107	Accounting on Software Applications Part B	2.0

Computer Information Science

UNIX ADMINISTRATOR CERTIFICATE OF CAREER PREPARATION

The UNIX Administrator Certificate is a high quality certification process that will provide evidence that a qualifying individual has skill in designing, implementing and maintaining UNIX and Linux based networks. By being certified, clients, customers, and employers are ensured that the UNIX administrator is well equipped to handle the day-to-day operations associated with a UNIX based network as well as the unforeseen problems that tend to arise in any network.

Units Required: 16.0

All of the following must be completed with a grade of "C" or better:

CIS 50	Computer Ethics	2.0
CIS 90	Introduction to the UNIX Operating System	4.0
CIS 261	UNIX System Administration	2.0
CIS 262	UNIX System Administration B	2.0

Group II: One of the following must be completed with a grade of "C" or better:

CIS 83	Programming in Python	4.0
CIS 94	PHP Programming	4.0

WEB AUTHORIZING CERTIFICATE OF CAREER PREPARATION

This certificate provides the student solid training in developing web pages.

Units Required: 15.0

All of the following must be completed:

CIS 111	Multimedia Presentations	4.0
CIS 136	Introduction to Internet	2.0
CIS 137	Introduction to HTML	3.0
CIS 205	Javascript	4.0
CIS 50	Computer Ethics	2.0

Computer Information Science Courses

CIS 50 COMPUTER ETHICS

Units Required: 2.0

32-36 hours lecture

(Recommended Preparation: Know how to use a personal computer: functions of mouse buttons and control of mouse movement (right click, left click, single click, double click, drag-and-drop, etc.), create, open and save files, install and run applications. Type about 30 WPM to keep up with class assignments.)

This course is an introduction to the theories and issues of ethical behavior as applied to the exigencies of a rapidly changing, information-oriented, computer-driven society. Topics include ethical history, philosophies, and issues at the responsibility level of both corporate business and the individual. Various ethical theories are introduced and discussed. Numerous current and past case histories are presented.

CIS 67 FUNDAMENTALS OF NETWORKING

Units Required: 3.0

32-36 hours lecture and 48-54 hours laboratory OR 96-108 hours individualized instruction

(No prerequisite. Recommended preparation: CIS 101)

This course presents a broad overview of the fundamentals of networking computers. It discusses in some detail the various network topologies, architectures, industrial standard, standards-defining organization, and the practical use of networks. This course is designed to prepare students to take the Network+ certification exam from CompTIA.

CIS 75 INTRODUCTION TO NETWORK SECURITY: SECURITY+

Units Required: 3.0

32-36 hours lecture and 48-54 hours laboratory OR 96-108 hours individualized instruction

(No prerequisite. Recommended preparation: CIS 67)

Presents security topics covering general security concepts, communications security, infrastructure security, basics of cryptography, operational and organizational security. Topics include hacking, viruses, cryptography, detection and prevention on both wired and wireless LANs.

Computer Information Science Courses

CIS 80 OPERATING SYSTEMS: MAC OS X

Units Required: 3.0 | 32-36 hours lecture and 48-54 hours laboratory

(No Prerequisite. Recommended preparation: Basic ability to use mouse and keyboard to navigate around a computer. Grade Option)

This course introduces the Mac OS X operating system and the applications and utilities that are included with the operating system. Topics include but are not limited to: the graphical user interface, OS X preferences, account management, spotlight searches, disk management, printing, networking, program installation and removal, system security, email, Internet access, display management, address book, calendar, instant messaging, QuickTime, music management, and support.

CIS 83 PROGRAMMING IN PYTHON

Units Required: 4.0 | 48-54 hours lecture and 48-54 hours laboratory

(No Prerequisite)

Python is a popular programming language that has taken a primary role in many companies including NASA, Google, Industrial Lights and Magic. Python uses an elegant syntax, making the programs easier to write and read, which also makes it an ideal language for beginning programmers. The foundation that students achieve can be applied to digital animation programs and game programming. No prior programming experience is assumed.

CIS 90 INTRODUCTION TO THE UNIX OPERATING SYSTEM

Units Required: 4.0 | 48-54 hours lecture and 48-54 hours laboratory

(No Prerequisite)

This course introduces the Unix and Linux operating systems. Topics include the history of Unix, commands and utilities, file system structure, shells, graphical user interfaces, networking, text editing and shell programming.

CIS 91A MYSQL ADMIN A

Units Required: 2.0 | 24-27 hours lecture and 24-27 hours laboratory

(No Prerequisite)

This course is designed to provide students with an introduction to the MySQL relational database management system. Students will learn how to design, install, configure and secure MySQL databases. The student should have prior experience with the fundamentals of databases.

CIS 91B MY SQL ADMIN B

Units Required: 2.0 | 24-27 hours lecture and 24-27 hours laboratory

(No Prerequisite)

This second course in MySQL database administration is designed to provide students with an advanced approach to current database administration issues in enterprise level databases. Topics include: transactions, multiple servers, replication, locking and administration interfaces.

CIS 94 PHP PROGRAMMING

Units Required: 4.0 | 48-54 hours lecture and 48-54 hours laboratory

(No Prerequisite. Recommended preparation: MATH 90)

This course is designed to provide students with an introduction to programming web-based applications using PHP. Students will learn how to design, code and implement dynamic web sites. This course will move the student from an understanding of XHTML to the development of powerful web applications that can be deployed over the Internet.

CIS 96A STRUCTURED QUERY LANGUAGE

Units Required: 2.0 | 24-27 hours lecture and 24-27 hours laboratory

(No Prerequisite)

This is the first of two courses in Structured Query Language using the MySQL database management system. Topics include concepts of relational databases and SQL, creating and using databases and performing queries.

Computer Information Science Courses

CIS 96B STRUCTURED QUERY LANGUAGE

Units Required: 2.0 | 24-27 hours lecture and 24-27 hours laboratory

(No Prerequisite)

This is the second course in Structured Query Language using the MySQL relational database management system. Topics include: Joins, IF/Case statements, indexing, batch operations and locking strategies.

CIS 101 COMPUTER LITERACY

Units Required: 4.0 | **CSU, UC** | 48-54 hours lecture and 48-54 hours laboratory

(No prerequisite. Recommended preparation: Mouse skills: know difference between, be able to perform, and know when to utilize: left click, right click, single click, double click, and drag and drop motion. Keyboarding skills: nominal typing speeds of about 30 words per minute (WPM))

This is a survey course which provides an overview of computer technology for multi-disciplinary majors. Using laboratory projects supported by the lecture, the student gains “hands- on” familiarity with different operating systems, word processors, spreadsheets, database management systems, programming, networks and the use of the Internet

CIS 104 OBJECT-ORIENTED ANALYSIS AND DESIGN

Units Required: 3.0 | **CSU** | 48-54 hours lecture

(No prerequisite. Recommended Preparation: CIS 101.)

This is a first course in the object-oriented modeling and design, a new way of thinking about problems using models organized around real-world concepts. The fundamental object-oriented construct is the object, which combines both data structure and behavior in a single entity. Object-oriented models are useful for understanding complex problems, communicating with application experts, modeling enterprises, preparing documentation, and designing programs and databases. This course is a prerequisite to all object-oriented programming language courses for it provides a requisite baseline working knowledge of unique object-oriented concepts and structure such as classes, objects and methods, encapsulation, inheritance, polymorphism and message abstraction, and static virtual methods.

CIS 105 INTRODUCTION TO SYSTEMS ANALYSIS

Units Required: 3.0 | **CSU** | 48-54 hours lecture

Offered Spring. (No prerequisite)

Introduces the three major skills required to perform effectively as a beginner in a systems analysis environment. Defines the specific steps in the determination of new systems’ requirements, system design, and the creative process used to select and make recommendations as to one or more solutions to system development.

CIS 111 MULTIMEDIA PRESENTATIONS

Units Required: 4.0 | **CSU** | 48-54 hours lecture and 48-54 hours laboratory

(No prerequisite)

Students gain experience in developing multimedia presentations while gaining an understanding of multimedia technologies. In acquiring “hands-on” experience in producing and presenting multimedia presentations, the student will also actively create audio files, full-motion, video clips, graphics, animation sequences, and the text used in the final production. Additional subjects which will be covered include the basic principles for effective communications, scripting, logical control of peripheral devices, and runtime packaging.

CIS 121 INTRODUCTION TO WEB ANIMATION

Units Required: 4.0 | **CSU** | 48-54 hours lecture and 48-54 hours laboratory

(No prerequisite. Recommended Preparation: Basic computer operational skills)

Captivating web user-interfaces and contents including animations are created using multiple tools. This is a beginning course on web animation. A number of modern tools will be introduced, such as Adobe Animate and Adobe Edge, etc.

Computer Information Science Courses

CIS 136 INTRODUCTION TO THE INTERNET

Units Required: 2.0 **CSU** | 24-27 hours lecture and 24-27 hours laboratory

(Prerequisite CID 101. Recommended preparation: Know how to use a personal computer: functions of mouse buttons and control of mouse movement (right click, left click, single click, double click, drag-and-drop, etc.), create, open and save files, install and run applications. Type about 30 WPM to keep up with class assignments.)

This course of instruction is designed for the student or savvy business person who wants to acquire the skills needed to effectively interact and utilize the resources of the Internet and its newer component, the World Wide Web (WWW). By completing this course, a student will become well versed in the understanding and using of browsers and viewers, FTP (File Transfer Protocol), news groups, e-mail, and chat/conversation utilities. They will also be made aware of some of the other concerns relating to using the Internet, such as privacy and security issues.

CIS 137 INTRODUCTION TO HTML

Units Required: 3.0 **CSU** | 32-36 hours lecture and 48-54 hours laboratory

(No prerequisite)

This course is designed for the student or business person who wants to acquire the skills needed to create a presence on the WWW (World Wide Web) in the form of a Web Page. The student will become conversant with HTML (Hypertext Mark-up Language) and CSS (Cascading Style Sheets) and be able to use HTML and CSS authoring (designing, implementing, and maintaining). The course will cover the creation of HTML and CSS documents.

CIS 138 COOPEATIVE EDUCATION

See Cooperative Education listing (1-8 units). **CSU**

CIS 139B WINDOWS FOR POWER USERS

Units Required: 4.0 **CSU** | 48-54 hours lecture and 48-54 hours laboratory

(No prerequisite. Recommended preparation: CIS 101)

Students will gain experience in installing, navigating, configuring, optimizing, troubleshooting, and customizing the current version of Windows. Additional subjects which will be covered include networking, disk management, diagnostics, using the Internet, and upcoming releases of Windows.

CIS 201 PROGRAMMING CONCEPTS AND METHODS I

Units Required: 3.0 **CSU, UC** | 48-54 hours lecture

(Corequisite CIS 201L. Recommended preparation CIS 101)

An introduction to programming using the C++ language. This course is appropriate for those wishing to learn the principles of computer programming and to gain some initial experience with C++.

CIS 201L PROGRAMMING CONCEPTS AND METHODS I LAB

Units Required: 1.0 | 48-54 hours laboratory

(Corequisite CIS 201)

This course is the Lab portion for CIS 201 Programming Concepts and Methods I. Students are required to enroll in CIS 201 and CIS 201L at the same time.

CIS 202 PROGRAMMING CONCEPTS AND METHODS II

Units Required: 3.0 **CSU, UC** | 48-54 hours lecture

(Prerequisites: CIS 201 minimum grade C. Corequisite: CIS 202L)

An introduction to programming using the C++ language. This course is required for the Computer Science ADT degree. The course is also appropriate for those wishing to learn the principles of computer programming and to gain some initial experience with C++.

CIS 202L PROGRAMMING CONCEPTS AND METHODS II LAB

Units Required: 1.0 | 48-54 hours laboratory

(Corequisite: CIS 202)

This course is the Lab portion for CIS 202 Programming Concepts and Methods II. Students are required to enroll in CIS 202 and CIS 202L at the same time.

Computer Information Science Courses

CIS 205 JAVASCRIPT

Units Required: 4.0 **CSU** | 48-54 hours lecture and 48-54 hours laboratory

(Prerequisites: CIS 201 minimum grade C)

JavaScript is the only client-side programming language for web pages on virtually all browsers. By incorporating JavaScript into HTML documents, web page contents become dynamic, customized, and interactive. When developing websites, JavaScript is a must in addition to server-side scripting, since many features are not supported on the server-side programming, such as mouseover and the likes. This course teaches students how to program the web pages using JavaScript including the Javascript language itself, the DOM (Document Object Model which is the structure upon which all web pages are based), the object based programming, and the browser event model as well as event driven programming; it also prepares students for further server-side web development. ented features in depth. Subject matter includes: designing and implementing classes, abstract data types, overloading operators, inheritance, and polymorphism.

CIS 206 PROGRAMMING JAVA

Units Required: 4.0 **CSU** | 48-54 hours lecture and 48-54 hours laboratory

(No prerequisite)

This is a course for programming in Java. The course will cover the basics of the Java programming language and object oriented programming method. Some of the more advanced topics such as applets programming data structure implementation in Java will also be covered.

CIS 208 COMPUTER ARCHITECTURE AND ORGANIZATION

Units Required: 3.0 **CSU, UC** | 32-36 hours lecture and 48-54 hours laboratory

(No prerequisite)

Designed to train students to understand microcomputer systems low level (hardware) organizations and architecture through assembly language programming. (Formerly CIS 108)

CIS 210 PROGRAMMING IN VISUAL BASIC

Units Required: 4.0 **CSU** | 48-54 hours lecture and 48-54 hours laboratory

(No prerequisite)

Visual Basic is the world's most popular programming language used for application development. This course is based on the latest VB.NET. VB is an object-oriented programming language suitable not only for Windows applications, but also for Web applications. While retaining its advantages in ease of learning, efficiency at developing sophisticated applications, VB.NET has now added an array of powerful features such as Web forms, mobile controls, support for XML, full compatibility with other languages (such as C#, Visual C++, Cobol, NET), etc. Students will learn all the programming basics using VB.NET, as well as being exposed to topics such as Object-Oriented programming, Database programming, and Web programming.

CIS 240A WINDOWS ENTERPRISE ADMINISTRATION

Units Required: 4.0 **CSU** | 48-54 hours lecture and 48-54 hours laboratory

(Prerequisite: CIS 101 or equivalent)

An introduction to operating system design and operation using Windows Enterprise version in a client/server environment. Topics include: the design and philosophy of the Windows operating system, the differences between various Windows versions, user issues in Windows such as using Windows command prompt vs. the Graphical User Interface, and basic installation issues. Emphasis will be given to comparing the differences in administering Windows enterprise to Windows Professional. Hands-on experience will be stressed.

CIS 241 MICROSOFT WINDOWS SERVER ADMINISTRATION *(Formerly CIS 240B)*

Units Required: 4.0 **CSU** | 48-54 hours lecture and 48-54 hours laboratory

(Prerequisites: CIS 139 or 240A or equivalent and CIS 101 and CIS 67; minimum grade C)

Covers administration of the current version of Windows Server on a network. Topics include: installation, user management, security, performance issues, Active Directory, Group Policies, network printing, the system registry, backups, and setting up applications.

Computer Information Science Courses

CIS 261 UNIX SYSTEM ADMINISTRATION

Units Required: 4.0 **CSU** | 48-54 hours lecture and 48-54 hours laboratory

(Prerequisite: CIS 90 with a grade of 'C' or better)

UNIX system administrators are responsible for the operation of UNIX systems—the most common server platform on the Internet. Learn how to setup, manage, and maintain UNIX systems. Topics include: the role of the system administrator in an organization, UNIX variants, installation, booting and shutting down, backups, managing users.

CIS 262 UNIX SYSTEM ADMINISTRATION B

Units Required: 2.0 **CSU** | 16-18 hours lecture and 48-54 hours laboratory

(No prerequisite)

This second UNIX system administration course covers advanced UNIX administration topics, including system security, setting up and managing Internet services such as Hypertext Transfer Protocol, File Transfer Protocol, and e-mail.

CIS 264 DISCRETE STRUCTURES

Units Required: 3.0 **CSU, UC** | 48-54 hours lecture

(Prerequisite: MATH 90)

This course will cover logic in computer science as a tool to establish truth through various techniques of proof. The goal of this course is for us to learn formal logic as a theoretical foundation and its application to topics in discrete mathematics and computer science..

CIS 280 FUNDAMENTALS OF DATABASE MANAGEMENT SYSTEMS

Units Required: 3.0 **CSU** | 32-36 hours lecture and 48-54 hours laboratory

(No prerequisite)

This course provides an in-depth knowledge of several different database management systems (DBMS) and an understanding of the basic relational, network, or hierarchical database structures which they use. Issues of privacy, security, protection, integrity, redundancy, distributed database concepts, data manipulation and query languages are covered. Students will learn how these concepts and facilities are implemented on common microcomputer-based DBMS products and will learn “hands-on” how these common features are implemented in a variety of such products.

Computer Integrated Design and Graphics

The Computer Integrated Design and Graphics (CIDG) program at Victor Valley College is growing to keep pace with our High Desert community. We have many new and exciting courses, programs, and certificates to meet the needs of our students. Our focus is on designing courses and certificate programs that will provide students with the knowledge and skills to secure a job in a career field that has unlimited potential.

The cornerstone of the department remains our Computer Aided Drafting & Design (CADD) program. There are five new certificates that have been designed to meet the needs of students new to the field of CADD and those experienced professionals looking to upgrade their software knowledge. A core certificate is offered for students with a limited knowledge of drafting, mathematics and blueprint reading. (Drafting Technician I) Two entry-level certificates are offered in the areas of CADD and Computer Animation. We have also included two specialized certificates in the areas of Architectural CADD.

Digital Animation has become one of the fastest growing careers within the computer graphics industry. The CIDG Department's 3D Animation courses are designed for individuals seeking training in advanced techniques and procedures currently used in today's 3D production workplace. Designed for both beginning and advanced students, the department's 3D animation curriculum is geared toward individuals interested in creating video games, television commercials, product or architectural visualizations, animated logos, 3D website motion graphics or film-based special effects. Learning essential principles and techniques for creating professional quality work, students are introduced to problem-solving situations similar to those encountered in a real world production environment. Students successfully completing the program's courses possess entry-level skills that apply to a wide variety of career opportunities (see below). Several program certificates are currently offered. The primary software package used in all 3D Animation courses in the CIDG Department is Autodesk 3ds Max.

3D Animation classes are also offered through the college's Media Arts Department. Please see the Media Arts (MERT) section of the catalog for the courses the department currently offers.

Career Opportunities

CAD Careers: Architect, Architectural Drafter, CAD Management, CAD Operator, Cabinet Shop Detailer, Civil Drafter, Computer Animator, Community College Instructor, Construction Technician, Desk-Top Publisher, Electrical Drafter, Electronics Drafter, GIS Technician, Graphics Designer, Interior Designer, Landscape Architect, Landscape Designer, Mapping Specialist, Mechanical Drafter, Public Works Technician, Rendering Specialist, Steel Fabricator Drafter, Structural Drafter, Technical Illustrator

3D Animation Careers: Modeler, Texture Artist/Painter, Lighting Specialist, Character Designer, Character Animator, Special F/X Animator, Environment Designer, Game Level Designer, Architectural Animator, Mechanical Design Animator, Medical Visualization Artist, Courtroom Visualization Artist, Web Graphics Animator, Storyboard Artist, Layout Artist, Graphic Designer, Composer

Faculty

Claude Oliver | Steve Nelle

Degrees and Certificates Awarded

Associate in Science, CIDG

CADD I Technician Certificate

Digital Animation Technician I Certificate 3ds Max

Digital Animation Artist 3ds Max Certificate

Drafting Technician I Certificate

Architectural CADD Technician I Certificate

Expanded Animation Technician 3ds Max Certificate

Digital Filmmaker Certificate

Program Learning Outcomes

For Cad & Drafting

- To create compelling two and three dimensional project that meet current industry standards
- To discuss the key components of design, process, layout, and function as it relates to the real work

For Animation

- To discuss the key components of design, process, layout, and function as it relates to the real world
- To develop scene aesthetics that emphasizes creativity and storytelling

Computer Integrated Design and Graphics

Associate Degree

To earn an Associate in Science degree with a major in CIDG, complete a minimum of 18 units from any of the certificate requirements or from any CIDG courses, and meet all Victor Valley College graduation requirements. CIDG 138 may be used as elective credit but may not be used to fulfill major requirements.

Transfer

Not a transfer major. Most CIDG courses transfer as electives or fulfill subject credit requirements. Some CIDG courses fulfill lower division requirements for a related major. Students in this program sometimes choose to pursue a bachelor's degree in Architecture or Engineering. See Architecture and Engineering for transfer requirements for these majors.

For Additional Animation classes see Media Arts

DRAFTING TECHNICIAN I CERTIFICATE OF CAREER PREPARATION		
The Drafting Technician I certificate prepares students to work in the fields of architecture, engineering, and drafting as a drafter. Students will have a working knowledge of mechanical and architectural drawing. Students will understand the concepts of lineweights, lettering, orthographic projection, and sketching.		
Units Required: 15-17.00		
CIDG 101	Introduction to Drafting	3.0
CIDG 103	Blueprint Reading for Construction	3.0
CT 105	Technical Sketching	3.0
CT 107	Technical Mathematics <i>or</i>	3.0
MATH 90	Intermediate Algebra	4.0
CT 108	Advanced Technical Math <i>or</i>	3.0
MATH 104	Trigonometry	4.0
ARCHITECTURAL CADD (COMPUTER AIDED DESIGN AND DRAFTING) TECHNICIAN I CERTIFICATE OF CAREER PREPARATION		
The Architectural CADD (Computer-Aided-Drafting and Design) Technician I certificate prepares students to work in the field of Architecture as a CADD drafter. Students will be knowledgeable in Revit and AutoCAD software and understand the basics of producing construction documents using both Revit and AutoCAD. Students will have a conceptual knowledge of 3-D modeling and rendering. Students will also be able to perform print reading tasks as they relate to commercial and residential architecture.		
Units Required: 12.0		
<i>All of the following must be completed.</i>		
CIDG 103	Blueprint Reading for Construction	3.0
CIDG 108	Architectural Presentation	3.0
CIDG 110	Two-dimensional Autocad	3.0
CIDG 250	Using REVIT for Architectural CAD	3.0
CADD (COMPUTER AIDED DESIGN AND DRAFTING) TECHNICIAN I CERTIFICATE OF CAREER PREPARATION		
The Drafting Technician I certificate prepares students to work in the fields of Architecture, Engineering, and Drafting as a drafter. Students will have a working knowledge of mechanical and architectural drawing.		
Units Required: 9.0		
<i>All of the following must be completed.</i>		
CIDG 110	Two Dimensional AutoCAD	3.0
CIDG 210	Advanced Two Dimensional AutoCAD	3.0
CIDG 120	3-D CADD Using Inventor	3.0

Computer Integrated Design and Graphics

DIGITAL ANIMATION TECHNICIAN I 3DS MAX CERTIFICATE OF CAREER PREPARATION

The 3ds Max certificate is designed to offer students a detailed look at one of the Animation industry's premier 3D packages. The courses taken to complete the certificate provide students an opportunity to learn a variety of topics, including how to model 3D objects, how to create realistic textures and materials, the art of camera and lighting techniques, and a variety of keyframing solutions to bring their ideas to life. In addition to completing both individual and group projects, students also delve into the traditional principles of animation that serve to heighten the level of realism and believability of an individual's work.

Units Required: 9.0

All of the following must be completed.

CIDG 160	3ds Max Fundamentals	3.0
CIDG 260	3ds Max Advanced Modeling and Materials	3.0
CIDG 261	3ds Max Character Animation and Advanced Keyframing Techniques	3.0

DIGITAL FILMMAKER CERTIFICATE OF CAREER PREPARATION

The Digital Filmmaker certificate is designed to teach students to look at films as an art form, rather than as entertainment. The courses taken to complete the certificate provide students invites to explore the expressive and communicative nature of film while also examining the process by which films are made. The courses cover topics such as camera operation, lighting, composition, script-writing, storyboarding, audio, editing, compositing, and practical film making techniques. Individual projects will give students the opportunity to hone their personal skillset, while large group and class projects will teach students to work collaboratively, a necessary skill in this demanding industry.

Units Required: 6.0

All of the following must be completed with a grade of "C" or better.

ART 104	Film as an Art Form	3.0
MERT 74	Digital Video Production	3.0

EXPANDED ANIMATION TECHNICIAN 3DS MAX CERTIFICATE OF CAREER PREPARATION

This certificate crosses over all the software taught under the CIDG and MERT programs, any student who achieves this certificate has gone through the program and successfully completed the demo reel project, they have learned to work in a large complex environment and complete assigned tasks on an individual and group level. The student has learned the functions required to work on a large structured project in which their skill sets in a CG environment are tested and judged by peers in the class and the instructor when the project is finalized.

Units Required: 12.0

All of the following must be completed with a grade of "C" or better.

CIDG 160	3ds Max Fundamentals	3.0
CIDG 260	3ds Max Advanced Modeling and Materials	3.0
CIDG 261	3ds Max Character Animation and Advanced Keyframing Techniques	3.0
MERT 53	Advanced Animation/Demo Reels	3.0

Computer Integrated Design and Graphics

DIGITAL ANIMATION ARTIST 3DS MAX CERTIFICATE OF CAREER PREPARATION

The Digital Animation Artist certificate is designed to expand an individual's expertise in 3D Animation by requiring additional training in traditional art principles and techniques. Employers many times view an animator who possesses the ability to both draw and more thoroughly understand concepts and practices specific to traditional art painting as more well-rounded and work-ready. By earning the Digital Animation Artist certificate, students will better position themselves for employment opportunities in this fast-paced and competitive field. An Adobe Photoshop course specific to 3D Animation applications is also required to earn a certificate.

Units Required: 15.0

Group I: All of the following must be completed:

CIDG 160	3ds Max Fundamentals	3.0
CIDG 260	3ds Max Adv Modeling and Materials	3.0
CIDG 261	3ds Max Character Animation and Advanced Keyframing Techniques	3.0
MERT 56	Photoshop for Animators	3.0

Group I: All of the following must be completed:

ART 101	Survey of Art History	3.0
ART 104	Film As an Art Form	3.0
ART 112	Design I	3.0
ART 113	Design II	3.0
ART 122	Life Drawing I	3.0
ART 124	Anatomy of Life Drawing	3.0
ART 125	Drawing I	3.0
ART 141	Sculpture I	3.0

Computer Integrated Design and Graphics Courses

CIDG 50 DRAFTING LABORATORY

Units Required: 1-4.0

48-54 hours of laboratory required for each unit

(No prerequisite.)

Drafting laboratory provides the additional time, equipment, and instruction necessary to develop problem solving, board or AutoCAD skills at each individual's own pace.

CIDG 65 3DS MAX ADVANCED EFFECTS AND COMPOSITING

Units Required: 3.0

32-36 hours lecture and 48-54 hours laboratory

(Prerequisite: CIDG 160. Grade Option)

Students will learn advanced concepts and procedures required for creating high quality 3D special effects. Topics will include particle systems, Space Warps, and MassFX. Rendering techniques incorporating depth of field, motion blur, and anti-aliasing filters will also be discussed. Alpha channel compositing techniques will be addressed in detail. Students will also explore and analyze relevant issues pertaining to the computer animation industry.

CIDG 80 GEOGRAPHICAL INFORMATION SYSTEMS FOR EMERGENCY MANAGEMENT AND GOVERNMENT SERVICES I

Units Required: 3.0

32-36 hours lecture and 48-54 hours laboratory

(No prerequisite)

This course provides an in depth introduction to: (a) why GIS matters and (b) the role of Geographic Information Systems (GIS) in the modern economy. This course combines three learning methods aimed at helping students to master the use of the software: (a) Class lecture that reinforces the conceptual understanding of theory behind various tasks performed in ArcGIS. (b) Detailed step-by-step instructor lead exercise that exposes students to various workflows and specific ArcGIS Tools, (c) Exercise assignment designed for students to perform specific GIS tasks. Specific topics taught will include an understanding of GIS terminology, raster and vector data structures, data sources and accuracy, methods of data acquisition, conversion and input, requirements for metadata, working with spatial data databases (map features and attribute tables), and spatial analysis (map overlays, buffers, networks).

CIDG 81 GEOGRAPHICAL INFORMATION SYSTEMS FOR EMERGENCY MANAGEMENT AND GOVERNMENT SERVICES II

Units Required: 3.0

32-36 hours lecture and 48-54 hours laboratory

(Prerequisite: CIDG 80)

This course introduces students to the current roles of GIS in support of emergency management activities at both local and federal levels. These roles are considered at each of the four stages of crisis management namely mitigation, preparation, response, and recovery. The course will introduce students to the some of the basic maps requested during emergency including Incident Action Plan maps (IAP), Briefing maps, damage prediction maps, basic census demographics, transportation maps, aerial operation maps, situational plan maps and progression maps. This course introduces students to the various GIS techniques deployed to help government and businesses to operate in the constantly changing environment. The course will consist of two parts: lecture/discussion and a lab. The lecture/discussion period will cover methodology, theory, concepts, and application of GIS in emergency management and governments (local and federal).

CIDG 95 INTRODUCTION TO SOLIDWORKS

Units Required: 3.0

CSU

32-36 hours lecture and 48-54 hours laboratory

(No prerequisite)

This course is designed to introduce the student to three-dimensional parametric solid modeling with SolidWorks. Students will begin with basic parametric solid modeling techniques and advance into complex assemblies requiring animation. CIDG 101

CIDG 101 INTRODUCTION TO DRAFTING

Units Required: 3.0

CSU

32-36 hours lecture and 48-54 hours laboratory

(No prerequisite)

This survey course will explore the basic techniques used in the drafting industry. The course will emphasize proper use of instruments, lettering, and line quality. Course includes work in the fields of architectural, mechanical, and computer aided drafting.

Computer Integrated Design and Graphics Courses

CIDG 103 BLUEPRINT READING FOR CONSTRUCTION

Units Required: 3.0 **CSU** | 48-54 hours lecture

(No prerequisite)

A course designed to develop skills necessary to interpret both residential and commercial construction drawings and blueprints.

CIDG 108 ARCHITECTURAL PRESENTATION

Units Required: 3.0 **CSU** | 32-36 hours lecture and 48-54 hours laboratory

(No prerequisite. Grade Option)

A study of two common architectural presentation techniques: model making and illustration. Students will develop skill in creating architectural models using paper, mat board, wood, plastic, and styrene foam. The illustration portion of this course will include work with perspectives in pencil, watercolor, and airbrush.

CIDG 110 TWO DIMENSIONAL AUTOCAD

Units Required: 3.0 **CSU** | 32-36 hours lecture and 48-54 hours laboratory

(No prerequisite. Grade Option)

An introduction to the AutoCAD program including all necessary basic commands required for computer aided drafting. Students will master drawing setup, common draw, edit and viewing commands and plotting. Lectures and exercises are designed to provide a comprehensive knowledge of all basic computer drafting functions.

CIDG 120 3-D CADD USING INVENTOR

Units Required: 3.0 **CSU** | 32-36 hours lecture and 48-54 hours laboratory

(No prerequisite)

Solid Modeling and Three Dimensional CADD will introduce students to a new auto desk software package entitled INVENTOR. Students will understand the concepts involved in Parametric Modeling. Students will begin by constructing basic shapes and proceed to building intelligent solid models and create multi-view drawings. Assembly drawings, section views, auxiliary views, sheet metal drawings, and details will also be produced. Students will develop their drafting and computer skills through drawings and projects that emphasize teamwork and the design process. Students will also learn various hardware, software and peripheral components related to operating a CADD station.

CIDG 138 COOPERATIVE EDUCATION

See Cooperative Education listing (1-8 units). **CSU**

CIDG 160 3DS MAX FUNDAMENTALS

Units Required: 3.0 **CSU** | 32-36 hours lecture and 48-54 hours laboratory

(No prerequisite. Grade Option)

Students will learn the basics of 3D modeling, how to create and apply realistic textures, lighting principles and techniques, camera types and their appropriate usage, and fundamental keyframing procedures. Other topics to be covered include storyboards, the traditional principles of animation, current industry trends and issues pertaining to rendering output for different mediums (film, video, Internet, etc.).

CIDG 210 ADVANCED TWO DIMENSIONAL AUTOCAD

Units Required: 3.0 **CSU** | 32-36 hours lecture and 48-54 hours laboratory

(No prerequisite)

Recommended Preparation: CIDG 110. A working knowledge of AutoCAD is necessary. This course will explore the more advanced two-dimensional features of the AutoCAD program including entity filters, at-tributes, external reference files, paper space, and slide presentations. Projects include sectional description of compound shapes and developments.

Computer Integrated Design and Graphics Courses

CIDG 250 USING REVIT FOR ARCHITECTURAL CAD

Units Required: 3.0 **CSU** | 32-36 hours lecture and 48-54 hours laboratory

(No prerequisite. Grade Option)

This course is designed to develop computer drafting skills necessary to produce residential working and presentation drawings using the REVIT software. Design principles will be explored through the use of the AutoCAD/AutoDESK Architectural Desktop program.

CIDG 260 3DS MAX ADVANCED MODELING AND MATERIALS

Units Required: 3.0 **CSU** | 32-36 hours lecture and 48-54 hours laboratory

(Prerequisite: CIDG 160)

Students will learn the more advanced modeling features of 3ds Max. Complex aspects of building materials and textures will be covered in depth. The course will culminate with students being introduced to the video game environment, having the opportunity create their own game level. The course will prepare students for work in the entertainment, commercial, and computer gaming industries.

CIDG 261 3DS MAX CHARACTER ANIMATION AND ADVANCED KEYFRAMING TECHNIQUES

Units Required: 3.0 **CSU** | 32-36 hours lecture and 48-54 hours laboratory

(Prerequisite: CIDG 160. Grade Option)

Students will learn advanced animation techniques including editing keyframes through Track View, animating with controllers and constraints, wiring parameters, and using hierarchies. Character animation will be addressed in depth. Character Studio and Bones will be utilized to build skeletal systems for both characters and creatures. The course will prepare students for work in the entertainment, commercial, and computer gaming industries.

Construction and Manufacturing Technology

The Construction Technology program provides preparation for a wide variety of positions in the construction field as a contractor, supervisor, building inspector or tradesperson. The program offers the opportunity to be self-employed and the pride and satisfaction of creating and building with your own hands.

Certificates of achievement can be earned in Construction Management, Building Construction, Building Inspection, Public Works, HVAC/R, Plumbing and Electrical & Residential Maintenance. The Associate in Science degree is awarded upon completion of 18 semester units in Construction Technology courses and the required general education and elective courses. Transfer to the CSU system for a bachelor's degree in Industrial Technology is available.

Career Opportunities

Building Inspector, Cabinetmaker, Construction Accountant, Construction Estimator, Construction Insurance Agent, Construction Law Specialist, Construction Salesperson, Construction Supervisor, Contractor, Cement Mason, Civil Engineer, Electrician, Environmental Construction Specialist, Financial Specialist, Framing, Grader, Hazardous Materials Specialist, Heating and Air Conditioning, Engineer, Job Foreman, Materials Engineer, Millwright, Metal Building Specialist, Painter, Plumber, Plasterer, Project Supervisor, Public Works Technician, Purchasing Agent, Safety Specialist, Soils Engineer, Surveyor, Tinsmith, Waste Water Specialist, Water Distribution System Specialist, Workers Comp Specialist

Associate Degree

To earn an Associate in Science degree with a major in Construction Technology a minimum of 22.5 units must be completed as specified on the following page. and the student must meet all Victor Valley College graduation requirements.

Transfer

Some Construction Technology courses transfer to CSU as electives or may fulfill subject credit requirements. Some students in this program choose to pursue a bachelor's degree in Architecture or Engineering. See Architecture and Engineering for transfer requirements for these majors.

CSU Stanislaus, located in the Central Valley not far from the San Francisco Bay area, offers a B.S. degree in Applied Studies Leadership, to which up to 30 units of VVC's Construction and Manufacturing Technology courses can be applied. Prerequisites: BADM 101, CIS 101, ECON 102, and MATH 120, plus complete the remaining CSU General Education-Breadth requirements (you can use ECON 102 and MATH 120 for both). Visit www.assist.org for the most up-to-date information.

Degrees and Certificates Awarded

Associate in Science, Construction Technology
Construction Technology Certificate
Basic Heating, Ventilation and Air Conditioning/Refrigeration Certificate
Basic Residential Maintenance Technician Certificate
Basic Woodworking Certificate
Building Inspector Certificate
Basic Machining Certificate of Career Preparation

Construction Management Certificate
Basic Electrician Technician Certificate
Building Construction Certificate
Plumbing Technician Certificate
Renewable Energy Certificate
Public Works Certificate

Program Learning Outcomes

A student receiving a degree or certificate in this field will be able to:

- Identify procedures and strategies to minimize safety hazards and environmental impact associated with construction and manufacturing projects.
- Properly perform construction and manufacturing trade work following standard industry practice.
- Describe building code and legal requirements associated with construction and manufacturing projects.

Construction and Manufacturing Technology

CONSTRUCTION TECHNOLOGY, A.S. (07564)

To earn an Associate in Science degree with a major in Construction Technology a minimum of 22.5 units must be completed from the following list of departmental classes and the student must meet all Victor Valley College graduation requirements.

Units Required: 22.5

Group I - All of the following must be completed:

CT 101	Careers in Construction and Manufacturing	1.5
CT 103	Construction Management	3.0
CT 104	Construction Law	3.0
CT 106	Materials of Construction	3.0
CT 110	Building Codes and Zoning	3.0
CT 116	Construction Safety	2.0
CT 131	Microcomputers in Construction	4.0

Group II - One of the following must be completed:

CT 105	Technical Sketching	3.0
CT 107	Technical Math	3.0
CT 108	Advanced Technical Math	3.0
CIDG 103	Blueprint Reading for Construction	3.0

CONSTRUCTION TECHNOLOGY CERTIFICATE

Provides the core knowledge and skills that are common and fundamental to success in a wide variety of construction trades.

Units Required: 19.5

Group I - All of the following must be completed:

CT 101	Careers in Construction and Manufacturing	1.5
CT 105	Technical Sketching	3.0
CT 106	Materials of Construction	3.0
CT 116	Construction Safety	2.0
CT 131	Microcomputers in Construction	4.0
CIDG 103	Blueprint Reading for Construction	3.0

Group II - One of the following must be completed:

CT 107	Technical Math	3.0
CT 108	Advanced Technical Math	3.0

Construction and Manufacturing Technology

BUILDING CONSTRUCTION CERTIFICATE OF ACHIEVEMENT (10799)

Provides the basic knowledge and skills necessary for job opportunities in a wide variety of specific construction trades including masonry, finish carpentry, framing, construction sales, drywall, painting, plumbing, electrical, roofing, heating, ventilation and air conditioning, and surveying.

Units Required: 18.0 *Students must complete their Construction Technology Certificate plus all the following:*

Group I - All of the following must be completed:

CT 132	Construction Estimation	3.0
--------	-------------------------	-----

Group II - Two of the following must be completed:

CT 120A	Electrical Wiring	4.0
CT 120B	Commercial Wiring	4.0
CT 121	Finish Carpentry	4.0
CT 122A	Heating and Air Conditioning	4.0
CT 122B	Commercial Refrigeration	4.0
CT 123	Surveying	4.0
CT 124	Plumbing	4.0
CT 125	Concrete and Masonry Construction	4.0
CT 127	Framing	4.0

Group III - 7 units of the following must be completed:

CT 60A	Construction Laboratory	1-4
CT 60B	Construction Laboratory	1-4
CT 60C	Construction Laboratory	1-4
CT 60D	Construction Laboratory	1-4
CT 148	Special Topics	1-6

BUILDING INSPECTION CERTIFICATE OF ACHIEVEMENT (07565)

Provides a thorough background and skill level for employment in the building inspection field. This certificate prepares the student for employment in City and County Building and Safety departments as a private industry or corporate job site inspector.

Units Required: 21.0 *Students must complete their Construction Technology Certificate plus all the following:*

CT 110	Building Codes and Zoning	3.0
CT 111A	International Building Code I	3.0
CT 111B	International Building Code II	3.0
CT 112	Uniform Mechanical Code	3.0
CT 113	Uniform Plumbing Code	3.0
CT 114	National Electrical Code	3.0
CT 115	Technical Office Procedures and Field Inspection	3.0

Construction and Manufacturing Technology

CONSTRUCTION MANAGEMENT CERTIFICATE OF ACHIEVEMENT (07566)

Provides the skills and background necessary for employment as a contractor, construction business manager, construction supervisor, or foreman when linked with appropriate, trade-specific knowledge.

Units Required: 18.0-19.0 | *Students must complete their Construction Technology Certificate plus all the following:*

Group I - All of the following must be completed:

CT 103	Construction Management	3.0
CT 104	Construction Law	3.0
CT 109	Construction Financing	3.0
CT 110	Building Codes and Zoning	3.0
CT 132	Construction Estimation	3.0

Group II - One of the following must be completed:

BADM 101	Financial Accounting	4.0
BADM 103	Financial Accounting Fundamentals	3.0

BASIC ELECTRICIAN TECHNICIAN CERTIFICATE OF CAREER PREPARATION

This certificate provides the necessary knowledge and skill level required for employment in the electrical industry.

Units Required: 16.0 | *Students must complete their Construction Technology Certificate plus all the following:*

Group I - All of the following must be completed:

CT 114	National Electrical Code	3.0
CT 116	Construction Safety	2.0
CT 120A	Electrical Wiring	4.0
CT 120B	Commercial Wiring	4.0

Group II - One of the following must be completed:

CT 107	Technical Math	3.0
CT 108	Advanced Technical Math	3.0

BASIC HEATING, VENTILATION, AIR CONDITIONING AND REFRIGERATION (HVAC/R) SERVICE TECHNICIAN CERTIFICATE OF CAREER PREPARATION

This certificate provides the basic knowledge and skills necessary for job opportunities in heating, ventilation and air conditioning.

Units Required: 17.0

Group I - All of the following must be completed:

CT 116	Construction Safety	2.0
CT 122A	Heating and Air Conditioning	4.0
CT 122B	Commercial Refrigeration	4.0
CT 136	HVAC Circuits and Controls	4.0

Group II - One of the following must be completed:

CT 107	Technical Math	3.0
CT 108	Advanced Technical Math	3.0

Construction and Manufacturing Technology

PLUMBING TECHNICIAN CERTIFICATE OF CAREER PREPARATION		
This certificate provides the necessary knowledge and skill level required for employment in the plumbing industry.		
Units Required: 15.0		
<i>Group I - All of the following must be completed:</i>		
CT 113	Uniform Plumbing Code	3.0
CT 116	Construction Safety	2.0
CT 124	Plumbing	4.0
CTMT 121	Plumbing Repair	3.0
<i>Group II - One of the following must be completed:</i>		
CT 107	Technical Math	3.0
CT 108	Advanced Technical Math	3.0
PUBLIC WORKS CERTIFICATE OF ACHIEVEMENT (07569)		
This certificate provides the necessary skill level for employment on public works projects. Public works includes construction of streets and highways, water distribution systems, and waste water systems.		
Units Required: 18.0 - 19.0		<i>Students must complete their Construction Technology Certificate plus all the following:</i>
<i>Group I - All of the following must be completed:</i>		
CTPW 111	Introduction to Public Works	3.0
CTPW 112	Plan Reading for Public Works	3.0
CTPW 113	Public Works Inspection	3.0
CTPW 114	Public Works Administration	3.0
<i>Group II - Two of the following must be completed:</i>		
CT 123	Surveying	4.0
CTPW 115	Street and Highway Construction	3.0
CTPW 116A	Water Distribution Systems I	3.0
CTPW 117	Portland Cement Concrete	3.0
CTPW 118	Solid Waste Management	3.0
CTPW 119	Wastewater Operations	3.0
BASIC RESIDENTIAL MAINTENANCE TECHNICIAN CERTIFICATE OF CAREER PREPARATION		
This certificate provides the necessary knowledge and skill level required for employment in the residential maintenance and repair industry.		
Units Required: 15.0		
<i>Group I - All of the following must be completed:</i>		
CT 107	Technical Math or	3.0
CT 108	Advanced Technical Math	3.0
CT 116	Construction Safety	2.0
CTMT 120	Residential Maintenance and Repair	4.0
CTMT 121	Plumbing Repair	3.0
CTMT 122	Electrical Repair	3.0

Construction and Manufacturing Technology

BASIC WOODWORKING CERTIFICATE OF CAREER PREPARATION

This certificate demonstrates a basic understanding of wood, joinery and woodworking skills and the ability to safely and appropriately use common hand tools, power tools and equipment to perform common woodworking tasks. This certificate can lead to employment in a wide variety of woodworking trades.

Units Required: 17.0

Group I - All of the following must be completed:

CTMF 120A	Woodworking Tools and Equipment	2.0
CTMF 121A	Woodworking	3.0
CTMF 121B	Intermediate Woodworking	3.0
CTMF 122	Advanced Wood Topics	3.0
CTMF 129A	Woodturning	3.0
CTMF 129B	Advanced Woodturning	3.0

RENEWABLE ENERGY CERTIFICATE OF CAREER PREPARATION

This certificate demonstrates an understanding of renewable generation and the effects of fossil fuel use on our environment, economy and society. This certificate can lead to employment in the renewable energy field.

Units Required: 14.0 - 17.0

Group I - All of the following must be completed:

CT 105	Technical Sketching	3.0
CT 142	Renewable Energy	3.0
CTMT 122	Electrical Repair	3.0

Group II - One of the following must be completed:

CT 107	Technical Math	3.0
CT 108	Advanced Technical Math	3.0

Group III - One of the following must be completed:

CT 143A	Renewable Energy Lab A Photovoltaic	2.0-5.0
CT 143B	Renewable Energy Lab B Solar Thermal	2.0-5.0
CT 143C	Renewable Energy Lab C Wind	2.0-5.0
CT 143D	Renewable Energy Lab D Alternative Fuels	2.0-5.0

BASIC MACHINING CERTIFICATE OF CAREER PREPARATION

This certificate provides the knowledge and basic skills for job opportunities in manufacturing, as well as pre-requisite knowledge and skills for Fabrication and Advanced Manufacturing programs.

Units Required: 16.0

Group I - All of the following must be completed:

CIDG 95	Introduction to SolidWorks	3.0
CT 107	Technical Mathematics	3.0
CT 116	Construction Safety	2.0
WELD 58A	Gas Metal Arc Welding Basic	2.0
WELD 58G	Gas Metal Arc Welding Advanced	2.0
WELD 59	Welding Symbols and Blueprint Reading	1.0

Construction and Manufacturing Technology Courses

CT 60A/B/C/D CONSTRUCTION LABORATORY

Units: 1-4.0 | 48-54 hours laboratory per unit

(No prerequisites)

A variable unit laboratory class to provide intermediate skill development in the following areas: electrical wiring, finish carpentry, heating and air conditioning, framing, plumbing and concrete and masonry construction. Students will complete contract projects.

CT 90 INTRODUCTION TO CONSTRUCTION

Units: 3.0 | [CSU](#) | 48-54 hours lecture

(No prerequisites)

A foundational Construction course that prepares students for further Construction education and training. Topics include: tool safety and use, construction drawings, math, safety, and basic employability skills. Students who complete both CT 90 and CT 91 can test to be certified in the Core Curriculum of the National Center for Construction Education and Research, a national construction certification.

CT 91 INTRODUCTION TO CONSTRUCTION

Units: 2.0 | [CSU](#) | 98-108 hours laboratory

(Corequisites: CT 90)

Lab and skill performance companion to CT 90, prepares students for further Construction education and training. Topics include: tool safety and use, construction drawings, math, safety, and basic employability skills. Students who complete both CT 90 and CT 91 can test to be certified in the Core Curriculum of the National Center for Construction Education and Research, a national construction certification.

CT 101 CAREERS IN CONSTRUCTION AND MANUFACTURING

Units: 1.5 | [CSU](#) | 24-27 hours lecture

(No prerequisites)

This course is designed to provide the construction, manufacturing and drafting technology student with information and skills necessary to understand current job market needs and prepare a successful educational plan to obtain their desired goals. Students will develop an awareness of occupations and develop skills for seeking employment and completing job applications, resumes and interviews.

CT 103 CONSTRUCTION MANAGEMENT

Units: 3.0 | [CSU](#) | 48-54 hours lecture

(No prerequisites)

Principles of management as they specifically relate to the construction industry. This course explores the relationship and importance of proper planning, estimating, contracting, financing and building. Also covered are leadership and supervisory skills, employer/employee relationships and safety.

CT 104 CONSTRUCTION LAW

Units: 3.0 | [CSU](#) | 48-54 hours lecture

(No prerequisites)

Principles of contracting, real estate and construction law. Course includes legal aspects of building codes, contractors' licenses, worker's compensation, social security, state safety regulations and lien laws as they apply to the construction trade.

CT 105 TECHNICAL SKETCHING

Units: 3.0 | [CSU](#) | 32-36 hours lecture and 48-54 hours laboratory

(No prerequisites)

A course designed to develop sketching skills and introduce sketching techniques currently used in the industrial and architectural fields. Course will include principles of oblique, isometric and perspective sketching, including shading and shadows.

Construction and Manufacturing Technology Courses

CT 106 MATERIALS OF CONSTRUCTION

Units: 3.0 **CSU** | 48-54 hours lecture

(No prerequisites)

A study of common materials used in residential and commercial construction. Course includes use and limitations of soil, paving materials, concrete, lumber, wall materials, roofing, insulation, siding, sheet material, electrical and plumbing materials and fixtures. This course will also explore the use of steel, aluminum and plastics in modern construction.

CT 107 TECHNICAL MATHEMATICS

Units: 3.0 **CSU** | 48-54 hours lecture

(No prerequisites)

A review of basic arithmetic, fractions, decimals and percentages. Introduction to basic algebra and trigonometry as they apply to the manufacturing and construction trades.

CT 108 ADVANCED TECHNICAL MATH

Units: 3.0 **CSU** | 48-54 hours lecture

(No prerequisites)

This course will include the practical applications of algebra, geometry and trigonometry. Class emphasis will be on the solution of technical problems commonly found in the fields of engineering, drafting, manufacturing and construction.

CT 109 CONSTRUCTION FINANCING

Units: 3.0 **CSU** | 48-54 hours lecture

(No prerequisites)

This course introduces the basic issues and concepts of construction finance. Course examines the procedures for evaluation of all types of real estate credit and is designed to enable borrowers to utilize their resources to obtain financing.

CT 110 BUILDING CODES AND ZONING

Units: 3.0 **CSU** | 48-54 hours lecture

(No prerequisites)

Use of the International Building Code and the various related state and local ordinances for plan checking and building compliance. Course includes a basic understanding of building codes and zoning as they apply to the construction and inspection of residential and light commercial buildings.

CT 111A INTERNATIONAL BUILDING CODE I

Units: 3.0 **CSU** | 48-54 hours lecture

(No prerequisites)

The first of a two part, in-depth study of the contents and applications of the International Building Code and California amendments with emphasis on residential construction. This course includes building classifications by occupancy and type, engineering regulations and design requirements applicable to plan checking and structural building inspection.

CT 111B INTERNATIONAL BUILDING CODE II

Units: 3.0 **CSU** | 48-54 hours lecture

(No prerequisite. Grade Option.)

A continuing in-depth study of the International Building Code and California amendments with emphasis on commercial applications. Course includes energy conservation standards, specialized commercial structures, public safety and standards for handicapped accessibility.

CT 112 UNIFORM MECHANICAL CODE

Units: 3.0 **CSU** | 48-54 hours lecture

(No prerequisite)

This class is an in-depth study of the contents and applications of the Uniform Mechanical Code. Course covers the use of this code for plan checks and inspection of residential and commercial structures.

Construction and Manufacturing Technology Courses

CT 113 UNIFORM PLUMBING CODE

Units: 3.0 **CSU** | 48-54 hours lecture

(No prerequisite)

This class is an in-depth study of the contents and applications of the Uniform Plumbing Code. Course includes underground and above ground water, gas and air pipe installations for residential and commercial structures.

CT 114 NATIONAL ELECTRICAL CODE

Units: 3.0 **CSU** | 48-54 hours lecture

(No prerequisite)

This class is an in-depth study of the contents and applications of the National Electrical Code. Course covers the use of the code for plan checks and inspection of residential and commercial structures. Plan reading, electrical theory, wiring methods and installation of electrical components and fixtures are also included.

CT 115 TECHNICAL OFFICE PROCEDURES AND FIELD INSPECTION

Units: 3.0 **CSU** | 48-54 hours lecture

(No prerequisite)

Office organization, procedures and necessary paper-work pertinent to building and safety office management and inspection. Field inspection for completed building, zoning, health and safety ordinance applications. Course includes several field trips.

CT 116 CONSTRUCTION SAFETY

Units: 2.0 **CSU** | 32-36 hours lecture

(No prerequisite)

Covers OSHA policies, procedures, and standards, as well as safety for general industry and health principles. Topics include scope and application of the OSHA general industry standards. Special emphasis is placed on those areas that are the most hazardous, using OSHA standards as a guide. Upon successful course completion, the student will receive either an OSHA 10 or 30 hour general industry or construction industry training completion card. 36 hours lecture.

CT 119 LOAD CALCULATIONS AND CIRCUIT DESIGN

Units: 3.0 **CSU** | 32-36 hours lecture and 48-54 hours laboratory

(No prerequisite)

This course is designed to develop the skills necessary to visualize and correctly interpret drawings, diagrams, blueprints, and schematics common to the electrical industry. Course includes branch and feeder circuit design and load calculations as they apply to residential, multi-family, commercial and industrial applications.

CT 120A ELECTRICAL WIRING

Units: 4.0 **CSU** | 32-36 hours lecture and 96-108 hours laboratory

(No prerequisite)

Theory, procedure and techniques for electrical wiring of residential and light commercial construction. Topic areas include blueprint reading, power panels, wire sizing, conduit bending and installation, pulling and installation of wires, lighting and plug circuitry, designated circuits, underground and swimming pool wiring.

CT 120B COMMERCIAL WIRING

Units: 4.0 **CSU** | 32-36 hours lecture and 96-108 hours laboratory

(Prerequisite: CT 120A)

Learn the techniques necessary for commercial wiring. Size conductors for motor, intermittent and continuous loads. Wire for single and three phase services. Course includes wiring techniques common to commercial applications, running circuits with flex, electrical metallic tubing, rigid and liquid tight conduits and use of common conductors, cables, boxes and raceways. Also included are transformers and motor load calculations, starters and over current protection devices.

Construction and Manufacturing Technology Courses

CT 121 FINISH CARPENTRY

Units: 4.0 **CSU** | 32-36 hours lecture and 96-108 hours laboratory

(No prerequisite)

Course covers use of hand and machine woodworking tools and techniques common to finish carpentry and cabinet making. Students will develop skill in safe and efficient operation of common tools, layout, cutting, assembly and finish of woodworking projects.

CT 122A HEATING AND AIR CONDITIONING

Units: 4.0 **CSU** | 32-36 hours lecture and 96-108 hours laboratory

(No prerequisite)

This course provides instruction for layout, installation and repair of common residential and light commercial heating and air conditioning systems. Heating and air conditioning theory and energy calculations will be treated in depth. Course also includes use of solar energy for heating and cooling.

CT 122B COMMERCIAL REFRIGERATION

Units: 4.0 **CSU** | 32-36 hours lecture and 96-108 hours laboratory

(Prerequisite: CT 122A)

Explore the more complex commercial and industrial uses of refrigeration, heating and air conditioning. Course covers installation and repair of the most common commercial refrigeration systems found in the food industry and industrial and manufacturing environments. Also included are computer controlled and central plant environmental systems, high and low pressure chillers, cooling towers and air handlers.

CT 122C HEAT PUMP FUNDAMENTALS AND CONTROLS

Units: 4.0 **CSU** | 48-54 hours lecture and 48-54 hours laboratory

(No prerequisite)

This course explores electrical and mechanical circuitry fundamentals, along with theory, operation and application of heat pump systems used in residential and light commercial heating installations including the heat pump refrigeration cycle, reversing valves, defrost methods of supplemental heat, balance point, air flow, and heat pump thermostats.

CT 123 SURVEYING

Units: 4.0 **CSU** | 32-36 hours lecture and 96-108 hours laboratory

(No prerequisite)

A course designed to explore the principles and applications of surveying. Students will develop skill in the operation of surveying equipment used for measuring, leveling and locating of points. Course includes surveying techniques common to building and highway construction, general land surveying, hydrographic surveys and photogrammetric mapping.

CT 124 PLUMBING

Units: 4.0 **CSU** | 32-36 hours lecture and 96-108 hours laboratory

(No prerequisite)

This course provides instruction for layout and installation of residential and light commercial plumbing systems and fixtures. Rough and finish stages of plumbing will be introduced and students will become familiar with reading plans and calculating and constructing the plumbing system.

CT 125 CONCRETE AND MASONRY CONSTRUCTION

Units: 4.0 **CSU** | 32-36 hours lecture and 96-108 hours laboratory

(No prerequisite)

Course covers use of hand and machine tools and techniques common to residential and light commercial concrete and masonry construction. Plan reading, layout, forming, pouring of concrete, tilt-up and various finishing techniques will be introduced. Course also includes construction with brick, stone, concrete block, and other masonry shapes.

Construction and Manufacturing Technology Courses

CT 126 EXPLORING BRICK AND BLOCK

Units: 1.5 **CSU** | 16-18 hours lecture and 24-27 hours laboratory

(No prerequisite. Grade Option)

This course includes techniques used for construction of brick and block walls, decorative brick patios, planter edging and concrete slabs, curbs and walks. Class covers information on concrete and mortar mixes and proper forming, pouring and finishing of concrete slab and wall footings.

CT 127 FRAMING

Units: 4.0 **CSU** | 32-36 hours lecture and 96-108 hours laboratory

(No prerequisite)

Course covers use of hand and machine tools and techniques common to rough carpentry and residential and light commercial framing. Students will develop skill in safe and efficient operation of common tools, layout techniques, cutting and assembly of wall, ceiling and roof framing, and installing sheathing and insulation.

CT 129 INDEPENDENT STUDY

See Independent Study listing (1-4 units). **CSU**

CT 130 RESIDENTIAL REMODELING

Units: 3.0 **CSU** | 32-36 hours lecture and 48-54 hours laboratory

(No prerequisite. Grade Option)

Learn the skills and techniques necessary for remodeling of residential structures. Course includes project planning, estimation and layout. Gain experience in framing, plumbing, electrical drywall, floor and wall finishing and concrete with projects that include patio and deck construction, room additions and kitchen and bathroom remodeling.

CT 131 MICROCOMPUTERS IN CONSTRUCTION

Units: 4.0 **CSU** | 48-54 hours lecture and 48-54 hours laboratory

(No prerequisite)

This course is designed to introduce the student to the potentials of the computer as it directly applies to the construction industry. Course includes instruction and practice in the following common program types: operating system, word processing, presentation, spreadsheet, email, web-page design, publishing estimation, and introductory computer-aided drafting.

CT 132 CONSTRUCTION ESTIMATION

Units: 3.0 **CSU** | 48-54 hours lecture

(No prerequisite)

Learn how to bid accurately and profitably. Course will teach you how to account for materials, labor, taxes, insurance, overhead, and profits across various trades in preparing winning estimates. Speed up your estimating process and increase your accuracy using today's leading construction estimation software. Estimating software allows take-offs using quick, single and assembly methods to meet your particular estimating needs.

CT 133 PRECISION ESTIMATION

Units: 3.0 **CSU** | 32-36 hours lecture and 32-36 hours by arrangement

(No prerequisite)

Learn how to speed up your estimating process and increase your accuracy using today's leading construction estimating software. Estimating software allows take-off using quick, single and assembly methods. Course includes development and maintenance of your database. Create your own crews, add-ons, formulas and assemblies to meet your particular estimating needs.

Construction and Manufacturing Technology Courses

CT 136 HVAC CIRCUITS AND CONTROLS

Units: 4.0 **CSU** | 48-54 hours lecture and 48-54 hours laboratory

(No prerequisite)

This course explores electrical fundamentals common to the heating, ventilation, air conditioning and refrigeration fields. Course includes electrical theory, control circuitry and electronics, system supply circuitry and alternating and direct current troubleshooting.

CT 137 SHEET METAL FABRICATION

Units: 3.0 **CSU** | 32-36 hours lecture and 48-54 hours laboratory

(No prerequisite)

This course will introduce the student to the fundamental elements, methods and principals of sheet metal design, fabrication and installation. Course includes air handling systems, gutters, flashings, coping, tanks and exhaust systems. Students will gain valuable hands-on skills in the proper use of metal working hand and machine tools through the completion of multiple projects.

CT 138 COOPERATIVE EDUCATION

See Cooperative Education listing (1-8 units) **CSU**

CT 140 CONSTRUCTION INTERNSHIP

Units: 4.0 **CSU** | 64-72 hours lecture

(No prerequisite. Grade Option)

Gain valuable hands-on construction skills by participating in the creation and operation of a small construction business. Students will research the market, design the project, estimate the costs, develop a business plan, secure a construction loan, prepare a schedule and analyze the projects progress and perform customer service and sales.

CT 141 CONSTRUCTION INTERNSHIP LABORATORY

Units: 2-12.0 **CSU** | 6 hours weekly by arrangement per unit

(No prerequisite. Co-requisite: CT 140. Grade Option)

This course is the laboratory component for CT 140 Construction Internship. Students will research, develop, construct and market a construction project using computers and common construction tools and equipment.

CT 142 RENEWABLE ENERGY FUNDAMENTALS

Units: 3.0 **CSU** | 48-54 hours lecture

(No prerequisite.)

This course explores methods of generation and use of renewable energy. Topics include renewable fuel based generators, fuel cells, wave and tidal generation, geothermal, wind turbines, photovoltaic, barometric pressure, and hydroelectric generation. Course also covers active and passive solar heating and cooling, alternate fuel vehicles and electric transportation.

CT 143A RENEWABLE ENERGY LAB A: PHOTOVOLTAIC

Units: 2-5.0 **CSU** | 16-18 hours lecture and 48-54 hours per unit of laboratory per term

(Prerequisite/Co-requisite: CT 142)

This course explores using photovoltaic technology to generate electricity for various applications: residential, remote, portable, auxiliary, or mobile.

CT 143B RENEWABLE ENERGY LAB B: SOLAR THERMAL

Units: 2-5.0 **CSU** | 16-18 hours lecture and 48-54 hours per unit of laboratory per term

(Prerequisite/Co-requisite: CT 142)

This course explores using solar thermal technology for various applications including passive/active heating/cooling and generating electricity.

Construction and Manufacturing Technology Courses

CT 143C RENEWABLE ENERGY LAB C: WIND

Units: 2-5.0 **CSU** | 16-18 hours lecture and 48-54 hours per unit of laboratory per term

(Prerequisite/Co-requisite: CT 142)

This course explores renewable energy with a focus on wind electrical generation through the completion of actual projects.

CT 143D RENEWABLE ENERGY LAB D: ALTERNATIVE FUELS

Units: 2-5.0 **CSU** | 16-18 hours lecture and 48-54 hours per unit of laboratory per term

(Prerequisite/Co-requisite: CT 142)

This course explores using alternative fuels for transportation, heating systems, and generating electricity through the construction of an actual project.

CT 144 PHOTOVOLTAIC SYSTEMS AND INSTALLATION

Units: 6.0 **CSU** | 64-72 hours lecture and 96-108 hours laboratory

(No prerequisite)

This course will prepare students for a career in the Residential Solar Industry. At the conclusion of the course, students may take the national entry-level NABCEP Certification Exam. Students will explore photovoltaic energy and systems, and the methods used to install residential systems. System components, building code requirements, system sizing and design, and solar energy principles will be examined extensively. During lab hours, students will conduct experiments that demonstrate the principles of photovoltaic and electrical systems. Students will design, safely install, and trouble-shoot systems on actual buildings and ground mounts.

CT 148 SPECIAL TOPICS

See Special Topics listing (Variable units) **CSU**

Construction Technology Manufacturing Courses

CTMF 50 GENERAL MACHINE SHOP

Units: 3.0 **CSU** | 16-18 hours lecture and 96-108 hours laboratory

(No prerequisite)

This introductory course instructs students in the basic set up and operation of the lathe, mill, saw, drill press, and grinder. Safety, blueprint reading, measurement, shop math, tool grinding, and speed & feed calculations also included.

CTMF 120A WOODWORKING TOOLS AND EQUIPMENT

Units: 2.0 **CSU** | 32-36 hours lecture

(No prerequisite)

This course is designed to give the woodworking student an in-depth knowledge of common woodworking tools and equipment. Students will explore the safety, use and maintenance of saws, lathes, routers, planers, jointers, sanders and common power and hand tools used for basic woodworking projects.

CTMF 120B ADVANCED WOODWORKING TOOLS AND EQUIPMENT

Units: 2.0 **CSU** | 32-36 hours lecture

(Prerequisite: CTMF 120A.)

This course is designed to give the woodworking student an in-depth knowledge of the more advanced woodworking tools, equipment and operations. Students will explore the safety, setup, use and maintenance of saws, lathes, routers, planers, jointers, sanders and common power and hand tools as used in advanced woodworking projects. Course also includes extensive coverage of tool sharpening.

Construction Technology Manufacturing Courses

CTMF 121A WOODWORKING

Units: 3.0 **CSU** | 32-36 hours lecture and 48-54 hours laboratory

(No prerequisite)

This is a beginning woodworking class. Topics covered include safety, tools, the composition of wood and its characteristics, beginning design and sketching, project planning, measuring and cutting, use of large and small power tools, and general woodworking techniques. Students will be expected to complete multiple projects as part of their grade.

CTMF 121B INTERMEDIATE WOODWORKING

Units: 3.0 **CSU** | 32-36 hours lecture and 48-54 hours laboratory

(Prerequisite: CTMF 121A)

This is an intermediate woodworking class. Topics include safety, tools, the composition of wood and its characteristics, finishing, intermediate design and sketching, and project planning. Students will generate shop drawings adequate to build the project. Students will measure, cut, and use power tools and general woodworking techniques.

CTMF 121C ADVANCE WOODWORKING

Units: 3.0 **CSU** | 32-36 hours lecture and 48-54 hours laboratory

(Prerequisite: CTMF 121B with a grade of "C" or better)

This is an advanced course in fine woodworking using techniques common to custom wood products, furniture making and wood art. Learn the artisan's techniques for wood joining, carving, turning and finishing by completing various wood projects. Course includes a study of common woods, tools and methods for shaping and finishing.

CTMF 122 ADVANCED WOOD TOPICS

Units: 3.0 **CSU** | 32-36 hours lecture and 48-54 hours laboratory

(Prerequisite: CTMF 121A Basic Woodworking. Grade Option)

Come develop your skills and learn the methods and procedures necessary for completing an advanced woodworking project. One specific advanced woodworking project is selected as the focus for each semester. Check with the Construction Technology Department for the current project. Course may also include specialized techniques of turning, marquetry, parquetry, carving and intarsia.

CTMF 127 PRODUCTION WOODWORKING

Units: 3.0 **CSU** | 32-36 hours lecture and 48-54 hours laboratory

Prerequisite: CTMF 121A)

This course covers techniques common to production woodworking and includes design and construction of custom jigs, fixtures and templates for drill presses, routers, saws and lathes. Students will gain experience with computer numerical controlled routers, surfacing sanders, airbag sanders and production fastening techniques and wood finishes while creating several commercial woodworking projects.

CTMF 129A WOODTURNING

Units: 3.0 **CSU** | 32-36 hours lecture and 48-54 hours laboratory

CSU (Prerequisite: CTMF 120A)

This introductory course will provide the woodworking student with information and skills necessary to successfully design, turn and finish typical woodturning projects. Course includes lathe, spindle, faceplate and drive chuck turning. Students will complete a variety of projects that can include pens and pencils, games and toy pieces, decorations, lamps, spindles, bowls and boxes.

CTMF 129B ADVANCED WOODTURNING

Units: 3.0 **CSU** | 32-36 hours lecture and 48-54 hours laboratory

(Prerequisite: CTMF 129A. Grade Option)

This advanced woodturning course includes green, seasoned and laminated wood and acrylic projects. Students will explore turning of large bowls and platters, maintaining natural edges, turning burls, proper box and lid construction, off center turning, chatter finishes and construction of turning fixtures, centers and drives.

Construction Technology Manufacturing Courses

CTMF 130A MECHANICAL DESKTOP

Units: 3.0 **CSU** | 32-36 hours lecture and 32-36 hours by arrangement

(No prerequisite. Grade Option.)

Develop your skill in creating accurate three-dimensional parametric models using Mechanical Desktop. Explore the exciting features of this program which includes parametric modeling, surfacing, model analysis, interference checking and assemblies. Learn how to export surface and design information to computer controlled mills and routers. This is an introductory class in Mechanical Desktop.

CTMF 130B MECHANICAL DESKTOP ADVANCED

Units: 3.0 **CSU** | 32-36 hours lecture and 32-36 hours by arrangement

(Prerequisite: CTMF 130A)

This advanced course in Mechanical Desktop includes a focused exploration of detailed models and complex assembly models. Students will explore the full features of the Mechanical Desktop package including fasteners, shaft and gear generation and creation of motion based, skin and derived surfaces. Both localized and externalized assemblies will be created and analyzed for interference and engineering characteristics.

CTMF 131A COMPUTER AIDED MANUFACTURING (CAM) SOFTWARE

Units: 3.0 **CSU** | 16-18 hours lecture and 96-108 hours laboratory

(No prerequisite)

Learn the techniques of numerical controlled programming using Computer-Aided Manufacturing (CAM) software. Generate three-dimensional models and learn how to create parts, molds, and fixtures using integrated solids, surfaces and wireframes. Unite the software with the machine and create milled or routed three-dimensional parts.

CTMF 131B COMPUTER AIDED MANUFACTURING (CAM) SOFTWARE ADVANCED

Units: 3.0 **CSU** | 16-18 hours lecture and 96-108 hours laboratory

(Prerequisite: CTMF 131A.)

This advanced course includes an in-depth study of the more complex features of Computer-Aided Manufacturing (CAM) software. Students will create geometry and toolpaths for complex three-dimensional and surface models for mills, routers, lathes and engraving machines. Programming of multi-axis and mill-turn machines will be explored.

CTMF 140 MANUFACTURING INTERNSHIP

Units: 1.0 **CSU** | 48-54 hours laboratory

(No prerequisite. Grade Option)

This course will provide the construction, drafting and manufacturing technology student with hands-on job skills and experience common to the manufacturing industry.

CTMF 141 MANUFACTURING INTERNSHIP LABORATORY

Units: 2.0 **CSU** | 96-108 hours laboratory

(Corequisite: CTMF 140. Grade Option- Student makes choice of letter grade or Pass/No Pass)

This course is the laboratory component for CTMF 140 Manufacturing Internship. Students will research, design, manufacture and market a project using computers and common manufacturing equipment. CTMF 140 must be taken concurrently.

Construction Technology Maintenance Courses

CTMT 120 RESIDENTIAL MAINTENANCE AND REPAIR

Units: 4.0 **CSU** | 48-54 hours lecture and 48-54 hours laboratory

(No prerequisite. Grade Option)

This class covers all major aspects of preventative maintenance and repair for residential and light commercial buildings. Topics covered include but are not limited to repairing roofing, plumbing, electrical framing, insulation, drywall, painting, concrete, flooring, safety, tools, heating and cooling, etc. as they apply to the maintenance and repair industry.

Construction Technology Maintenance Courses

CTMT 121 PLUMBING REPAIR

Units: 3.0 **CSU** | 32-36 hours lecture and 48-54 hours laboratory

(No prerequisite. Grade Option)

This class covers most aspects of residential and light commercial plumbing repair. Topics covered include but are not limited to plumbing tools, water supply systems, drainage systems, drainage problems, faucets and valves, piping, soldering and threading, water heating systems, plumbing fixtures, pricing, billing, and inventory management, as they apply to the plumbing repair business.

CTMT 122 ELECTRICAL REPAIR

Units: 3.0 **CSU** | 32-36 hours lecture and 48-54 hours laboratory

(No prerequisite. Grade Option)

This class covers most aspects of residential and light commercial electrical repair. Topics covered included but are not limited to electrical tools, electrical theory, wiring systems electrical materials, electrical services, troubleshooting electric circuits, low voltage circuits, appliances and motors, and mathematics for electricians.

CTMT 123 CUSTODIAL MAINTENANCE

Units: 4.0 **CSU** | 48-54 hours lecture and 48-54 hours laboratory

(No prerequisite. Grade Option)

This course covers the major aspects of custodial and janitorial work. Course includes general cleaning techniques, cleaning equipment use and maintenance, cleaning chemicals, window care, maintaining hard floors, carpet and upholstery care, chemical hazards, Cal OSHA regulations, and handling of infectious waste as they apply to the janitorial industry.

Construction Technology Public Works Courses

CTPW 111 INTRODUCTION TO PUBLIC WORKS

Units: 3.0 **CSU** | 48-54 hours lecture

(No prerequisite)

Introduction to techniques, materials and equipment used in Public Works maintenance and construction. Meets the standards of the American Public Works Association, Street Superintendents' Association and Inspectors' Association.

CTPW 112 PLAN READING FOR PUBLIC WORKS

Units: 3.0 **CSU** | 48-54 hours lecture

(No prerequisite)

Reading and interpreting plans related to public works, water, storm drain, and sewage facility projects. Basic survey methods, symbols, mathematical conversions, and determination of slope and grade.

CTPW 113 PUBLIC WORKS INSPECTION

Units: 3.0 **CSU** | 48-54 hours lecture

(No prerequisite)

General public works inspection techniques. Includes Portland Cement and asphalt concretes, soils, base and subgrade, safety, contracts, and specifications. Responsibilities of the contractor, engineer, agency, and inspector.

Construction Technology Public Works Courses

CTPW 114 PUBLIC WORKS ADMINISTRATION

Units: 3.0 **CSU** | 48-54 hours lecture

(No prerequisite)

An introduction to the organizational concepts used by the Public Works department. Includes typical organization, management concepts, political considerations, planning, budget management and public relations.

CTPW 115 STREET AND HIGHWAY CONSTRUCTION

Units: 3.0 **CSU** | 48-54 hours lecture

(No prerequisite)

Equipment, materials, and methods employed in the construction, inspection, and maintenance of streets and highways. Includes Portland Cement concrete; surface drainage; traffic signs; safety and safe practices, highway design; laws, codes and ordinances; management principles; budget preparations; equipment maintenance records; underground utilities; surveying and staking.

CTPW 116A WATER DISTRIBUTION SYSTEMS I

Units: 3.0 **CSU** | 48-54 hours lecture

(No prerequisite)

Water distribution systems operation. Fundamentals of water production, quality, and system operation. Includes piping, services, pumps, reservoirs, mathematics, and basic hydraulics. Preparation for Grades I and II Water Distribution Operator Certification.

CTPW 117 PORTLAND CEMENT CONCRETE

Units: 3.0 **CSU** | 48-54 hours lecture

(No prerequisite)

Portland Cement concrete design and uses. Covers transporting, placing, curing, and testing Portland Cement concrete. Applications and construction methods employed.

CTPW 118 SOLID WASTE MANAGEMENT

Units: 3.0 **CSU** | 48-54 hours lecture

(No prerequisite)

Methods used in collection of solid waste materials. Includes equipment, scheduling, and customer relations. Ultimate disposal of solid waste matter as well as projections concerning future collection and disposal operations. Special emphasis on municipal resource recovery, salvaging, and recycling.

CTPW 119 WASTEWATER OPERATIONS

Units: 3.0 **CSU** | 48-54 hours lecture

(No prerequisite)

Comprehensive examination of wastewater operations, impact of waste contributions from home and industry, effects of wastewater treatment, water reclamation and by-product disposal.

Cooperative Work Experience Education

Cooperative Education is a key element of Victor Valley College's comprehensive approach to career development. Cooperative Education is a 16-, 12-, or 8-week course that enables the student to receive college credit for on-the-job training that will make him/her a more efficient and valuable employee while providing a practical education that supplements and enhances classroom theory. It relates education to real work environments through learning while earning. It also provides the opportunity for work improvement by improving skills. Victor Valley College recognizes job experience as a valuable learning resource. It has the uniqueness of turning community business, industry, and public agencies into an expanded educational training laboratory. Cooperative Education also allows credit for volunteer or unpaid training. Credit is awarded on the basis of learning objectives completed and the number of hours the student trains. Students must create/complete new learning objectives each semester they enroll. Students may utilize their present worksites. More details are available in the Cooperative Education Office, (760) 245-4271, ext. 2281. The office, located in the Academic Commons, is open Monday-Friday, 8:30 a.m.-1:00 p.m., 2:00-5:00 p.m., and by appointment.

Cooperative Education is a course designed for students who are cross-training at their current worksite for upward mobility or possible career changes as well as those looking for entry-level occupational training through work-based learning experiences such as through an internship.

Are you looking for occupational skills training for employment? We can offer you:

- Practical experience
- An opportunity to apply classroom learning on the job
- College credit
- Career guidance in a realistic setting
- A chance to learn what you do well and what you enjoy doing
- A reason for staying in college
- Up-to-date laboratory experience
- Orientation to changing job conditions
- New ways of getting ahead
- Opportunity to experience socialization in the work place
- Transferable college elective units

Credit is awarded on the basis of objectives completed and the number of hours worked. You will need a minimum of 75 hours of paid work for each unit of credit or 60 hours of unpaid work for each unit of credit.

PAID

<i>75 hrs per unit/per semester</i>		Total semester hours
05 hrs/wk	1.0 unit	75
10 hrs/wk	2.0 units	150
15 hrs/wk	3.0 units	225
20 hrs/wk	4.0 units	300
25 hrs/wk	5.0 units	375
30 hrs/wk	6.0 units	450
35 hrs/wk	7.0 units	525
40 hrs/wk	8.0 units	600

UNPAID

<i>60 hrs per unit/per semester</i>		Total semester hours
04 hrs/wk	1.0 unit	60
08 hrs/wk	2.0 units	120
12 hrs/wk	3.0 units	180
16 hrs/wk	4.0 units	240
20 hrs/wk	5.0 units	300
24 hrs/wk	6.0 units	360
27 hrs/wk	7.0 units	420
32 hrs/wk	8.0 units	480

Eligibility

Students must utilize their present work site, as we do not place students at work sites. Students do not need a declared major and do not need to be working in a major to enroll in Cooperative Work Experience Education.

To be eligible for Cooperative Education, students must:

- Be enrolled as a Victor Valley Community College student.
- Spend at least five (5) hours a week at a work site.
- Pursue a planned program of Cooperative Education that includes new or expanded responsibilities or learning opportunities beyond those of previous employment and training.

Cooperative Work Experience Education

Credit

Students may earn between 1 and 8 units of Cooperative Education credit per semester, depending on the number of hours completed. Students may enroll again in Occupational Work Experience classes but may not exceed 16 units total. A maximum of 16 units of Cooperative Education credit may be used towards the AA/AS degree as elective credits only. Units cannot be applied towards major or general education degree requirements. These units also transfer to the CSU system as elective credits only.. General Work Experience does not transfer. Students may repeat a failed Cooperative Education class and both grades will be listed on the student's transcript.

Cooperative Education Work Experience is offered in the following areas:

Administration of Justice, Agriculture and Natural Resources, Allied Health, Art, Automotive, Biology, Business Administration, Business Education Technologies, Business Escrow, Business Real Estate, Chemistry, Child Development, Computer Information Science, Computer Integrated Design & Graphics (Drafting), Construction & Manufacturing Technology, Education, Electronics and Computer Technology, English, Fire Technology, General Work Experience , Journalism, Mathematics, Music, Nursing, Photography, Physical Science, Physics, Political Science, Psychology, Respiratory Therapy, Restaurant Management, Sociology, Theater Arts, Welding,

For further information and individual guidance, contact the Cooperative Education Office at 245-4271, ext. 2281, or visit www.vvc.edu/offices/coopedu

Developmental Studies

Developmental Studies courses offer language analysis curriculum specifically designed for students with language based disabilities. The curriculum is a multisensory, sequential, and cognitive approach which includes both perceptual and neurological deficit therapy.

Developmental Studies Courses

DVST 1 LANGUAGE ANALYSIS DEVELOPMENT 1

Units: 3.0

48-54 hours lecture

(No prerequisites) This course does not apply to the Associate Degree.

This course is designed for students who would like to learn how to read and spell phonetically. The sounds and rules governing the sounds are introduced to the students. The students are then given opportunity to encode and decode words using this phonetic instruction.

DVST 2 LANGUAGE ANALYSIS DEVELOPMENT 2

Units: 3.0

48-54 hours lecture

(No prerequisite. Pass/No Pass) This course does not apply to the Associate Degree.

Language Analysis 2 uses a multisensory sequential approach to teaching the encoding and decoding of multisyllabic words according to the phonetic structure of the words. Students will also learn how to apply the rules governing the phonetic structure in order to enhance both reading and spelling.

DVST 3 LANGUAGE ANALYSIS DEVELOPMENT 3

Units: 3.0

48-54 hours lecture

(No prerequisite. Pass/No Pass) This course does not apply to the Associate Degree.

Language Analysis 3 is a multisensory and structured approach to understanding the skills and techniques that can enhance comprehension of college level text book reading assignments. Specifically, the key words and organizational patterns of the text will be identified and methods for grasping the main idea of the text will be presented.

DVST 4A BASIC MATH REASONING

Units: 3.0

48-54 hours lecture

(No prerequisite. Pass/No Pass) This course does not apply to the Associate Degree.

Basic Mathematics Reasoning addresses the perceptual and language deficits that can interfere with the understanding of mathematical concepts and operations. Instruction is based on assessment of students' needs and includes performing in the four arithmetic operations, with whole numbers, fractions, decimals, and percent. Students will be given hands-on experience to increase their visual perception and to comprehend the language used in mathematics.

DVST 4B DEVELOPMENTAL ALGEBRA

Units: 3.0

48-54 hours lecture

(Prerequisite. DVST 4A. Pass/No Pass) This course does not apply to the Associate Degree.

This course is a continuation of DVST-4A. The course includes the following topics in algebraic context: mathematical methods, techniques, ways of thinking, and problem-solving. Students will be given hands-on experience to increase their visual perception. Graphing is introduced, and geometric applications are stressed. The course develops skills in operations with algebraic expressions, polynomials, algebraic fractions, and solving linear equations.

DVST 10 LEARNING DISABILITY ASSESSMENT

Units: 1.0

16-18 hours lecture

(No prerequisite) This course does not apply to the Associate Degree.

Assessment for learning disability services eligibility. Group and individual testing; basic instruction in study skills, academic accommodations and learning styles. Through both assessment and class exercises, an individual learning profile including strengths and weaknesses and recommended compensating strategies will be developed.

DVST 52 ORIENTATION TO COLLEGE FOR STUDENTS WITH DISABILITIES

Units: 1.0

16-18 hours lecture

(No prerequisite) This course does not apply to the Associate Degree.

Information and assistance for students with disabilities transitioning to college: Application completion, financial aid resources and application process, and Student Educational Plan (SEP) development; successful navigation through the Community College System and Disability Services.

Economists study how society can best use resources such as land, raw materials, capital, and labor. They analyze the relationship between the supply of goods and services and the demand as well as how these goods and services are produced, distributed, and consumed. Some economists work on public issues such as the control of inflation, business cycles, unemployment, wage, tax, and tariff policies. Others collect, analyze, and interpret data on a wide variety of economic problems, develop theories to explain causes of these problems, and identify possible solutions.

Economics provides both a general academic experience and professional preparation. The program emphasizes economic analysis, institutions, and policy in America, regional, and urban settings. Economics is designed to facilitate the student's matriculation to the four-year college or to provide an understanding of the economic world in which we live. Key concepts and methodology for analysis are emphasized.

Career Opportunities

Budget Analyst, Business Analyst, Business Forecaster, Commodity Economist, Commodity Price Forecaster, Economic Analyst, Economic Forecaster, Economist, Industrial Relations Specialist, Investment Analyst

Faculty

Peter Allan - Emeritus | Henry Young

Degrees and Certificates Awarded

Associate in Arts, Liberal Arts

Associate Degree

No Associate degree is offered with a major in Economics. Economics courses may be used to fulfill requirements for an Associate in Arts degree with a major in Liberal Arts. See Liberal Arts for degree requirements for this major.

Transfer

For the most up-to-date information on these programs and others, visit www.assist.org. Please stop by the Transfer Center in Building 55 or make an appointment with a counselor if you have questions.

- **California State University, San Bernardino:** *Economics major*
- **University of California, Riverside:** *Economics major*

Economics Courses

ECON 101 PRINCIPLES OF ECONOMICS: MACRO

Units: 3.0 **CSU, UC** | 48-54 hours lecture

(Prerequisite: Math 90 or higher with a grade "C" or better).

Introduction to economic theory and analysis with emphasis on fiscal and monetary policy, capitalism, national income, employment, money, economic stability, economic growth and achievements emphasizing the macro-economic approach. The purpose is to provide students with an introduction into major issues facing the world economies, exposing students to the methods that economists use to study and solve those issues and economic policy problems of the 21st century.

ECON 102 PRINCIPLES OF ECONOMICS: MICRO

Units: 3.0 **CSU, UC** | 48-54 hours lecture

(Prerequisite: Math 90 or higher with a grade "C" or better).

This is an introductory course in economics focusing on choices of individual decision-makers. Topics include scarcity, specialization and trade, supply and demand market equilibrium, taxation, elasticity, consumer choice, production and cost theory and market structure profit maximization models.

ECON 128 SPECIAL TOPICS

See Special Topics listing (Variable units) **CSU**

ECON 129 INDEPENDENT STUDY

See Independent Study listing (1-3 units) **CSU**

Education

The Department of Education and Educational Technology at Victor Valley College offers certificate programs for transfer into teaching credential programs offered at accredited four-year colleges. These preparatory courses may transfer to Education and Educational Technology majors when and where articulation agreements exist. Education is the career field for those individuals who desire to teach in elementary and secondary schools, as well as in colleges and professional education. This field of study prepares students to participate as teachers and learning facilitators. Graduates in this field—bachelor's degree and postgraduate study required—qualify for a variety of positions including teaching at the elementary, secondary, and college levels. Education remains on the national list of growing occupations.

To obtain a California teaching credential, students must follow a five-year program by first pursuing a four-year bachelor's degree and then completing a fifth year teaching credential program in which they complete mostly education courses, including student teaching.

Credentials - California Commission on Teacher Credentialing is responsible for setting standards for licensure of teachers and for accreditation of institutions that prepare teachers. The Commission is working toward meeting the standards set by the Senate Bill 2042. Some institutions may still be in the process of making changes to comply with the Commission's new standards. If you are thinking of a career in teaching, you should see a counselor for the latest information.

Also, spend some time at <http://www.ctc.ca.gov/credentials/teach.html> and <http://www.teachcalifornia.org/> for important, up-to-the-minute information about the teaching profession in California.

A minimum 2.6-3.0 GPA is required for acceptance into most credential programs. Minimum GPA accepted varies according to the major and the university the student chooses.

CBEST - Students will usually student teach during the last two quarters of their credential program. Before student teaching, all students must take the California Basic Educational Skills Test (CBEST). Most students take the CBEST during their junior year, a quarter or two after transfer to a university.

CSET - All Multiple Subject (K-6) candidates are required to pass the California Subject Examinations for Teachers (CSET); there are no longer waiver programs for this requirement.

Career Opportunities

Administrative Services, Elementary Teacher, ESL Teacher, High School Teacher, College Instructor, Education Consultant, Training Facilitator, Instructional Designer, Distance Learning Specialist, MGM Teacher, Physically Handicapped Teacher, Pupil Personnel Services, Reading Teacher, Special Education Teacher, Vocational Teacher

Faculty

Mike Smith

Associate Degree

No associate degree is offered with a major in Education.

Degrees and Certificates Awarded

Educational Technology Certificate

Program Learning Outcomes

A student receiving a degree or certificate in this field will be able to:

- Demonstrate an understanding of emerging classroom technologies
- Facilitate instruction in the new literacies that emerge within digital interactive learning environments

Transfer

For the most up-to-date information on these programs and others, visit www.assist.org. Please stop by the Transfer Center in Building 55 or make an appointment with a counselor if you have questions. Multiple-Subject or Single-Subject (K-12) Teaching Credential

MULTIPLE-SUBJECT (K-6) TEACHING CREDENTIAL

- **California State University, San Bernardino** - CSUSB offers multiple-subject programs in the Liberal Studies and Human Development/Child Development (Track II) majors
- **University of California, Riverside** - UCR offers multiple-subject programs in the following majors: English, Ethnic Studies, History, Human Development, Liberal Studies, Political Science, Sociology

Local Bachelors Programs offering preparation for Multiple Subjects credentials

- **Azusa Pacific University, High Desert Regional Center**: Human Development major
- **Brandman University, Victor Valley Campus**: Social Sciences major
- **University of La Verne, High Desert Campus**: Liberal Studies major

Single Subject Teaching Credential

Students pursuing a Single Subject Teaching Credential to teach a specific subject in Grades 7-12 should follow the bachelor's degree major requirements for that specific subject waiver program and complete the appropriate general education requirements. For example, a student who plans to teach English in high school should complete the transfer requirements for an English major or an English waiver and all general education transfer requirements for the specific university.

- **California State University, San Bernardino**: Art, English, English with a concentration in Communication Studies, English with a concentration in Theatre Arts, French, Health Sciences, History, Mathematics, Music, Physical Education, Political Science, Social Sciences, Spanish, any of the sciences
- **University of California, Riverside**: Biological Sciences, English, History, Mathematics, Political Science, Physical Sciences (Physics), Social Sciences

Vocational Subjects

The following California State University (CSU) campuses offer Bachelor's Degrees in Vocational Ed./Occupational Studies. Contact them for admissions requirements:

Long Beach | San Diego | Los Angeles | San Francisco | San Bernardino | San Luis Obispo

EDUCATIONAL TECHNOLOGY CERTIFICATE OF CAREER PREPARATION		
The Educational Technology Certificate Program significantly enhances transfer readiness for students who intend to pursue a career in public education (K-12 teacher, community college teacher, school administration, academic counseling, special education, etc.) or a career in professional education (instructional designer, business/corporate trainer, educational software engineer, educational consultant.) Additionally, the program (1) prepares students/teachers of all levels in the use and integration of computer technology in their practice, and (2) prepares students/teachers for work as paraprofessionals or para-educators in technology-enhanced school settings, such as computer labs and networked classrooms. The Educational Technology Certificate Program exceeds the rigorous standards set by version two of the California Technology Assessment Profile.		
Units Required: 17.0	<i>All of the following must be completed: (17 Units Maximum)</i>	
EDUC 51	Introduction to Educational Technology	3.0
EDUC 60	Introduction to Online Teaching and Learning	2.0
EDUC 101	Introduction to Teaching	3.0
EDUC 138	Cooperative Education - Education	1.0-8.0
ETEC 106	Introduction to Computer Technology for Educators	4.0

Education Courses

EDUC 51 INTRODUCTION TO EDUCATIONAL TECHNOLOGY (Formerly ETEC 51)

Units: 3.0 [CSU, UC](#) | 48-54 hours lecture

(No prerequisites)

This course examines educational technology and its roles, as well as fundamental theoretical concepts of human development, learning and performance, information and communication, instruction and instructional design. Students will analyze technology from three integrated perspectives: technology as a tool, a medium, and a setting for learning and will use internet tools as they survey a variety of strategies for integrating technology into classrooms. The course will also introduce students to basic methods for integrating technology into classroom lessons and for creating online learning activities. Students will have the opportunity to create projects relevant to their educational setting.

EDUC 60 INTRODUCTION TO ONLINE TEACHING AND LEARNING

Units: 2.0 [CSU, UC](#) | 24-27 hours lecture and 24-27 hours laboratory

(No prerequisites)

A course for education students or current teachers to acquire the skills needed to effectively create and utilize a virtual classroom, with particular emphasis on computer-mediated communication, cyber-scaffolding, construction and facilitation of learning activities, building online learning communities, managing virtual classrooms, performing formative and summative assessments, and online instructional design. The overall focus of the course will be understanding course design, best practices, and applicable theory for online teaching and learning.

EDUC 101 INTRODUCTION TO TEACHING

Units: 3.0 [CSU, UC](#) | 48-54 hours lecture

(No prerequisites)

Introduction to teaching as a career and education as a social institution. Crucial issues facing schools in American democratic society are considered, especially K-12 goals, curriculum, and methods. Opportunities, challenges, and requirements of the profession are presented. This course is not designed to be a course in professional education. A minimum 30 hours of observation/participation in public schools grades K-8 by arrangement with the instructor.

EDUC 138 COOPERATIVE EDUCATION

See Cooperative Education (1 - 8 units). [CSU](#)

Education Technology Courses

ETEC 106 INTRODUCTION TO COMPUTER TECHNOLOGY FOR EDUCATORS

Units: 4.0 [CSU](#) | 48-54 hours lecture and 48-54 hours laboratory

(No prerequisite)

A survey course which provides an overview of computer technology for multi-disciplinary majors, but with emphasis on its role in educational settings. The course provides instruction in a variety of topics supported by hands-on laboratory work with operating systems, word processing, spreadsheets, presentations, social media, and the Internet. Application and evaluation of computer technology in learning environments serves as the overall framework

Electronics and Computer Technology

The Electronics and Computer Technology Department offers several concentrations in electronics and computer technology that are designed to prepare students for a variety of high-tech job/career opportunities in the fields of engineering and technology; electronics technology; computer technology; telecommunication technology; and related technologies.

The Electronics and Computer Technology Department offers an associate degree program in engineering technology with an emphasis in electronics, computers, and telecommunications. Technology certificates offered in areas of specialization include: electronics technology, computer technology, telecommunication technology, networking technology, electronic communication technology, and industrial electronics technology. Certificates/certifications offered in specific areas of electronics, computers, and related technology include: Certified Electronics Technician (Associate CET), A+ Certified Computer Service Technician, N+ Certified Networking Technician, CISCO Certified Network Associate (CCNA), CISCO Certified Network Professional (CCNP), Microsoft Certified Systems Engineer (MCSE), Certified Fiber Optics Installer, (FOIC), Electronics Communications (WCM, FCC license) and Digital and Microprocessor Electronics.

Career Opportunities

Electronics Engineering Technologist, Computer Engineering Technologist, Network Engineering Technologist, Telecommunications Engineering Technologist, Certified Electronics Technician - CET, A+ Certified Computer Technician, N+ Certified Network Technician, Certified Telecommunication Technician, CISCO Certified Network Associate (CCNA), CISCO Certified Network Professional (CCNP), Microsoft Certified Professional (MCP), Microsoft Certified Systems Engineer (MCSE), Networking Cable Installer, Fiber Optics Installer, Microwave/Radar Technician, Laser/Optical Technician, Industrial Electronics Technician, Consumer Electronics Technician, Biomedical Instrument Technician, Audio/Visual Systems Technician, Broadcast Radio and Television, Research and Development, Sales Representative, electronics and computer equipment, Quality Control Technician,

Faculty

Khalid Rubayi

Degrees and Certificates Awarded

Associate in Science, Electronics and Computer Technology	CISCO Networking Academy I, II, III, IV, V, VI, VII Certificate
Associate in Science, Electronics Engineering Technology	Computer Technology Certificate
Associate Degree Electronics Engineering Technology Certificate	Digital Electronics Certificate
A+ Certification Examination Preparation Certificate	Electronics Technology Certificate

Program Learning Outcomes

A student receiving a degree or certificate in this field will be able to:

- Apply principles of mathematics and applied science, to perform technical calculations and solve technical problems of the types commonly encountered in electronics and computer technology careers.
- Function competently in a laboratory setting, making measurements, operating technical equipment, critically examining experimental results, and properly reporting on experimental results, including their potential for improvement.
- Use modern computational tools for technical problem solving, including scientific calculators, computers, and appropriate software.
- Recognize the need for life-long learning and possess the skills to maintain and improve technical and non-technical abilities.
- Demonstrate an ability to communicate and function effectively with members of multidisciplinary teams from a variety of backgrounds.
- Demonstrate an ability to utilize computer software applications used in electronics and computer technology such as but not limited to: MultiSim, MathCad, Packet Tracer, LabView and basic programming.

Electronics and Computer Technology

Associate Degree

To earn an Associate in Science degree with a major in Electronics and Computer Technology (07558), complete a minimum of 18 units from any of the certificate requirements or from any Electronics and Computer Technology courses and meet all Victor Valley College graduation requirements. ELCT 138 (Cooperative Education) may be used as elective credit, but may not be used to fulfill major requirements.

To earn an Associate in Science degree with a major in Electronics Engineering Technology complete the requirements specified and all other Victor Valley College graduation requirements.

Transfer

Most Electronics and Computer Technology courses transfer as Electives or fulfill subject credit requirements. Students in this field sometimes choose to pursue a bachelor's degree in technology fields such as Industrial Technology at California State Polytechnic University, San Luis Obispo, or Engineering Technology at California State Polytechnic University, Pomona. Other students choose to pursue an Engineering degree which requires a more intense curriculum in mathematics, chemistry, and physics. See Engineering for transfer requirements.

Campuses that offer Electronics and Computer Technology majors include: CSU - Chico, Fullerton, Long Beach, Pomona and Sacramento. Visit www.assist.org for major preparation requirements.

Electronics and Computer Technology

ELECTRONICS ENGINEERING TECHNOLOGY, AS AND CERTIFICATES		
Professional Preparation		
Units Required: : 52.0 – 58.0		
<i>All of the following must be completed:</i>		
ELCT 131	DC Circuit Theory and Analysis	4.0
ELCT 132	AC Circuit Theory and Analysis	4.0
ELCT 133	Solid State Devices and Circuits	4.0
ELCT 134	Solid State Circuit Analysis	4.0
ELCT 50	A+ Operating Systems Technologies	4.0
ELCT 51	C++ Programming for Electronics and Computer Technology	4.0
ELCT 71	Principles of Digital Logic and Circuits	4.0
ELCT 73	Microprocessor Principles	4.0
<i>One of the following two groups must be completed:</i>		
Electronics Emphasis (AS-07557) (Cert - 20539)		
ELCT 53	Electronic Communication Principles	4.0
ELCT 54	Electronic Communication Systems	4.0
Computer Emphasis (AS-10797) (Cert - 20540)		
ELCT 61	Basic Maintenance of Personal Computers	4.0
ELCT 77A	Networking Technology and Practices I	4.0
Individualized instruction courses require 108 hours of supervised laboratory activities.		
<i>All of the following must be completed:</i>		
ELCT 57	Technical Mathematics for Electronics I	3.0
ELCT 58	Technical Mathematics for Electronics II	3.0
ELCT 59	Technical Calculus for Electronics I	3.0
ELCT 60	Technical Calculus for Electronics II	3.0
<i>Students planning to transfer to an Electrical engineering program should take the following mathematics courses (instead of ELCT 57, 58, 59, and 60)</i>		
MATH 105	College Algebra	4.0
MATH 104	Trigonometry	4.0
MATH 226	Analytic Geometry and Calculus	5.0
MATH 227	Analytic Geometry and Calculus	5.0
<i>Complete all other General Education, proficiency and graduation requirements for the A.S. degree</i>		

Electronics and Computer Technology

COMPUTER TECHNOLOGY CERTIFICATE OF ACHIEVEMENT (07560)

Professional Preparation

Units Required: : 44.0

All of the following must be completed:

ELCT 131	DC Circuit Theory and Analysis	4.0
ELCT 132	AC Circuit Theory and Analysis	4.0
ELCT 133	Solid State Devices and Circuits	4.0
ELCT 134	Solid State Circuit Analysis	4.0
ELCT 50	A+ Operating Systems Technologies	4.0
ELCT 57	Technical Mathematics for Electronics I	3.0
ELCT 58	Technical Mathematics for Electronics II	3.0
ELCT 61	Basic Maintenance of Personal Computers	4.0
ELCT 71	Principles of Digital Logic and Circuits	4.0
ELCT 73	Microprocessor Principles	4.0

Career Option - 6 Units

Career specialty options include individualized instruction courses that are designed to provide the student with skills and/or knowledge in a specific area of digital/microprocessor technology. Supervised time will be spent with computers, audiovisual material, and laboratory equipment to meet specific objectives. Each specialty course requires 108 hours to complete, or an average of 6 hours per week.

One of the following career options must be completed:

Option 1: Microprocessor Systems

ELCT 91	Microprocessor Interfacing	3.0
ELCT 92	Microprocessor Applications	3.0

Option 2: Computer Systems

ELCT 62	PC Servicing	3.0
ELCT 63	PC Troubleshooting	3.0

CISCO NETWORKING ACADEMY CERTIFICATE LEVEL I CERTIFICATE OF CAREER PREPARATION

Units Required: : 17.0

All of the following must be completed:

ELCT 50	A+ Operating Systems Technologies	4.0
ELCT 61	Basic Maintenance of Personal Computers	4.0
ELCT 69	Network Topologies and Cabling	2.0
ELCT 80	Fiber Optics Cabling	3.0
ELCT 78A	Network Fundamentals	4.0

CISCO NETWORKING ACADEMY CERTIFICATE LEVEL II CERTIFICATE OF CAREER PREPARATION

Units Required: : 17.0

All of the following must be completed:

ELCT 50	A+ Operating Systems Technologies	4.0
ELCT 61	Basic Maintenance of Personal Computers	4.0
ELCT 69	Network Topologies and Cabling	2.0
ELCT 80	Fiber Optics Cabling	3.0
ELCT 78B	Routing Protocols and Concepts	4.0

CISCO NETWORKING ACADEMY CERTIFICATE LEVEL III CERTIFICATE OF CAREER PREPARATION

Units Required: : 17.0

All of the following must be completed:

ELCT 50	A+ Operating Systems Technologies	4.0
ELCT 61	Basic Maintenance of Personal Computers	4.0
ELCT 69	Network Topologies and Cabling	2.0
ELCT 80	Fiber Optics Cabling	3.0
ELCT 78C	LAN Switching and Wireless	4.0

CISCO NETWORKING ACADEMY CERTIFICATE LEVEL IV CERTIFICATE OF CAREER PREPARATION

Units Required: : 17.0

All of the following must be completed:

ELCT 50	A+ Operating Systems Technologies	4.0
ELCT 61	Basic Maintenance of Personal Computers	4.0
ELCT 69	Network Topologies and Cabling	2.0
ELCT 80	Fiber Optics Cabling	3.0
ELCT 78D	Accessing the WAN	4.0

CISCO NETWORKING ACADEMY CERTIFICATE LEVEL V CERTIFICATE OF CAREER PREPARATION

Units Required: : 17.0

All of the following must be completed:

ELCT 50	A+ Operating Systems Technologies	4.0
ELCT 61	Basic Maintenance of Personal Computers	4.0
ELCT 69	Network Topologies and Cabling	2.0
ELCT 80	Fiber Optics Cabling	3.0
ELCT 78E	Advanced Network Routing	4.0

CISCO NETWORKING ACADEMY CERTIFICATE LEVEL VI CERTIFICATE OF CAREER PREPARATION

Units Required: : 17.0

All of the following must be completed:

ELCT 50	A+ Operating Systems Technologies	4.0
ELCT 61	Basic Maintenance of Personal Computers	4.0
ELCT 69	Network Topologies and Cabling	2.0
ELCT 80	Fiber Optics Cabling	3.0
ELCT 78F	Implementing Secure Converged Wide-Area Networks	4.0

CISCO NETWORKING ACADEMY CERTIFICATE LEVEL VII CERTIFICATE OF CAREER PREPARATION

Units Required: : 17.0

All of the following must be completed:

ELCT 50	A+ Operating Systems Technologies	4.0
ELCT 61	Basic Maintenance of Personal Computers	4.0
ELCT 69	Network Topologies and Cabling	2.0
ELCT 80	Fiber Optics Cabling	3.0
ELCT 78G	Building Multilayer Switched Networks	4.0

Electronics and Computer Technology

DIGITAL ELECTRONICS CERTIFICATE OF ACHIEVEMENT (07561)		
Units Required: : 30.0		
<i>All of the following must be completed:</i>		
ELCT 131	DC Circuit Theory and Analysis	4.0
ELCT 132	AC Circuit Theory and Analysis	4.0
ELCT 133	Solid State Devices and Circuits	4.0
ELCT 134	Solid State Circuit Analysis	4.0
ELCT 57	Technical Mathematics for Electronics I	3.0
ELCT 58	Technical Mathematics for Electronics II	3.0
ELCT 71	Principles of Digital Logic and Circuits	4.0
ELCT 73	Microprocessor Principles	4.0
ELECTRONICS TECHNOLOGY CERTIFICATE OF ACHIEVEMENT (10798)		
Units Required: : 36.0		<i>Career Preparation</i>
<i>All of the following must be completed:</i>		
ELCT 131	DC Circuit Theory and Analysis	4.0
ELCT 132	AC Circuit Theory and Analysis	4.0
ELCT 133	Solid State Devices and Circuits	4.0
ELCT 134	Solid State Circuit Analysis	4.0
ELCT 57	Technical Mathematics for Electronics I	3.0
ELCT 58	Technical Mathematics for Electronics II	3.0
ELCT 71	Principles of Digital Logic and Circuits	4.0
ELCT 73	Microprocessor Principles	4.0
Career Option - 6 Units		
Career specialty options are individualized instruction courses and are designed to provide the student with skills and/or knowledge in a specific area of Electronics technology. Supervised time will be spent with computers, audiovisual material, and laboratory equipment to meet specific objectives. Each specialty option requires 108 hours to complete, or an average of 6 hours per week.		
<i>One of the following career options must be completed:</i>		
Option 1: Optoelectronics		
ELCT 85	Optoelectronics: Fiber Optics	3.0
ELCT 86	Optoelectronics: Lasers	3.0
Option 2: Telecommunications		
ELCT 97	Telecommunications: Digital Communications	3.0
ELCT 99	Telecommunications: Microwave Communications	3.0
Option 3: Television and Video Systems		
ELCT 93	TV Servicing	3.0
ELCT 94	VCR/Camcorder Servicing	3.0
Option 4: Industrial Electronics		
ELCT 87	Industrial electronics: Industrial Control Systems	3.0
ELCT 88	Industrial electronics: Industrial Process Control Applications	3.0
Option 5: Biomedical Electronics		
ELCT 89	Biomedical Instrumentation	3.0
ELCT 90	Advanced Biomedical Instrumentation	3.0

Electronics and Computer Technology

MICROSOFT CERTIFIED SYSTEMS ENGINEER (MCSE) EXAMINATION PREPARATION CERTIFICATE LEVEL I - CERTIFICATE OF CAREER PREPARATION

Units Required: 14.0		
<i>All of the following must be completed:</i>		
ELCT 50	A+ Operating Systems Technologies	4.0
ELCT 61	Basic Maintenance of Personal Computers	4.0
ELCT 69	Network Topologies and Cabling	2.0
ELCT 79A	Microsoft Certified Systems Engineer	4.0

MICROSOFT CERTIFIED SYSTEMS ENGINEER (MCSE) EXAMINATION PREPARATION CERTIFICATE LEVEL II - CERTIFICATE OF CAREER PREPARATION

Units Required: 14.0		
<i>All of the following must be completed:</i>		
ELCT 50	A+ Operating Systems Technologies	4.0
ELCT 61	Basic Maintenance of Personal Computers	4.0
ELCT 69	Network Topologies and Cabling	2.0
ELCT 79B	Microsoft Certified Systems Engineer II	4.0

NETWORK CABLING TECHNICIAN CERTIFICATE OF CAREER PREPARATION

Units Required: 16.0		
<i>All of the following must be completed:</i>		
ELCT 131	DC Circuit Theory and Analysis	4.0
ELCT 57	Technical Mathematics for Electronics I	3.0
ELCT 132	AC Circuit Theory and Analysis	4.0
ELCT 58	Technical Mathematics for Electronics II	3.0
ELCT 69	Network Topologies and Cabling	2.0

FIBER OPTIC CABLING TECHNICIAN CERTIFICATE OF CAREER PREPARATION

Units Required: 17.0		
<i>All of the following must be completed:</i>		
ELCT 131	DC Circuit Theory and Analysis	4.0
ELCT 57	Technical Mathematics for Electronics I	3.0
ELCT 132	AC Circuit Theory and Analysis	4.0
ELCT 58	Technical Mathematics for Electronics II	3.0
ELCT 80	Fiber Optics Cabling	3.0

A+ CERTIFICATION EXAMINATION PREPARATION CERTIFICATE OF CAREER PREPARATION

Units Required: 15.0		
<i>All of the following must be completed:</i>		
ELCT 50	A+ Operating Systems Technologies	4.0
ELCT 61	Basic Maintenance of Personal Computers	4.0
ELCT 65	PC Monitors	3.0
ELCT 69	Network Topologies and Cabling	2.0
ELCT 7	A+ Certification Exam Preparation	2.0

Electronics and Computer Technology

N+ CERTIFICATION EXAMINATION PREPARATION CERTIFICATE OF CAREER PREPARATION

Units Required: 17.0

All of the following must be completed:

ELCT 50	A+ Operating Systems Technologies	4.0
ELCT 61	Basic Maintenance of Personal Computers	4.0
ELCT 77A	Networking Technology and Practices I	4.0
ELCT 69	Network Topologies and Cabling	2.0
ELCT 80	Fiber Optics Cabling	3.0

WIRELESS COMMUNICATION TECHNOLOGY CERTIFICATE OF CAREER PREPARATION

Units Required: 38.0

All of the following must be completed:

ELCT 131	DC Circuit Theory and Analysis	4.0
ELCT 132	AC Circuit Theory and Analysis	4.0
ELCT 133	Solid State Devices and Circuits	4.0
ELCT 134	Solid State Circuit Analysis	4.0
ELCT 53	Electronic Communication Principles	4.0
ELCT 54	Electronic Communication Systems	4.0
ELCT 57	Technical Mathematics for Electronics I	3.0
ELCT 58	Technical Mathematics for Electronics II	3.0
ELCT 71	Principles of Digital Logic and Circuits	4.0
ELCT 73	Microprocessor Principles	4.0

Electronics and Computer Technology Courses

ELCT 7 A+ CERTIFICATION EXAMINATION PREPARATION

Units: 2.0 | **64-72 hours individualized instruction**

(No prerequisite) This course does not apply to the Associate Degree.

The A+ Certification examination preparation course is designed to test student knowledge with an extensive set of questions, discussions and simulations to further enhance and sharpen student technical skills prior to taking the CompTIA A+ exam. The course thoroughly tests student knowledge based on the A+ outlined exam objectives which include: Personal Computer (PC) hardware, operating systems, PC troubleshooting, networking, printers, and other important and related topics such as safety and customer service.

ELCT 50 A+ OPERATING SYSTEMS TECHNOLOGIES

Units: 4.0 | **48-54 hours lecture and 48-54 hours laboratory**

(No prerequisite)

This course is designed to prepare students to take the A+ Operating Systems Technologies Examination. Topics include operating system fundamentals; Windows 2000, Windows XP and Windows XP Media Edition; installing, configuring and upgrading windows; diagnosing, troubleshooting common problems; dual booting, registry editing, command line troubleshooting; network capabilities, configuring and connecting to resources and networks on the client side.

ELCT 57 TECHNICAL MATHEMATICS FOR ELECTRONICS I

Units: 3.0 | **48-54 hours lecture**

(No prerequisite)

This course is designed to provide a basis for a clear mathematical understanding of the principles of DC electricity and electronics and their analysis. Covered are algebra, equations, power of 10, units and dimensions, special products and factoring, algebraic fractions, fractional equations, graphs, simultaneous equations, determinants and matrices, exponents and radicals, and quadratic equations.

ELCT 58 TECHNICAL MATHEMATICS FOR ELECTRONICS II

Units: 3.0 | **48-54 hours lecture or 96-108 hours Individualized Instruction**

(No prerequisite)

This course is designed to provide a basis for a clear mathematical understanding of the principles of AC electricity and electronics and their analysis. Covered are inequalities, series, angles, trig functions, solution of right triangles, trig identities and equations, plane vectors, periodic functions, phasor algebra, and logarithms.

ELCT 59 TECHNICAL CALCULUS FOR ELECTRONICS I

Units: 3.0 | **48-54 hours lecture or 96-108 hours Individualized Instruction**

(No prerequisite)

This course is designed for students who are preparing for careers in electronics, electricity, computers, and related technical fields. Topics include: Introduction to Calculus for Electronics, Functions, Rates, Limits, Derivatives, Graphical Application of the Derivative, Differentiation, Trigonometric, Logarithmic and Exponential Functions, First-Order Linear Differential Equation, Maximum, Minimum, and Inflection Points.

ELCT 60 TECHNICAL CALCULUS FOR ELECTRONICS II

Units: 3.0 | **48-54 hours lecture or 96-108 hours Individualized Instruction**

(No prerequisite)

This course in technical calculus for electronics continues the study of functions and further operations. Topics includes trig functions, logarithmic and exponential functions, hyperbolic functions, partial derivatives, integration techniques, double integrals, infinite series, MacLaurin series, Taylor series, Fourier series, and introduction to differential equations.

Electronics and Computer Technology Courses

ELCT 61 BASIC MAINTENANCE OF PERSONAL COMPUTERS

Units: 4.0

48-54 hours lecture and 48-54 hours laboratory

(No prerequisite)

This hands-on course is designed to provide non-technical personal computer (PC) users with the skills necessary to service and upgrade PCs. Activities include: computer assembly and disassembly, disk drive removal and installation, and memory expansion with integrated circuit (IC) chips. Installation and check out of special functions boards, such as FAX/modem, also will be demonstrated. Lectures describing the PC and its components are augmented with computer-aided individualized instruction modules covering selected electronic principles related to the PC. Satisfies computer industries A+ certification requirements.

ELCT 71 PRINCIPLES OF DIGITAL LOGIC AND CIRCUITS

Units: 4.0

48-54 hours lecture and 48-54 hours laboratory

(No prerequisite)

This course will introduce students to digital logic circuits. Students will cover basic concepts in digital electronics, and discrete digital components. Hands-on lab will cover steps to build, verify and troubleshoot digital circuits with emphasis on practical applications and proper use of test equipment. Topics include binary systems, logic gates, combinational logic, synchronous sequential logic. Flip-Flops, asynchronous sequential logic, register, counters, memory, and digital integrated circuits.

ELCT 73 MICROPROCESSOR PRINCIPLES

Units: 4.0

48-54 hours lecture and 48-54 hours laboratory

(No prerequisite)

Introduction to the principles of microprocessor design, topics include microprocessor architecture, bus architecture, memory (R/W Memory, ROM, EPROM, and EEPROM) maps, I/Os, interfacing devices, introduction to the instruction set of the microprocessor, assembly language programming techniques, introduction to various I/O techniques such as parallel I/O, serial I/O and interrupts. Laboratory projects include emphasis on designing and building microprocessor-based systems and hardware interfacing.

ELCT 76 MICROPROCESSOR INTERFACING AND APPLICATIONS

Units: 4.0

48-54 hours lecture and 48-54 hours laboratory

(No prerequisite)

Development of microprocessor based systems for embedded applications. Topics include Interfacing to input/output peripherals such as displays, keypads, sensors, digital-to-analog and analog-to-digital converters, and communication devices among others. Laboratory component is an integral part of this course emphasizing a hands-on approach for students to design, build, and test embedded micro-controller systems.

ELCT 78A NETWORK FUNDAMENTALS

Units: 4.0

48-54 hours lecture and 48-54 hours laboratory

(No prerequisite)

The goal of this course is to introduce students to fundamental networking concepts and technologies. It will assist students in developing the skills necessary to plan implement small networks across a range of applications. Topics include OSI and TCP/IP models, different network topologies, IP addressing and sub-netting. Satisfies Cisco Certified Network Associate (CCNA) certification exam requirements.

ELCT 78B ROUTING PROTOCOLS AND CONCEPTS

Units: 4.0

48-54 hours lecture and 48-54 hours laboratory

(No prerequisite)

This course describes the architecture, components, and operation of routers, and explains the principles of routing and routing protocols. Students with hands-on approach will be able to analyze, configure, verify and troubleshoot routing protocols RIPv1, RIPv2, EIGRP, and OSPF. Satisfies Cisco Certified Network Associate (CCNA) certification exam requirements.

Electronics and Computer Technology Courses

ELCT 78C LAN SWITCHING AND WIRELESS

Units: 4.0

48-54 hours lecture and 48-54 hours laboratory

(No prerequisite)

This course provides a comprehensive and practical approach to learning the technologies and protocols needed to design and implement a converged switched network. Students will learn how to select network devices for each layer. The course explains how to configure a switch and how to implement Virtual LANs, VTP, Inter-VLAN routing. It also discusses the implementations of Spanning Tree Protocol. Students will develop the skills necessary to implement a Wireless LAN in a small to medium network. Satisfies Cisco Certified Network Associate (CCNA) certification exam requirements.

ELCT 78D ACCESSING THE WAN

Units: 4.0

48-54 hours lecture and 48-54 hours laboratory

(No prerequisite)

This course discusses the Wide Area Network (WAN) technologies and network services required to gain access outside the Local Area Network (LAN). Students learn in a hands-on approach how to implement and configure different technologies to access the WAN. Topics include Point-to-Point Protocol (PPP), Frame Relay, Network Security, Access Control Lists (ACLs), Virtual Private Networks (VPN), Network Address Translation (NAT) DHCP and IPv6. Satisfies Cisco Certified Network Associates (CCNA) certification exam requirements.

ELCT 78E ADVANCED NETWORK ROUTING

Units: 4.0

48-54 hours lecture and 48-54 hours laboratory

(No prerequisite)

This course is the first of a four course series designed to prepare students towards the Cisco Certified Network Professional (CCNP) certification. It introduces students to advanced IP address management, scaling IP networks, IP addressing using VLSM, private addressing, and NAT to optimize address utilization. Majority of the course deals with advanced topics in configuring routing protocols (RIPv2, EIGRP, ISIS, multi-area OSPF, and BGP), also covers important topics and techniques for route filtering, route optimization and route redistribution.

ELCT 78F IMPLEMENTING SECURE CONVERGED WIDE-AREA NETWORKS

Units: 4.0

48-54 hours lecture and 48-54 hours laboratory

(No prerequisite)

This is the second course of a four course series designed to prepare students for Cisco's (CCNP) certification. This course will cover advanced topics in Wide Area Network (WAN). Students learn with hands-on approach how to configure and implement different WAN technologies with focus on VPN configuration and securing network access. Topics include teleworker configuration and access, frame-mode MPLS, site-to-site IPSEC VPN, Cisco EZVPN, strategies used to mitigate network attacks, Cisco device hardening and IOS firewall features.

ELCT 78G BUILDING MULTILAYER SWITCHED NETWORKS

Units: 4.0

48-54 hours lecture and 48-54 hours laboratory

(No prerequisite)

This is the third of a four course series designed to prepare students for Cisco's (CCNP) certification. This course will cover advanced topics in building Multilayer Switched Networks. Students learn with hands-on approach how to deploy state-of-the-art campus LANs. Topics include VLANs, Spanning Tree Protocol (STP), VTP, Inter-VLAN Routing, Layer three Switches, Wireless Client Access, Voice over IP (VoIP) Switch Configuration, Redundancy and Fault Tolerance.

ELCT 78H OPTIMIZING AND TROUBLESHOOTING NETWORKS

Units: 4.0

48-54 hours lecture and 48-54 hours laboratory

(No prerequisite)

This is the fourth and last course of a four course series designed to prepare students for Cisco's CCNP certification. This course will cover advanced topics in optimizing and troubleshooting converged networks. Students learn with hands-on approach how to implement, optimize and troubleshoot networks operating voice, wireless and security applications. Topics include implementing a Voice over IP (VoIP) network, implementing Quality of Services (QoS) on converged networks, specific IP QoS mechanisms for implementing the DiffServ QoS model, AutoQoS, wireless security and basic wireless management.

Electronics and Computer Technology Courses

ELCT 78I FUNDAMENTALS OF NETWORKING SECURITY

Units: 4.0

48 hours lecture and 48 hours laboratory

(No prerequisite)

The curriculum provides an introduction to the core security concepts and skills needed for the installation, troubleshooting, and monitoring of network devices to maintain the integrity, confidentiality, and availability of data and devices. It provides students with both the technical knowledge and skill experience through extensive hands-on experience needed to prepare for entry-level security specialist careers. The curriculum aims to provide students with hands-on experience with Cisco routers, switches, PIX, ASA security appliance and to develop in-depth understanding of network security principles and tools such as: protocol sniffers/analyzers, Cisco IOS Software, and Cisco VPN client. The curriculum is designed to prepare students for the CCNA Security Certification, which is recognized, by the National Security Agency (NSA) and the Committee on National Security Systems (CNSS) to meet CNSS 4011 training standard.

ELCT 78J FUNDAMENTALS OF WIRELESS LANS

Units: 4.0

48-54 hours lecture and 48-54 hours laboratory

(No prerequisite)

This course focuses on the design, installation, configuration, operation and troubleshooting of 802.11a, 802.11b, 802.11g, 802.11n wireless LANs. It delivers a comprehensive overview in a hands-on lab environment of wireless technologies, security, design, and best practices with emphasis on real world applications and case studies. Topics include wireless radio technology, wireless topologies, antennas, access points, bridges, wireless security, Guest VLAN, site survey, installation, management, diagnostic tools, monitoring, and discussions on wireless emerging technologies. It also prepares students towards obtaining Cisco Wireless LAN Support Specialist certificate.

ELCT 78K VOICE OVER IP (VoIP) FOUNDATIONS

Units: 4.0

48-54 hours lecture and 48-54 hours laboratory

(No prerequisite)

This course provides a practical hands-on approach to Voice over IP (VoIP) implementation. Topics include Internet Protocol carries a VoIP packet, configuring DHCP and DNS for supporting IP telephony, Real-Time Transport Protocol, Session Initiation Protocol, call set up, Instant Messaging, Presence, Session Description Protocol, and the H.323 protocol suite, gatekeepers, gateways, Media Gateway Control Protocol and architecture, comparing H.323, SIP, and MGCP, implementing QoS for the highest possible voice quality over IP networks, and how jitter, latency, and packet loss impact VoIP networks, troubleshooting RTP, MGCP, SIP, and H.323 call flows, and softphones, and security considerations for VoIP setups. Lab is an important and integral part of this course; student will train on Cisco routers and switches to implement VoIP and CallManager.

ELCT 85 OPTOELECTRONICS: FIBER OPTICS

Units: 3.0

144-162 hours laboratory or 96-108 hours individualized instruction

(No prerequisite)

This hands-on self-paced course will provide students with the fundamentals of optical fiber, connectors, couplers, and other components and their application within a fiber optic system. Through hands-on LABs, students will learn key characteristics and principals of operation for critical electro-optic components such as LED's, lasers and detectors. In addition students will cover the operation of transmitters, receivers, and fiber optic communication systems with special emphasis on digital data links and fiber video links. In the LAB students will acquire skills to inspect, install and test connectors using the epoxy polish method, identify damage to cables and associated causes, Test fiber optic cable for losses, fiber cable splicing, optical performance, communications and systems.

ELCT 87 INDUSTRIAL ELECTRONICS: INDUSTRIAL CONTROL SYSTEMS, DEVICES AND CIRCUITS

Units: 3.0

96-108 hours individualized instruction

(No prerequisite)

This course is designed to provide the student an opportunity to study a wide range of applications of electronics found in industrial automation and robotics. Topics include: operational amplifiers, linear integrated circuits, generators and motors, control devices and circuits, transducers, programmable logic controllers (PLCs), PLC functions, ladder logic, programming and applications.

Electronics and Computer Technology Courses

ELCT 110 ELECTRONICS AND COMPUTER TECHNOLOGY

Units: 3.0 **CSU** | 48-54 hours lecture

(No prerequisite)

This course is designed to expose students to a wide range of electronics and computer technologies in a simplified, practical and non-mathematical hands-on approach. Topics will include electronics and computers applied to automotive and medical fields, global positioning satellites (GPS), home entertainment systems, surround sound and digital flat panel TVs, digital music compression and recording, Internet, wireless and wired networking in the house, computer hardware setup and operation, how to use personal computer (PC) applications, basic PC diagnostics, upgrade and troubleshooting.

ELCT 131 D.C. CIRCUIT THEORY AND ANALYSIS

Units: 4.0 **CSU** | 48-54 hours lecture and 48-54 hours laboratory

(No prerequisite)

Introduction to DC circuits analysis, a theoretical and practical hands-on approach to DC fundamentals. Topics include Ohm's Law, Series, Parallel and Series-Parallel Circuits, Network Theorems, Methods of Analysis, Equivalent Circuits, Capacitive and Inductive Circuits, Timing Circuits, Measuring Instruments, Magnetism and Magnetic Circuits. A laboratory component is an integral part of this course emphasizing a hands-on approach for students to use different test instruments and software tools to design, build, test, and analyze DC circuits.

ELCT 132 A.C. CIRCUIT THEORY AND ANALYSIS

Units: 4.0 **CSU** | 48-54 hours lecture and 48-54 hours laboratory

(No prerequisite)

Introduction to AC circuits analysis, a theoretical and practical hands-on approach to AC fundamentals. Topics include AC waveform analysis, Inductive and Capacitive Circuits, Impedance, Power in AC Circuits, AC Series-Parallel Circuits Design, Methods of AC Analysis, AC Network Theorems, Resonance, and Filters. A laboratory component is an integral part of this course emphasizing a hands-on approach for students to use different test instruments and software applications to design, build, test, and analyze AC circuits.

ELCT 133 SOLID STATE DEVICES AND CIRCUITS

Units: 4.0 **CSU** | 48-54 hours lecture and 48-54 hours laboratory

(No prerequisite)

This course is an introduction to Solid State Devices and circuit analysis, a theoretical and practical hands-on approach to Solid State fundamentals. Topics include Semiconductor Diodes, Bipolar Transistor Theory, DC Biasing of Bipolar Junction Transistors (BJTs), Field-Effect Transistor (FETs) Theory, FET Biasing, Circuit Design with BJT and FET Transistors, BJT and FET Small Signal Analysis, Large Signal Amplifiers, Introduction to Operational Amplifiers (Op-Amps), Linear Integrated Circuits (ICs) Regulators, Feedback Amplifiers and Oscillator Circuits. A laboratory component is an integral part of this course emphasizing a hands-on approach for students to use different test instruments and software tools to design, build, test, and analyze Solid State circuits.

ELCT 134 SOLID STATE CIRCUIT ANALYSIS

Units: 4.0 **CSU** | 48-54 hours lecture and 48-54 hours laboratory

(No prerequisite)

This course is an introduction to Operational Amplifiers, a theoretical and practical hands-on approach to Op-Amps and Linear Integrated Circuit design and analysis. Topics include Differential Amplifiers, Operational Amplifiers, Op-Amp with Negative Feedback, Frequency Response of an Op-Amp, Active Filters and Oscillators, Comparators, General Linear Applications, and Specialized Applications. Laboratory component is an integral part of this course emphasizing a hands-on approach for students to use different test instruments and software tools to design, build, test, and analyze various Op-Amps and Linear Integrated circuits.

ELCT 138 COOPERATIVE EDUCATION

See Cooperative Education. Units: 1 - 8 units **CSU**

Electronics and Computer Technology Courses

ELCT 202 COMPUTER METHODS FOR ENGINEERS

Units: 4.0 **CSU** | 48-54 hours lecture and 48-54 hours laboratory

(Prerequisite: MATH 227 or MATH H227 minimum grade C.)

This course is an introduction to methods and techniques for solving engineering problems using numerical-analysis computer-application programs, technical computing and visualization using MATLAB software. The course is structured to allow students to have a thorough hands-on experience with examples and exercises applied to a wide variety of practical engineering problems.

ELCT 210 ENGINEERING CIRCUIT ANALYSIS I

Units: 4.0 **CSU** | 48-54 hours lecture and 48-54 hours laboratory

(Prerequisite: PHYS 203 and MATH 226 or MATH H226 minimum grade C.)

Introduction to engineering circuit analysis, topics include Ohm's Law, Series, Parallel and Series-Parallel Circuits, Network Theorems, Methods of Analysis, Mesh Equations, Equivalent Circuits, Capacitive and Inductive Circuits, First-Order Circuits, Timing Circuits, Measuring Instruments, Magnetism and Magnetic Circuits, Introduction to Electromagnetic radiation and Electric Machinery. Laboratory experiments and the use of Computer Aided Circuit Analysis software (MultiSim and MATLAB) is an integral part of the course to supplement classroom lectures.

ELCT 211 ENGINEERING CIRCUIT ANALYSIS II

Units: 4.0 **CSU** | 48-54 hours lecture and 48-54 hours laboratory

(Prerequisite: ELCT 210 minimum grade C)

Introduction to engineering circuit analysis II, topics include analysis of RLC passive networks in response to single and multiple sinusoidal, ramp, and pulse sources, Network Theorems, Impedance, Power in AC circuits, Methods of AC analysis, Second-Order circuits, Sinusoidal Steady-State, The Laplace Transform, Fourier analysis, Two-Port Networks, Resonance and Filters. Laboratory experiments and the use of Computer Aided Circuit Analysis software (MultiSim and MATLAB) is an integral part of the course to supplement classroom lectures.

Emergency Medical Services

Victor Valley College offers two programs that enable students to enter careers in Emergency Medical Services. The first is the Emergency Medical Technician (EMT), after which students may continue to the Paramedic Program. Classes in this area meet California State EMS authority and ICEMA regulations.

Faculty

Brian Hendrickson | Scott Jones | Dave Oleson

Degrees and Certificates Awarded

Associate in Science, Emergency Medical Service
Paramedic Certificate

Emergency Medical Technician Certificate (Refresher)

Program Learning Outcomes

A student receiving a degree or certificate in this field will be able to:

- Demonstrate the ability to integrate the knowledge of injury / illness pathophysiology for all patients into a high quality of treatment and patient care.
- Apply effective leadership and communication strategies to effectively manage an emergency situation.
- Demonstrate the ability to evaluate various patient conditions and implement appropriate advanced skills based upon necessity.
- Perform at a minimum, as a competent, safe practitioner in caring for the community and the critically sick and injured

Associate Degree

To earn an A.S. degree with a major in Emergency Medical Services, complete all of the Paramedic Certificate requirements and meet all Victor Valley College graduation requirements.

Transfer

Not a transfer major. Some students pursue bachelor's degrees in related fields such as B.S. in Emergency Medical Care at Loma Linda University, B.S. in Public Safety and Emergency Management at Grand Canyon University, or B.S. In Health Administration with a concentration in Emergency Management at the University of Phoenix.

EMERGENCY MEDICAL SERVICES, AS (04980)		
To earn an A.S. degree with a major in Emergency Medical Services, complete all the following requirements outlined in the Paramedic Certificate, General Education requirements, and meet all Victor Valley College graduation requirements.		
Units Required: 40.0		
<i>All of the following must be completed with a grade of "C" or better:</i>		
EMS 80	Paramedic Anatomy and Physiology	3.5
EMS 81	Paramedic Introduction to Emergency Medical Services	3.5
EMS 82	Paramedic Cardiology	4.5
EMS 83	Paramedic Pharmacology	3.5
EMS 84	Emergency Medical Services	10.0
EMS 85	Paramedic Clinical	4.0
EMS 86	Paramedic Field Internship	11.5

Emergency Medical Services

EMERGENCY MEDICAL TECHNICIAN CERTIFICATE OF CAREER PREPARATION (Refresher)

The EMT I is the beginning level for emergency response personnel. It is the minimum preparation required to staff an ambulance.

Units Required: 1.0

All of the following must be completed with a grade of "C" or better:

EMS 61	(Ambulance) Refresher Course	1.0
--------	------------------------------	-----

PARAMEDIC CERTIFICATE OF ACHIEVEMENT (20546)

The Victor Valley College Paramedic Program is accredited by the Commission on Accreditation of Allied Health Education Programs (www.caahep.org) upon the recommendation of the Committee on Accreditation of Educational Programs for the Emergency Medical Services Professions (CoAEMSP).

Commission on Accreditation of Allied Health Education Programs
25400 U.S. Highway 19 North, Suite 158
Clearwater, FL 33763
727-210-2350 | www.caahep.org

To contact CoAEMSP:
8301 Lakeview Parkway Suite 111-312, Rowlett, TX 75088
214-703-8445 FAX 214-703-8992 | www.coaemsp.org

Units Required: 40.5

This certificate prepares students to take the state examination to practice as a paramedic.

All of the following must be completed with a grade of "C" or better:

EMS 80	Paramedic Anatomy and Physiology	3.5
EMS 81	Paramedic Introduction to Emergency Medical Services	3.5
EMS 82	Paramedic Cardiology	4.5
EMS 83	Paramedic Pharmacology	3.5
EMS 84	Emergency Medical Services	10.0
EMS 85	Paramedic Clinical	4.0
EMS 86	Paramedic Field Internship	11.5

Emergency Medical Services Courses

EMS 50 EMERGENCY MEDICAL RESPONDER

Units: 2.5 | **32-36 hours lecture 24-27 hours laboratory**

(No prerequisites) This course does not apply to the Associate Degree.

This course provides training in basic emergency care skills, including patient assessment, CPR, automated external defibrillation, use of definitive airway adjuncts, splinting, and control of bleeding.

EMS 60 EMERGENCY MEDICAL TECHNICIAN

Units: 9.5 | **120-135 hours lecture 96-108 hours laboratory**

(Prerequisite: 18 years of age before first day of class. CPR equivalent to 2015 AHA BLS for Healthcare Providers. State mandated.)

This course provides training in basic emergency care skills, including CPR, automated external defibrillation, use of definitive airway adjuncts, and assisting patients with certain medications. Approved by the Inland Counties Emergency Medical Agency. All students must be eighteen years of age and have CPR (Cardio-Pulmonary Resuscitation) training equivalent to the American Heart Association Healthcare Provider Level (Title 22, Div. 9, Ch. 2, Sect. 100066 b2 California Code of Regulations) prior to the first day of class due to current clinical/field internship affiliation agreements. (Formerly ALDH 71)

EMS 61 EMERGENCY MEDICAL TECHNICIAN REFRESHER

Units: 1.0 | **8-9 hours lecture 24-27 hours laboratory**

(Prerequisite: Current EMT license.)

Thirty hour refresher course required for renewal of Emergency Medical Technician I Certificate. New Certificate of Completion awarded. Course approved by the Inland County Emergency Medical Agency and adheres to California Code of Regulations, Title 22, Division 9, Chapter 4.

EMS 80 PARAMEDIC ANATOMY AND PHYSIOLOGY

Units: 3.5 | **48-58 hours lecture and 24-27 hours laboratory**

(Prerequisite: Application and acceptance into the Paramedic Academy and successful completion EMS 60 with a grade of "B" or better or an EMT card equivalent).

This is the introductory course of the Paramedic program. This course includes basic anatomy, physiology, and medical terminology for the paramedic.

EMS 81 PARAMEDIC INTRODUCTION TO EMERGENCY MEDICAL SERVICES

Units: 3.5 | **48-58 hours lecture and 24-27 hours laboratory**

(Prerequisite: Application and acceptance into the Paramedic Academy and successful completion of EMS 60 with a "B" grade or better or an EMT card equivalent).

This course covers the roles and responsibilities of the EMT-P. It also includes the Emergency Medical Services System and EMS communication and leadership as it relates to the EMT-P.

EMS 82 PARAMEDIC CARDIOLOGY

Units: 4.5 | **56-63 hours lecture and 48-54 hours laboratory**

(Prerequisite: Application and acceptance into the Paramedic Academy and successful completion of EMS 80 and 81.)

This course covers the cardiovascular system and includes anatomy and physiology of the heart, and application and interpretation of EKG's.

EMS 83 PARAMEDIC PHARMACOLOGY

Units: 3.5 | **48-54 hours lecture and 24-27 hours laboratory**

(Prerequisite: Application and acceptance into the Paramedic Academy and successful completion of EMS 80 and 81.)

This course will cover the general principles of Pharmacology including calculations and administration of various medications.

Emergency Medical Services Courses

EMS 84 EMERGENCY MEDICAL SERVICES (Formerly ALDH 55)

Units: 10.0

128-144 hours lecture and 96-108 hours laboratory

(Prerequisite: Application and acceptance into the Paramedic Program is required before registering for this course. Successful completion of EMS 80, 81, 82, 83 with 80% or better.)

This course covers the theoretical and scientific background of emergency medical care in the pre-hospital setting to include patient assessment, trauma and medical emergencies, and skills practice in the lab.

EMS 85 PARAMEDIC CLINICAL (Formerly ALDH 56)

Units: 4.0

192-216 hours laboratory

(Prerequisite: Application and acceptance into the Paramedic Academy and successful completion of EMS 84 with 80% or better.)

This course is the first part of the student's internship as part of the Paramedic Program. This includes lab hours at an acute care facility performing Inland Counties Emergency Medical Agency Skills.

EMS 86 PARAMEDIC FIELD INTERNSHIP (Formerly ALDH 57)

Units: 11.5

552-621 hours laboratory

(Prerequisite: Application and acceptance into the Paramedic Academy and successful completion of EMS 85 with 80% or better.)

This course is the field internship portion of the Paramedic program. Students will spend 600 hours in the field with a transport service performing Emergency Medical Technician skills.

Engineering

Victor Valley College does not offer an Engineering program for transfer, but does however offer preparatory courses needed for transfer for transfer into a School of Engineering. These course our offered through our Computer Integrated Design and Graphics (CIDG) Department. Students can obtain Engineering related certificates that will assist in preparing them to enter into a school of Engineering at the university level. An Associate of Science for Transfer degree in Mathematics is highly recommended for those students wanting to transfer into a School of Engineering. Students seeking an Associate of Science degree in CIDG are positioned to enter straight into the workforce.

Engineers seek to understand and solve a broad range of technical problems faced by our society. Engineers are responsible for such projects as converting raw materials and power sources into useful products, developing scientific equipment, and designing and planning the construction of buildings, highways, and rapid transit systems. As society becomes more technologically complex, so do the ever-emerging branches of engineering. The rigorous curriculum of engineering programs is for high achieving students who have developed good study habits and possess a strong math and science background. No associate degree is offered with a major in Engineering from Victor Valley College. Because the math and science requirements are so extensive, students usually pursue an associate degree with a major in Math/Science.

Transfer

Engineering is a highly competitive transfer degree which is impacted at many universities. There are over 200 different career fields in the Engineering area. The following courses are minimal requirements for most engineering majors: CHEM 100, 201, 202; MATH 226, 227; PHYS 201, 202, 203.

IGETC or CSU General Education-Breadth Requirements are not always appropriate for an engineering major; for the most current information, visit www.assist.org.

- UC campuses offering Engineering majors include: Berkeley, Davis, Irvine, Santa Barbara, San Diego, Santa Cruz, Riverside and Los Angeles (UCLA)
- CSU Campuses offering Engineering majors include: Dominguez Hills, Chico, Fresno, Long Beach, Los Angeles, Northridge, Pomona, Sacramento, San Diego, San Francisco, San Jose, San Luis Obispo, Sonoma, and Maritime Academy.
- Private schools offering Engineering majors include: University of Southern California (USC), Stanford, CalTech, and Harvey Mudd College

Degrees and Certificates Awarded

Associate of Science for Transfer, ADT Mathematics
Drafting Technician I Certificate
Architectural CADD Technician I Certificate

Associate in Science, CIDG
CADD I Technician I Certificate

Career Opportunities

Mechanical Engineer, CAD Operator, Chemical Engineer, Computer Engineer, Electrical Drafter, Electronics Drafter, Electrical Engineer, Mechanical Drafter, Public Works Technician, Steel Fabricator Drafter, Structural Engineer, Structural Drafter

Note: Associate of Science Degree programs require completion of at least 60 units of credit, which normally will take 4 semesters. Certificate programs, many of which lead to an Associate of Science degree, vary in the number of units required. Most can be completed in 2 - 4 semesters. Each course required for a certificate must be completed with a "C" grade or better. All can be counted toward its related degree.

English

The study of English offers students an opportunity to develop critical thinking and writing skills necessary for success in both the academic and professional worlds. It also nurtures an appreciation of the literary arts. Reading, thinking, and writing about the human experience provide a vital foundation for further education and professional success.

Since English composition courses are designed to help students write the kinds of papers commonly required in college courses, students should take English as early as possible. Follow the course sequence shown in your placement test results.

Career Opportunities

Advertising/Marketing, Analyst, Archivist, Business, Copywriter, Creative Writer, Editor, Educator, Journalist, Lobbyist, Law Clerk, Lawyer, Librarian, Management, Magazine Writer, Mixed Media, Politician/Diplomat, Professor, Proofreader, Public Relations, Researcher, Social Media, Teacher, Technical Writer, Writer

Faculty

Tim Adell | Claudia Basha - Emeritus | Bryce Campbell | Fran Ferrance - Emeritus
 Peter Francev | Andrea Glebe | Patricia Golder | Carol Golliver - Emeritus
 Joe Pendleton | Judy Solis | Karen Tomlin | Patricia Wagner

Degrees and Certificates Awarded

Associate in Arts, Liberal Arts

Associate in Arts for Transfer, English

Associate Degree

To earn an Associate in Arts degree for Transfer with a major in English, complete the required major courses and all other requirements specified on the following pages (i.e. 60 CSU transferable units, CSU GE or IGETC, etc.). For more information on the AA-T/AS-T degrees, meet with a counselor or www.adegreewithaguarantee.com

Transfer

For the most up-to-date information on these programs and others, visit www.assist.org. Please stop by the Transfer Center in Building 55 or make an appointment with a counselor if you have questions.

- **California State University, San Bernardino:** English major
- **University of California, Riverside:** English major

ENGLISH, AA-T (33082)		
Students completing an Associate in Arts in English for Transfer degree will be prepared to transfer into the CSU system to complete a baccalaureate degree in English or similar major. Upon completion of this degree, students will be able to read critically and analyze a variety of college level texts (such as non-fiction, fiction, drama, and poetry) within the conventions of language, genre, and rhetoric; analyze, evaluate, synthesize and document a variety of sources to support written arguments; draft, revise, and submit an effective essay, project, or oral presentation with attention to purpose, coherence, voice, language, and mechanical conventions.		
Program Requirements: 18-20 units		
Required Courses (6 units total)		
ENGL 102/102H	Composition and Literature	3.0
ENGL 104/104H	Critical Thinking and Writing Composition	3.0
List A –Select TWO of the following courses (6 units total)		
ENGL 230	Survey of American Literature 1600-1865	3.0
ENGL 231	Survey of American Literature 1865 to Present	3.0
ENGL 240	World Literature Ancient – Early Renaissance	3.0
ENGL 241	World Literature Renaissance - Modern	3.0
ENGL 245	Survey of British Literature Early Medieval - Neo Classics	3.0
ENGL 246	Survey of British Literature Romantics – 20th Century	3.0

ENGLISH, AA-T Continued		
List B – Select ONE (3 units)		
ENGL 220	Modern Fiction	3.0
ENGL 225	Poetry	3.0
ENGL 232	Chicano/a and Latino/a Literature	3.0
ENGL 233	African - American Literature	3.0
ENGL 234	Native American Literature	3.0
ENGL 235	Children’s Literature	3.0
ENGL 247	Shakespeare	3.0
List C – Select ONE (3 to 5 units)		
ENGL 210A	Fiction Writing	3.0
ENGL 210B	Fiction Writing II	3.0
ENGL 211A	Poetry Writing	3.0
ENGL 211B	Poetry Writing II	3.0
ASL 122	American Sign-Language I	4.0
ASL 123	American Sign-Language II	4.0
ASL 124	American Sign-Language III	4.0
ASL 125	American Sign-Language IV	4.0
FREN 101	Elementary French	5.0
FREN 102	Elementary French	5.0
FREN 103	Intermediate French	3.0
FREN 104	Intermediate French	3.0
SPAN 101	Elementary Spanish	5.0
SPAN 101A	Fundamentals of Spanish 101A	3.0
SPAN 101B	Fundamentals of Spanish 101B	3.0
SPAN 102	Elementary Spanish	5.0
SPAN 103	Intermediate Spanish	3.0
SPAN 104	Intermediate Spanish	3.0
<p>A student wishing to pursue an AA-T/AS-T degree in the major listed on this page must ensure the CSU of their choice is accepting that similar major. Students completing an AA-T/AS-T degree are guaranteed admissions into a CSU campus given that a student fulfills the following:</p> <ol style="list-style-type: none"> 1) 60 CSU transferable units; 2) Completes the CSU General Education (GE) or IGETC General Education pattern; 3) Completes the major requirements for the AA-T/AS-T; 4) Maintains a transferable cumulative GPA of at least 2.0 (C or better); 5) Completes the basic/Golden 4 GE requirements. <p>For more information on the AA-T/AS-T degrees, meet with a counselor or visit www.sb1440.org and www.adegreewithaguarantee.com</p>		

English Courses

ENGL 6 BASIC READING AND WRITING

Units: 5.0

80-90 hours lecture

(Prerequisite: BSKL 3 or eligibility as determined by the VVC assessment.) This course does not apply to the associate degree.

This is a basic writing and reading course designed to build proficiency in the basics of writing expository prose and to build reading comprehension at both literal and inferential levels.

ENGL 10.0 LABORATORY IN WRITING

Units: 1.0

48-54 hours laboratory

(No prerequisite. Pass/No Pass) This course does not apply to the Associate Degree

This lab in the Writing Center is recommended for students taking any writing-intensive course at VVC. Emphasis is on the one-to-one tutorial approach, computer-assisted instruction, and word composing/processing.

ENGL 45 WRITING FUNDAMENTALS (Formerly ENGL 50)

Units: 4.0

64-72 hours lecture

(Prerequisite: ENGL 6 minimum grade C, or eligibility as determined by VVC assessment.)

A practical writing course emphasizing expository writing, including planning, organizing, composing short essays, reading a variety of college preparatory texts, and editing for punctuation, diction, usage and sentence structure.

ENGL 61 TUTORING WRITING

Units: 3.0

48-54 hours lecture

(Prerequisite: ENGL 101.0 or ENGL 101H with a grade of 'C' or better)

This course will expose students to the theoretical concepts and practical issues involved in tutoring various levels of writing. Students will develop an understanding of the issues and practices relevant to the role of tutoring writing through observing, reading, and discussing the relationship between the writer, his/her writing, the tutor, the classroom teacher, and the classroom environment.

ENGL 62 WRITING TUTOR WORKSHOP

Units: 1.0

16-18 hours lecture

(Prerequisite: ENGL 101 or ENGL 101H with a grade of 'C' or better. Pass/No Pass)

This is an interactive course that analyzes the techniques of tutoring writing. Students will examine the role of writing tutors in one-on-one conferences, discuss tutoring theory, and observe tutors in the Writing Center and/or composition instructors in the classroom. Though this class is meant to prepare students to tutor writing, any student wishing to improve his/her writing skills will benefit from this course.

ENGL 101.0 ENGLISH COMPOSITION AND READING

Units: 4.0

CSU,UC

64-72 hours lecture

(Prerequisite: Completion of ENGL 50 with a grade of 'C' or better or eligibility as determined by VVC assessment.)

Principles and methods of research and expository writing. Analytical reading of source materials and writing of expository essays.

ENGL 101H HONORS ENGLISH COMPOSITION AND READING

Units: 4.0

CSU,UC

64-72 hours lecture

(Prerequisite: ENGL 50 minimum grade C.)

Principles and methods of expository writing. Analytical reading of source materials and writing of expository essays. Honors seminar will require more advanced resources and more complex assignments than ENGL 101.0.

ENGL 102.0 COMPOSITION AND LITERATURE

Units: 3.0 **CSU,UC** | 48-54 hours lecture

(Prerequisite: Completion of ENGL 101.0 or ENGL 101H with a grade of 'C' or better.)

An introduction to the genres of literature including short story, poetry, drama, and novel. Further training in writing, especially about literature.

ENGL 102H HONORS COMPOSITION AND LITERATURE

Units: 3.0 **CSU,UC** | 48-54 hours lecture

(Prerequisite: ENGL 101.0 or ENGL 101H minimum grade C.)

Further training in writing and introduction to the short story, novel, poetry, and drama. This course takes the methods of English 102 and promotes more comprehensive analysis, research, discussion and writing assignments. (UC credit limitation)

ENGL 104 CRITICAL THINKING AND COMPOSITION

Units: 3.0 **CSU,UC** | 48-54 hours lecture

(Prerequisite: ENGL 101.0 or ENGL 101H with a grade of 'C' or better.)

This course is designed to develop the student's critical thinking, reading and writing skills beyond the level achieved in ENGL 101.0 or ENGL 101H. It will focus primarily on the analysis and evaluation of expository and argumentative discourse, and on writing analytical and argumentative essays.

ENGL 104H HONORS CRITICAL THINKING AND COMPOSITION

Units: 3.0 **CSU,UC** | 48-54 hours lecture

(Prerequisite: ENGL 101.0 or ENGL 101H minimum grade C.)

This course is designed to develop the students' critical thinking, reading and writing skills beyond the level achieved in ENGL 101.0 or ENGL 101H. It will focus primarily on the analysis and evaluation of expository and argumentative essays. Honors seminar will deepen students' insights.

ENGL 109 CREATIVE WRITING

Units: 3.0 **CSU** | 48-54 hours lecture

(No prerequisite. Recommendation preparation: ENGL 101.0 or ENGL 101H. Grade Option)

Principles of creative expression. Topics may cover fiction, poetry, creative nonfiction, and/or drama.

ENGL 112 TECHNICAL WRITING

Units: 3.0 **CSU** | 48-54 hours lecture

(Prerequisite: ENGL 101 or ENGL 101H minimum grade C.)

Principles of effective writing in a variety of formats to suit specific technical audiences. Clarity and accuracy in written communication situations are stressed. Topics include formal and informal reports, special business letters, instructions, and proposals. Designed to simulate the technical writer's job.

ENGL 116 AUTHORS OF THE THEATRE

Units: 3.0 **CSU,UC** | 48-54 hours lecture

(No prerequisite. Recommended preparation: ENGL 101.0 or ENGL 101H)

A survey of playwrights from the Greeks to the present. The selected plays are read, discussed, and analyzed. It is both AA and BA applicable. See cross listing for TA 116.

ENGL 128 SPECIAL TOPICS

See Special Topics listing. Units: Variable units **CSU**

English Courses

ENGL 129 INDEPENDENT STUDY

See *Independent Study*. Units: 1-3 CSU

ENGL 138 COOPERATIVE EDUCATION

See *Cooperative Education listing*. Units: 1-8 CSU

ENGL 210A FICTION WRITING I

Units: 3.0 CSU | 48-54 hours lecture

(No prerequisite)

Beginning principles of writing fiction, focusing on the short story and the novel.

ENGL 210B FICTION WRITING II

Units: 3.0 CSU | 48-54 hours lecture

(No prerequisite. Grade Option.)

This workshop-style course addresses intermediate principles of writing fiction, focusing on the short story and the novel.

ENGL 211A POETRY WRITING I

Units: 3.0 CSU | 48-54 hours lecture

(No prerequisite. Grade Option.)

A beginning workshop-style course which includes a review of poetic forms, techniques, and revision strategies.

ENGL 211B POETRY WRITING II

Units: 3.0 CSU | 48-54 hours lecture

(No prerequisite. Grade Option.)

This workshop-style course addresses intermediate principles of writing poetry, focusing on poetic forms, techniques, and revision strategies.

ENGL 220 MODERN FICTION

Units: 3.0 CSU,UC | 48-54 hours lecture

(Prerequisite: ENGL 101.0 or ENGL 101H with a minimum grade of 'C'.)

Twentieth century literature, both English language and translated sources, emphasizing novels and short stories.

ENGL 225 POETRY

Units: 3.0 CSU,UC | 48-54 hours lecture

(Prerequisite: ENGL 101.0 or ENGL 101H minimum grade C.)

Study of poetry with consideration of versification, structure, imagery, diction, themes, and genres.

ENGL 230 SURVEY OF AMERICAN LITERATURE 1600-1865

Units: 3.0 CSU,UC | 48-54 hours lecture

(Prerequisite: ENGL 101.0 or ENGL 101H minimum grade C.)

A survey of exemplary items in the origin and development of American thought and culture from 1600 to 1865. Designed to provide an understanding and appreciation of American literary achievements through study of the works of writers including Bradford and Bradstreet, Edwards and Wheatley, Franklin, Irving, Poe, Stowe and Emerson. Also includes a study of Native-American folk tales and slave narratives.

ENGL 231 SURVEY OF AMERICAN LITERATURE 1865 TO PRESENT

Units: 3.0 CSU,UC | 48-54 hours lecture

(Prerequisite: ENGL 101.0 or ENGL 101H minimum grade C.)

A survey of exemplary items in the origin and development of American thought to the present. Designed to provide an understanding and appreciation of American literary achievements through study of the works of great writers including Whitman, Dickinson, Twain, Frost, Welty, Thurber, Tan and others.

ENGL 232 CHICANO/A AND LATINO/A LITERATURE

Units: 3.0 **CSU,UC** | 48-54 hours lecture

(Prerequisite: ENGL 101.0 or ENGL 101H minimum grade C.)

Introduction to the Mexican/American/Latino/a cultural experience through literary analysis of fiction, poetry, drama, and the essay. Studies literature in the context of literary/historical-political growth of Mexican/American/Latino/a identity and of current theories of analyzing multicultural writings.

ENGL 233 AFRICAN-AMERICAN LITERATURE

Units: 3.0 **CSU,UC** | 48-54 hours lecture

(Prerequisite: ENGL 101.0 or ENGL 101H minimum grade C.)

An introductory survey course of African-American oral and written literary traditions with consideration of historical and cultural roots.

ENGL 234 NATIVE AMERICAN LITERATURE (Formerly ENGL 162)

Units: 3.0 **CSU,UC** | 48-54 hours lecture

(Prerequisite: ENGL 101.0 or ENGL 101H minimum grade C.)

An introduction to Native American literature from the oral tradition to contemporary writing. Study of myths and legends, traditional oral narratives and songs, transitional forms such as oration and autobiography, and written genres (poem, short story, novel).

ENGL 235 CHILDREN'S LITERATURE

Units: 3.0 **CSU** | 48-54 hours lecture

(Prerequisite: ENGL 101.0 or ENGL 101H minimum grade C.)

A survey of children's literature, emphasizing folktales, narrative fiction, poetry and some non-fiction works. Also includes the history and development of literature and illustration for children, the selection of materials for various age groups, and literature and the media.

ENGL 236 YOUNG ADULT LITERATURE

Units: 3.0 **CSU** | 48-54 hours lecture

(Prerequisite: ENGL 101.0 or ENGL 101H minimum grade C.)

A survey of young adult literature, including classics, realistic fiction, fantasy, genre fiction, graphic novels, poetry, film, and current trends and issues pertaining to young adult literature.

ENGL 240 WORLD LITERATURE ANCIENT-EARLY RENAISSANCE

Units: 3.0 **CSU,UC** | 48-54 hours lecture

(Prerequisite: ENGL 101.0 or ENGL 101H minimum grade C.)

Masterpieces of world literature and their cultural contexts from ancient times through the early Renaissance.

ENGL 241 WORLD LITERATURE RENAISSANCE-MODERN

Units: 3.0 **CSU,UC** | 48-54 hours lecture

(Prerequisite: ENGL 101.0 or ENGL 101H minimum grade C.)

Masterpieces of world literature and their cultural contexts from late Renaissance until the present.

ENGL 245 SURVEY OF BRITISH LITERATURE EARLY MEDIEVAL-NEOCLASSICS

Units: 3.0 **CSU,UC** | 48-54 hours lecture

(Prerequisite: ENGL 101.0 or ENGL 101H minimum grade C.)

A survey of major British writers from the Middle Ages through the Eighteenth Century, including an examination of language development, historic and cultural backgrounds, and literary trends; special consideration of major authors such as Chaucer, Spenser, Marlowe, Shakespeare, Bacon, Donne, Milton, Dryden, and Pope.

English Courses

ENGL 246 SURVEY OF BRITISH LITERATURE ROMANTICS- 20th CENTURY

Units: 3.0 *CSU,UC* 48-54 hours lecture

(Prerequisite: ENGL 101.0 or ENGL 101H minimum grade C.)

A survey of major British writers from the Romantics and their contemporaries through the 20th century, including an examination of historic and cultural and literary trends. Special consideration of major authors such as Blake, Wordsworth, Byron, Browning, Wilde, Conrad, Yeats, Eliot, Woolf, Auden.

ENGL 247 SHAKESPEARE

Units: 3.0 *CSU,UC* 48-54 hours lecture

(Prerequisite: ENGL 101.0 or ENGL 101H minimum grade C.)

An introduction to Shakespeare's work through a study of his principal plays and the sonnets.

English As A Second Language

The Credit and Non Credit program of ESL is for Non-Native Speakers of English who wish to improve their English skills. The program is designed for students who want to pursue a career or a college degree or seek job advancement but lack the English skills to be successful. Areas of interest may include

- Vocational education
- Certificate program
- Associate's degree
- Transfer to a four year university

It is an intensive English language program for beginners of English and for those in the higher levels of English as a Second Language. The topics also include citizenship classes, computer and workplace literacy classes. These courses are offered for credit and non-credit.

There are 6 levels in the English as a Second Language Program. Each level is comprised of two or three core classes of Reading and Vocabulary, Writing and Grammar. Students who successfully complete Level 6 are eligible to advance into ENGL 6 and Certificate Courses at VVC.

ESL Level 1 – Beginning (Non-Credit Only)

- AENG 10.1, AENG 10.2, AENG 10.1C, AENG1

ESL Level 2 - High Beginning (Non-Credit Only)

- AENG 10.3, AENG 10.4, AENG10.4A, AENG 2

ESL Level 2.5 Pre – Intermediate (Non-Credit and Credit)

- AENG 10.5, ESL 23, ESL 25, ESL 27A, ESL 27B

ESL Level 3 – Low Intermediate (Non-Credit and Credit)

- AENG 10.7, ESL33A, ESL35A, ESL30A, ESL 37A

ESL Level 4 – High Intermediate (Credit and Non-Credit)

- AENG 10.9 , ESL35B, ESL37B, ESL 33B, ESL34

ESL Level 5- Low Advanced (Credit Only)

- ESL43, ESL43B, ESL45, ESL45A, ESL47, ESL48

ESL Level 6- High Advanced:

- ESL49A, ESL49B (Credit Only)

New students must take an ESL Assessment test to determine appropriate course level placement. The TOEFL score is not required.

Career Opportunities

Although ESL is not recognized as a separate major, it is a necessary component for success in any field for the non-native student.

Faculty

Maria Ruiz | Monika Niehus

INGLÉS COMO SEGUNDO IDIOMA (ESL)

ESL es el estudio de Inglés Como Segundo Idioma. El programa está diseñado para las personas en que el primer idioma no es inglés. California es un estado que es muy diverso en cultura e idiomas, donde la necesidad de aprender inglés es importantísimo para sobrevivir en la vida cotidiana estadounidense. Además el estudiante de ESL tiene que desarrollar destrezas en inglés para tener éxito en el colegio y la universidad. El programa de ESL tiene el fin asistirlas en alcanzar sus metas personales y educativas.

ENGLISH AS A SECOND LANGUAGE (ESL) COURSES

VVC offers a wide variety of noncredit ESL classes at lower levels, from low beginning to advanced level. Please consult the Class Schedule for a description of these classes, along with times and locations

English As A Second Language Courses

ESL 12A BASIC COMPUTER LITERACY

Units: 3.0

48-54 hours lecture

(No prerequisite. Recommended Preparation: Completion of AENG 10.1 or above or qualifying test score. Pass/No Pass) This course does not apply to the Associate Degree.

This is a three part course in ESL Computer Literacy for non-native speakers of English. The focus of the course is to develop language skills related to computer usage. Students will learn computer uses for ESL courses and educational purposes.

ESL 12B BASIC COMPUTER LITERACY

Units: 3.0

48-54 hours lecture

(No prerequisite. Recommended preparation: Completion of AENG 10.1, AENG 10.2, AENG 10.3, AENG 10.4 highly recommended. ESL 12A is strongly recommended. Pass/No Pass) This course does not apply to the Associate Degree.

This course is designed for non-native speakers of English. The focus of the course is to expand and develop basic computer knowledge using the most current Microsoft OS for ESL educational purposes.

ESL 23 PRE-INTERMEDIATE READING AND VOCABULARY

Units: 3.0

48-54 hours lecture

(No prerequisite. Pass/No Pass) This course does not apply to the Associate Degree.

This course is designed for non-native speakers of English. Focus is on development and practice of fundamental reading and vocabulary skills needed to academic and workplace settings. Reading skills include comprehension, understanding new vocabulary in context and scanning for specific information. Students read simplified texts on academic and vocational subjects.

ESL 25 PRE-INTERMEDIATE LISTENING AND SPEAKING

Units: 3.0

48-54 hours lecture

(No prerequisite. Pass/No Pass.) This course does not apply to the Associate Degree.

Course is designed for non-native speakers of English. This course focuses on fundamental speaking and listening skills for ESL students who have a basic knowledge of common English words and phrases. Students learn to understand short spoken passages, including questions and warnings. Speaking skills include describing familiar situations and events, such as giving basic information on the telephone.

ESL 27A PRE-INTERMEDIATE WRITING AND GRAMMAR

Units: 3.0

48-54 hours lecture

(No prerequisite. Pass/No Pass) This course does not apply to the Associate Degree.

This course is designed for non-native speakers of English. Course focus is on fundamental writing and grammar skills for ESL students who have a basic knowledge of common English words, phrases, and structure. Students write at the sentence and paragraph level, learn to organize ideas, and edit for grammar, spelling and punctuation.

ESL 27B PRE-INTERMEDIATE WRITING AND GRAMMAR II

Units: 3.0

48-54 hours lecture

(No prerequisite. Recommended preparation: ESL 12A, ESL 23A, ESL 27A or basic knowledge of keyboarding and grammar. Pass/No Pass) This course does not apply to the Associate Degree.

This class is the second of a two-part series of pre-intermediate grammar and writing classes. This course is designed for non-native speakers of English who want to develop grammar and writing skills. The focus is on reviewing verb tenses and introducing modals, adjectives, count and non-count articles, adverbs and adjectives. Students will practice writing and editing simple paragraphs.

English As A Second Language Courses

ESL 30A INTERMEDIATE PRONUNCIATION I

Units: 3.0 | 48-54 hours lecture

(No prerequisite. Recommended preparation: Completion of ESL 12A is strongly recommended. Pass/No Pass) This course does not apply to the Associate Degree.

This course is designed for non-native speakers of English who require further practice and instruction in pronunciation. Class will help improve communication skills and achieving clear speech for success in everyday situations, workplace and school settings. This class will focus on introducing sounds of vowels and consonants and their combinations. It will introduce the basic features of English stress, rhythm and intonation.

ESL 30B INTERMEDIATE PRONUNCIATION II

Units: 3.0 | 48-54 hours lecture

(No prerequisite. Recommended Preparation: ESL 30A, ESL 35A, qualifying test scores or equivalent. Pass/No Pass) This course does not apply to the Associate Degree

This course is designed for non-native speakers of English at the high intermediate and/or advanced level of ESL. Designed for students whose speech is continuing to cause communication difficulties at work, school, or in social situations. Students practice listening, rhythm, intonation and pronunciation.

ESL 33 READING AND VOCABULARY

Units: 3.0 | 32-36 hours lecture and 48-54 hours laboratory

(No prerequisite. It is recommendation that students should already have basic skills in decoding information and understanding at a literal level. They should be able to read and understand short, authentic texts such as letters and instructions. Pass/No Pass) This course does not apply to the Associate Degree.

A reading course for low intermediate ESL students emphasizing main ideas, outlining, and vocabulary in context.

ESL 33A LOW INTERMEDIATE READING AND VOCABULARY

Units: 3.0 | 48-54 hours lecture

(No prerequisite. Recommended Preparation: Students should already have basic skills in decoding information and understanding at a literal level. They should be able to read and understand short, authentic texts such as letters and instructions. Pass/No Pass) This course does not apply to the Associate Degree.

Designed for Low Intermediate ESL students who wish to improve reading skills. Course emphasizes reading skills, such as main ideas, comprehension, outlining, and developing vocabulary skills. Students will read short authentic texts and abridged readers and respond to reading passages. Students should understand at a literal level.

ESL 33B HIGH INTERMEDIATE READING

Units: 4.0 | 64-72 hours lecture

(No prerequisite. Recommended preparation: ESL 33. Pass/No Pass) This course does not apply to the Associate Degree.

This course is designed for non-native speakers of English who have intermediate proficiency in reading and writing English. Students will learn a variety of reading and vocabulary developmental strategies for college success. Students will learn to access a variety of technology based reading resources to further develop their reading skills.

ESL 34 HIGH INTERMEDIATE ENGLISH SKILLS AT THE WORKPLACE

Units: 3.0 | 48-54 hours lecture

(No prerequisite. Pass/No Pass) This course does not apply to the Associate Degree.

This course is designed for non-native speakers of English who wish to strengthen business communication skills. Course focus is on cultural differences, social etiquette, business idioms, and some business writing. Emphasis on developing fluency and comprehension.

ESL 35A LOW INTERMEDIATE LISTENING AND SPEAKING

Units: 3.0 | 48-54 hours lecture

(No prerequisite. Pass/No Pass) This course does not apply to the Associate Degree.

This course is designed for non-native speakers of English. Course focus is on casual and formal dialogues in commonplace situations, everyday language functions and conversation skills. Students learn common courtesies expressions, clarification strategies, idiomatic expressions and grammatical patterns in English.

English As A Second Language Courses

ESL 35B HIGH INTERMEDIATE LISTENING AND SPEAKING

Units: 3.0

48-54 hours lecture

(No Prerequisite. Recommended preparation: ESL 35A or appropriate score on ESL assessment. Pass/No Pass) This course does not apply to the Associate Degree.

This course is designed for non-native speakers of English who wish to continue developing listening and speaking skills in English. Students practice a variety of listening and speaking activities designed to develop critical thinking skills. Students engage in activities such as role play, simulation exercises, and conversational activities. Students learn how to express opinions and reach agreements.

ESL 37 INTERMEDIATE GRAMMAR

Units: 3.0

48-54 hours lecture

(No prerequisite. Recommended preparation: Minimum score of 31 on the ESL assessment or satisfactory completion of ESL 23, ESL 25 and ESL 27A and ESL 27B. Grade Option) This course does not apply to the Associate Degree.

Students at this level learn and apply rules of English grammar and structure for use in oral and written communication. This course provides practice in areas such as common verb tenses, question forms, and expressions of ability, permission and advice.

ESL 37A LOW INTERMEDIATE WRITING AND GRAMMAR

Units: 3.0

32-36 hours lecture and 48-54 hours laboratory

(No prerequisite. Recommended preparation: ESL 27B or appropriate ESL assessment test score or instructor recommendation. Pass/No Pass) This course does not apply to the Associate Degree.

This course helps students at low intermediate level develop writing and grammar skills appropriate for educational and personal success. Students write short compositions on familiar topics. They learn to apply principles of grammar as they write.

ESL 37B HIGH INTERMEDIATE WRITING AND GRAMMAR

Units: 3.0

48-54 hours lecture

(No prerequisite. Recommended preparation: ESL 37A or appropriate ESL assessment test score or instructor. Pass/No Pass) This course does not apply to the Associate Degree.

This course helps students at high intermediate level develop writing and grammar skills appropriate for educational and personal success. Students write short compositions on a variety of topics. They learn to apply principles of grammar as they write.

ESL 43 LOW ADVANCED READING AND VOCABULARY

Units: 3.0

48-54 hours lecture

(No prerequisite. Pass/No Pass) This course does not apply to the Associate Degree.

This is the first of two courses designed for non-native speakers of English who are approaching advanced level of proficiency in reading English. Emphasis is on further developing reading and vocabulary skills. Students are introduced to a variety of reading genres, word structure, vocabulary, and reading strategies.

ESL 43B HIGH ADVANCED READING AND VOCABULARY

Units: 4.0

64-72 hours lecture

(No prerequisite. Grade Option) This course does not apply to the Associate Degree.

This course is designed for non-native speakers of English. Skills include developing essays from longer reading passages. Students will respond to reading passages, reinforce vocabulary building and comprehension.

ESL 45 PUBLIC SPEAKING FOR ESL

Units: 3.0

48-54 hours lecture

(No prerequisite. Grade Option) This course does not apply to the Associate Degree.

This class is for non-native speakers of English at the advanced level of listening and speaking who wish to develop practical public speaking skills. The class is designed to help build confidence in speaking. Students will learn to use visual and audio aids to enhance presentation skills and to listen critically and objectively. Students will recite, develop, present, and evaluate speeches for a variety of situations.

English As A Second Language Courses

ESL 45A CROSS CULTURAL COMMUNICATION SKILLS

Units: 3.0

48-54 hours lecture

(No prerequisite. Grade Option) This course does not apply to the Associate Degree.

This course is designed for non-native speakers of English who wish to understand cultural differences of North American society. Course focus is on broadening intercultural understanding for students living and working in the USA. Topics focus on different aspects of mainstream North American cultures encountered in a work or social setting.

ESL 47 ADVANCED GRAMMAR

Units: 3.0

48-54 hours lecture

(No prerequisite. Grade Option) This course does not apply to the Associate Degree.

Students at advanced level learn and apply rules of English grammar and structure for use in oral and written communication. This course provides review practice and expanded study of verb tenses, gerunds and infinitives, and phrasal verbs, and introduces adjective clauses.

ESL 47A LOW ADVANCED GRAMMAR & WRITING I

Units: 3.0

48-54 hours lecture

(No prerequisite. Grade Option) This course does not apply to the Associate Degree.

This course is designed for non-native English students who are at the advanced level. ESL students will learn and apply rules of English grammar and structure for use primarily in written communication. This course provides review practice and expanded study of verb tenses, gerunds and infinitives, modals, and phrasal verbs. Students will learn to write academic paragraphs applying transitional signal and use formal vocabulary. Students will identify and compose a variety of paragraphs such as introductory, body, concluding paragraphs.

ESL 47B LOW ADVANCED GRAMMAR AND WRITING II

Units: 3.0

48-54 hours lecture

(No prerequisite. Grade Option) This course does not apply to the Associate Degree.

This course is the second of a two parts series of low advanced grammar and writing courses. The focus of the course is to continue to develop paragraphs writing with topic sentences, supporting detail and concluding paragraphs. Students will utilize core academic vocabulary. Students will write a variety of sentence structures using higher level grammatical structures.

ESL 49A BRIDGE TO COLLEGE SUCCESS: LISTENING AND SPEAKING AND PRONUNCIATION

Units: 4.0

64-72 hours lecture

(No prerequisite. Recommended Preparation: ESL 45 or successful completion of any high intermediate or advanced level ESL course, or qualifying placement score. Grade Option) This course does not apply to the Associate Degree.

This bridge course is designed to prepare ESL students to successfully participate in communicative situations in a college setting. Students will practice real world academic language by developing effective listening and speaking skills for success in college courses.

ESL 49B BRIDGE TO COLLEGE SUCCESS: GRAMMAR, READING AND WRITING

Units: 4.0

64-72 hours lecture

(No prerequisite. Recommended Preparation: Completion of any level four high intermediate ESL course equivalent or qualifying placement score. Grade Option) This course does not apply to the Associate Degree.

This bridge to college courses for non-native English speakers who have successfully passed level four or higher intermediate ESL. It is designed for students who plan to continue credit academic courses. The course will focus on written communication, college-level reading strategies and critical thinking skills at the advanced level of ESL.

English As A Second Language Courses

LEARN ENGLISH

Improve your ability to speak, read and write English

Victor Valley College offers two programs

CREDIT	NON-CREDIT
LOCATION: VVC Main Campus 18422 Bear Valley Road, Victorville, CA 92395	LOCATION: Hesperia High School 9898 Maple Ave, Hesperia, CA 92345 and VVC Main Campus
ELIGIBILITY: <ul style="list-style-type: none"> Classes are open to all: California residents pay \$46.00/unit 	ELIGIBILITY: <ul style="list-style-type: none"> Classes open to all (free classes)
CLASSES: <ul style="list-style-type: none"> ESL levels 1-6; individual classes offered in reading, writing, grammar, listening and speaking Tests, homework and grades are part of each class. Computer Skills 	CLASSES: <ul style="list-style-type: none"> ESL level 1-5 listening and speaking, reading and writing ESL/Citizenship Computer skills
FOCUS: <ul style="list-style-type: none"> Classes best prepare student for degree programs, vocational certificates, skills competency awards. Enroll for a 16 week, 4hrs/wk per semester in one or more classes. 	FOCUS: <ul style="list-style-type: none"> Communicative, life-skill emphasis Preparation for work and transfer to college Most classes offered 2 days/wk for 6 hrs/wk or Saturdays for 6 hrs (at VVC Main Campus)
ATTENDANCE: <ul style="list-style-type: none"> Students must follow instructor's guidelines- usually not more than 3 absences 	ATTENDANCE: <ul style="list-style-type: none"> Regular attendance is encouraged to make progress.
SUPPORT SERVICE: <ul style="list-style-type: none"> EOPS, Disabled Student Program and Services, tutoring, writing lab, computer lab access and bilingual counselors. 	SUPPORT SERVICE: <ul style="list-style-type: none"> Student services, computer lab access, Disabled Student Program and Service, Bilingual Academic and career counselors and tutoring.
Costs: <ul style="list-style-type: none"> All California residents pay \$46/unit for enrollment plus bus pass fees. Financial Aid and fee waivers available. Students pay for class textbooks, about \$60/per class. 	Costs: <ul style="list-style-type: none"> Classes are free Textbooks are provided to students during class.
EXTRAS: <ul style="list-style-type: none"> VVTA-Bus pass included Student ID with photo Childcare available(12/unit student and low income) 	EXTRAS: <ul style="list-style-type: none"> Student ID with photo VVTA- Bus pass (not mandatory)
ENROLLMENT: <ol style="list-style-type: none"> Complete application (Eng/Spanish) available on campus or online with assistance available in ESL or Admission offices on campus Take assessment test Attend ESL orientation Complete Financial Aid (FAFSA application & BOG) form if applicable Register for classes in Admission Office in Student Service (bldg. 52) or online through WEBADVISOR 	ENROLLMENT: <ol style="list-style-type: none"> Complete application (Eng/Spanish) available on campus or online with assistance available in ESL or Admission offices on campus Take Assessment test Attend ESL orientation Register for classes
ESL OFFICE MAIN CAMPUS Bldg. 21 Rm. 132 AND/OR 126 760-245-4271 ext. 2126 Bilingual Counselors: 760 245-4271 x2713 or ext. 2388	ESL OFFICE HESPERIA HIGH SCHOOL Rm. W25-W24 760-245-4271 ext. 2126 Bilingual Counselors: 760 245-4271 x2713 or ext. 2388

English As A Second Language Courses

Aprenda inglés

Mejore sus habilidades de hablar, leer y escribir inglés

El colegio de Victor Valley ofrece dos programas

CRÉDITO	NO CRÉDITO
LUGAR : campus principal del colegio 18422 Bear Valley Road, Victorville, CA 92395	LUGAR: Escuela secuandaria de Hesperia (HHS) 9898 Maple Ave, Hesperia, CA 92345 y campus principal del colegio
ELIGIBILIDAD: <ul style="list-style-type: none"> Clases están disponibles para todos: residentes del estado de California pagan \$46 por unidad. 	ELIGIBILIDAD: <ul style="list-style-type: none"> Clases están disponibles para todos (clases gratis)
CLASES: <ul style="list-style-type: none"> Niveles de inglés del 1 al 6; se ofrecen clases individuales en lectura, escritura, gramática, conversación. Exámenes, tareas, y calificaciones son parte de la clase. Clases de Computación 	CLASES: <ul style="list-style-type: none"> Niveles de inglés del 1 al 5; se ofrecen clases individuales en lectura y escritura, escuchar y hablar. Clases de ciudadanía estadounidense Clases de Computación
ENFOQUE: <ul style="list-style-type: none"> Estas clases preparan al estudiante para cursar en dirección a obtener un diploma del colegio y para certificados vocacionales (carreras cortas). La mayoría de las clases son de 16 semanas, 4 horas por semana. 	ENFOQUE: <ul style="list-style-type: none"> Comunicación, con énfasis en la vida diaria. Preparación para el trabajo y transferirse al colegio La mayoría de las clases son de 2 días por semana por 6 horas semanales o sábados por 6 horas(serán en el campus)
ASISTENCIA: <ul style="list-style-type: none"> Los estudiantes deben seguir las reglas del profesor; usualmente no se permiten más de 3 ausencias. 	ASISTENCIA: <ul style="list-style-type: none"> Se alienta al estudiante a que atienda regularmente para su progreso.
SERVICIO ESTUDIANTIL: <ul style="list-style-type: none"> EOPS, Programa para estudiantes con discapacidad, tutoría , laboratorio de escritura, acceso a computadoras y consejeros bilingües 	SERVICIO ESTUDIANTIL: <ul style="list-style-type: none"> EOPS, Programa para estudiantes con discapacidad, tutoría, laboratorio de escritura, acceso a computadoras y consejeros bilingües para carreras cortas.
Costos: <ul style="list-style-type: none"> Todos los <u>residentes de California</u> pagan \$46 por unidad para inscribirse, además de el pase del autobús Formularios para ayuda financiera para que sea exento de tarifas y matriculas. Los estudiantes deben pagar por sus libros, con un aproximado de \$60 por clase. 	Costos: <ul style="list-style-type: none"> Clases son gratis Los libros son prestados en clase.
EXTRAS: <ul style="list-style-type: none"> VVTA-pase de autobús Identificación con foto Guardería disponible (solo estudiantes de tiempo completo (12 unidades) con bajos ingresos) 	EXTRAS: <ul style="list-style-type: none"> Identificación con foto VVTA-pase de autobús (no es mandatorio)
INSCRIPCIONES: <ul style="list-style-type: none"> Llenar el formulario (Español) en el campus del colegio con asistencia disponible del departamento o en la oficina de admisión Tomar el exámen de evaluación Atender a la orientación de ESL Completar los formularios de ayuda financiera si es elegible. Registarse para las clases en las oficinas de admisión en el edificio 52 o puede hacerlo por internet mediante WEBADVISOR 	INSCRIPCIONES: <ul style="list-style-type: none"> Llenar el formulario (Español) en el campus del colegio con asistencia disponible del departamento o en la oficina de admisión Tomar el exámen de evaluación Atender a la orientación de ESL Registrarse en las clases que desea
OFICINAS DE ESL: Edificio 21 salones 132-126 o llamar al 760-245-4271 ext. 2126	OFICINA DE ESL EN HESPERIA: Salones W25 y W24 o llamar 760-245-4271 ext. 2126

Environmental Studies

A number of disciplines on campus offer classes and vocational certificates focusing on different aspects of Environmental Studies. See listings under the following departments: Agriculture and Natural Resources, Biology, Chemistry, Construction Technology, Computer Integrated Design and Graphics, Fire Technology, Geography, and Political Science.

Promoting an understanding of the interaction of human beings with their environment is the focus of Environmental Studies. Career opportunities cover a wide range of positions in public agencies, business, industry and nonprofit organizations which need individuals who can provide up-to-date environmental information and assist in compliance with environmental regulations. This transfer major combines courses from the biological sciences, physical sciences, and social sciences. The college now boasts a Green Technology Educational Pathway Initiative (GTPI) to help prepare students for success in this ever-evolving world. The GTPI is a collaborative among education, business, and the community that has spent several years developing programs promoting sustainability practices and training students in the skills needed to fill the emerging “green jobs.”

Transfer

For the most up-to-date information on these programs and others, visit www.assist.org. Please stop by the Transfer Center in Building 55 or make an appointment with a counselor if you have questions.

- **California State University, San Bernardino:** Environmental Studies major
- **University of California, Riverside:** Environmental Sciences major

Degrees and Certificates Awarded

Associate in Arts, Fine Arts

Associate Degree

To earn an Associate in Arts degree with a major in Fine Arts (07595), complete a minimum of 18 units from any of the following courses in addition to all other VVC general education and graduation requirements:

ANTHROPOLOGY

ANTH 151

ART

ART 101, 102, 104, 105, 106, 107, 108, 109 112, 113, 114, 115, 120, 121, 122, 123, 124, 125, 126, 128, 129, 131, 132, 134, 135, 141, 142, 150, 151; CART 133

MUSIC

MUSC 100, 101, 102, 103, 104, 105, 110, 111, 116, 117, 118, 120A-J, 122, 123, 124, 125, 126, 128, 129, 130, 131, 132, 134A, 135, 136, 139, 140, 141, 143, 144 145, 147, 202, 203, 204, 205, 210, 211, 220A/B, 222, 223

KINESIOLOGY/DANCE

KIN 103; KIND 160ABC, 161ABC, 162ABC, 163ABC, 166ABC, 167ABC, 169ABC, 170ABC, 171ABC, 174ABCD, 175ABCD, 176ABCD, 180,182,183

PHOTOGRAPHY

PHOT 52, 53, 54, 100, 101, 103, 105, 106 129

THEATRE ARTS

ENGL 116*, TA 101, 102, 104, 106, 107, 109, 110, 111, 113, 115, 115.1, 115.2, 115.3, 115.4, 116*, 117, 120, 128, 129, 160ABC, 161ABC, 166ABC, 167ABC, 170ABC, 171ABC, 174, 175, 180, 182, 183

**ENGL 116 and TA 116 are the same class.*

Transfer

For the most up-to-date information on these programs and others, visit www.assist.org. Please stop by the Transfer Center in Building 55 or make an appointment with a counselor if you have questions.

Fire Technology

Fire protection is a highly specialized professional field requiring extensive knowledge and use of scientific principles. Successful application of the fundamental principles of fire protection, including suppression and extinguishment of fires, rescue, emergency medical services, prevention techniques and practices, preplanning for fire protection, and disaster control, requires technical knowledge and the ability to work within an organized system at the fire ground or other emergency scene. These actions require trained, professional people to accomplish the goals and objectives of today's public and/or private organizations in meeting their commitment to the public and employees they serve. Fire Technology provides the student the opportunity to prepare for a rewarding career in the public fire service or in private industry.

For the most current information about VVC's Fire Technology programs, application deadlines, costs, and other requirements, please visit http://www.vvc.edu/academic/fire_technology/.

Fire Technology

This program provides vocational and technical in-service training for interested students. Each student who completes a program of courses that meets the specified requirements is entitled to a certificate of completion in that field. Certificates are awarded as evidence that well defined levels of proficiency have been attained and they are recognized as such by employers.

In order to be awarded the certificate, the student must have completed the prescribed program with at least a 2.0 grade point average in the prescribed course work. The number of courses prescribed for each certificate varies according to the area of training.

Career Opportunities

Apparatus Operator, Disaster Preparedness, Fire Administrative Analyst, Fire Chief, Fire Division Chief, Fire Fighter I, Fire Officer I, Fire Prevention Specialist, Fire Protection Engineer, Industrial Fire Safety Specialist

Faculty

Heath Cohen

Degrees and Certificates Awarded

Associate in Science, Fire Technology
Fire Fighter Certificate

Fire Prevention Officer Certificate
Fire Company Officer Certificate

Associate Degree

To earn an Associate in Science degree with a major in Fire Technology (10809) complete 18 units from any of the degree applicable certificate requirements or from any Fire Technology courses (numbered 50 and above) and meet all Victor Valley College graduation requirements. FIRE 138 (Cooperative Education) may be used as elective credit, but may not be used to fulfill major requirements.

Business Administration is also a highly recommended bachelor's degree major for people in this field who are seeking advancement. See Business Administration for transfer requirements.

*Courses numbered below 50 do not apply to the Associate Degree.

Transfer

Not usually a transfer major. Some Fire Technology courses do transfer as electives or fulfill subject credit requirements, California State University, Los Angeles offers a B.S. degree in Fire Protection Administration and Technology which requires a minimum of 18 major units to be completed in Fire Technology at a community college. Cal Poly San Luis Obispo and Humboldt State University offer degrees in Forestry with concentrations in Fire Management. Visit www.assist.org for community college courses which will transfer as requirements toward these bachelor's degrees. Students planning to pursue this bachelor's degree should also complete the CSU General Education-Breadth Requirements before transfer if possible.

Program Learning Outcomes

A student receiving a degree or certificate in this field will be able to:

- Demonstrate knowledge and skills required to respond appropriately to fire and environmental emergency situations at the private, city, state and federal levels with emphasis in one or more of the following areas: wildland firefighting; hazardous materials response; structural fire suppression, prevention, and investigation, disaster response, first responder; emergency medical technician; or leadership responsibilities.
- Demonstrate the ability to analyze, appraise and evaluate fire and emergency incidents and identify components of emergency management and fire fighter safety including: Size-up, report on condition, Incident Command System; RECEO; 10 Standard Firefighting Orders; and 18 Situations that "Shout Watch Out".
- Identify and comprehend laws, regulations, codes and standards that influence fire department operations, and identify regulatory and advisory organizations that create and mandate them, especially in the areas of fire prevention, building codes and ordinances, and firefighter health and safety.
- Identify minimum qualifications and entry level skills for fire fighter hiring. The student will be able to describe the following elements: application process; written exam process; physical agility exam, oral interview, chief's interview; background investigation; and fire fighter probationary process.
- Identify and describe common types of building construction and conditions associated with structural collapse and firefighter safety.
- Analyze the causes of fire, determine extinguishing agents and methods, differentiate the stages of the fire and fire development, and compare methods of heat transfer.

Fire Fighter Academy

Required prerequisites for the Fire Academy:

Fire 11B*	Confined Space Rescue Awareness	0.5
Fire 66	Basic Incident Command	1.0
Fire 82A	Hazardous Materials First Responder Awareness	1.5
EMS 60	Emergency Medical Technician	9.5

*Courses numbered below 50 do not apply to the associate's degree.

Victor Valley College's Fire Technology Department is an accredited Regional Training Program (ARTP) as designated by the Office of the California State Fire Marshal (CSFM). As an ARTP, the VVC Fire Technology Department is authorized to deliver a CSFM Accredited Firefighter I Academy and a full suite of CSFM courses leading to advanced levels of certification. In addition, the VVC Fire Technology Department is authorized by CSFM to deliver Fire Fighter I certification examinations in support of CSFM's accreditation by the International Fire Service Accreditation Congress (IFSAC) and the National Board of Fire Service Professional Qualifications (Pro Board).

FIRE 95 – Basic Fire Academy is a 13 unit course. Students must submit applications by appropriate deadlines to enter the academy. In addition to this course there is recommended coursework that enables students to sit for certification exams and gain employment. The following courses should be taken during the same semester as FIRE 95.

FIRE 4B	First Responder Operational Weapons of Mass Destruction	0.5
FIRE 11	Low Angle Rope Rescue Operational	0.5
FIRE 11E	Rapid Intervention Crew Tactics	1.5
EMS 40A	Firefighter Physical Agility Entrance Exam Techniques	1.0
FIRE 53	Hazardous Materials First Responder Operational Decontamination	0.5
FIRE 63A	Auto Extrication	0.5

Fire Technology

FIRE FIGHTER CERTIFICATE OF ACHIEVEMENT (04969)

Awarded to the student who successfully completes the following course of study to meet the minimum qualifications and competencies as required by National Fire Protection Association and California State Fire Marshal's Fire Fighter I certification program.

Units Required: 32.0

All of the following must be completed with a grade of "C" or better:

FIRE 100	Principles of Emergency Services	3.0
FIRE 101	Fundamentals of Fire Service Operations	3.0
FIRE 102	Fire Prevention Technology	3.0
FIRE 103	Fire Protection and Systems	3.0
FIRE 104	Fire Behavior and Combustion	3.0
FIRE 82A	Hazardous Materials First Responder Operational	1.5
EMS 60	Emergency Medical Technician I	5.0
FIRE 95	Basic Fire Academy	12.5

FIRE PREVENTION OFFICER CERTIFICATE OF ACHIEVEMENT (07594)

Describes an individual who has successfully completed the competencies as required for a certified fire prevention officer by the California State Fire Marshal's Office. Meets entry requirements for fire prevention specialist and/or fire prevention officer.

Units Required: 30.0

All of the following must be completed with a grade of "C" or better:

FIRE 100	Principles of Emergency Services	3.0
FIRE 101	Fire Service Operations	3.0
FIRE 102	Fire Prevention Technology	3.0
FIRE 103	Fire Protection Equipment and Systems	3.0
FIRE 104	Fire Behavior and Combustion	3.0
FIRE 107	Fire Investigation or	3.0
FIRE 77	Investigation 1A	2.0
FIRE 70	Fire Instructor Training 1A	2.0
FIRE 71	Fire Instructor Training 1B	2.5
FIRE 74,75, & 78	Fire Prevention 1A, 1B, 1C	6.0
FIRE 76	Fire Management 1 - Supervision for Company Officers	2.5

Fire Technology Courses

FIRE 4B FIRST RESPONDER OPERATIONAL WEAPONS OF MASS DESTRUCTION

Units: 0.5

8-9 hours lecture

Prerequisite: FIRE 82A or CSTI Has-Mat First Responder Operational Certification. Pass/No Pass) This course does not apply to the Associate Degree.

This course introduces the student to the basic concepts for first responder operational procedures at the scene of a potential or actual terrorist incident and discusses safety and survival tactics.

FIRE 9A FIRE CONTROL IV, OIL AND GAS FIRE FIGHTING TECHNIQUES

Units: 0.5

8-9 hours lecture

(No prerequisite. Pass/No Pass) This course does not apply to the Associate Degree.

This course provides the fire fighter student with live fire situations to gain skills and experience in combating fires involving liquefied petroleum gas and flammable liquids. Subjects include flammable liquid fire behavior, safety on the fire ground, extinguishing agents, flammable liquid/gas transportation vehicles, water-flow requirements and actual fire extinguishing exercises. A basic knowledge of firefighting skills and knowledge plus access to appropriate safety equipment and clothing is presumed.

FIRE 10 FIRE FIGHTER SKILLS MAINTENANCE

Units: 4.0

16-18 hours lecture and 144-162 hours laboratory

(No prerequisite: Recommended preparation: Employment as a fire fighter with a recognized fire protection agency (State mandated). Employment as a career fire fighter or paid call fire fighter. Pass/No Pass.) This course does not apply to the Associate Degree.

A series of lectures and manipulative drills designed to provide maintenance of skills learned, including updates in technology relating to fire department organization, hoses, ladders, tools and equipment, salvage, fire chemistry, extinguishers and agents, fire control, prevention, arson, crowd and traffic control, mutual aid, communications, fire safety and emergency rescue techniques.

FIRE 10C COMPANY OFFICER'S SKILLS MAINTENANCE

Units: 1.5

16-18 hours lecture and 24-27 hours laboratory

(Prerequisites: Employment as a wildland fire fighter or fire fighter serving a community with wildland or interface fire conditions. State mandated. Pass/No Pass.) This course does not apply to the Associate Degree.

This course provides the fire fighter company officer student with new information and skill development to maintain efficiency and effectiveness as a company officer and fire fighter. New policies, procedures and equipment are presented and student demonstrates proficiency in using tools, tactics and strategies for managing personnel, budgets and legal responsibilities in today's fire service.

FIRE 10D HAND CREW FIRE FIGHTER SKILLS MAINTENANCE

Units: 3.5

24-27 hours lecture and 96-108 hours laboratory

(Prerequisites: Employment as a hand crew fire fighter with a modern fire service agency. State mandated. Pass/No Pass.) This course does not apply to the Associate Degree.

This course provides the fire fighter student with new information and skill development to maintain efficiency and effectiveness as a wild land hand crew fire fighter. New policies, procedures and equipment are presented and student demonstrates proficiency in using tools, tactics and strategies for constructing and maintaining a fire line and other related fire control tactics and operations. CDF certified.

FIRE 11 LOW ANGLE ROPE RESCUE OPERATIONAL

Units: 0.5

24-27 hours laboratory

(No prerequisite. Recommended preparation: FIRE 11B, FIRE 66 AND FIRE 95. Pass/No Pass) This course does not apply to the Associate Degree.

This course is designed to equip the student with the information, techniques and methods for utilizing rope, webbing, hardware friction devices, and litters in low angle rescue situations. Topics include rope and related equipment, anchor systems, safety lines, stretcher lashing and rigging, mechanical advantage, single line and two line rescue systems. This course is designed for the fire fighter student with essential firefighting skills.

Fire Technology Courses

FIRE 11A RESCUE SYSTEMS I

Units: 1.5

16-18 hours lecture and 24-27 hours laboratory

(Prerequisite: FIRE 11. Pass/No Pass) This course does not apply to the Associate Degree.

The 40-hour State Fire Rescue Systems I course is designed to provide the student with the ability to apply basic search and rescue skills, under the California Urban Search and Rescue Operational levels. Students learn to approach rescue situations safely and understand the organizational concerns at an All-Risk technical rescue incident. Upon completion of the course, the student will receive a California State Fire Marshals Certificate, which is the foundation requirement for other urban search and rescue classes.

FIRE 11B CONFINED SPACE RESCUE AWARENESS

Units: 0.5

8-9 hours lecture

(No prerequisite. Pass/No Pass) This course does not apply to the Associate Degree.

Designed for all fire service personnel. This course provides instruction in identifying a permit and non-permit required confined space, the hazards associated with confined spaces, target industries and hazards, state regulations, communications, and equipment requirements. This course does not qualify participants to make permit required entries. OSFM-SFT certification. Material and FSTEP Certification Fee.

FIRE 11D CONFINED SPACE RESCUE OPERATIONAL

Units: 1.5

16-18 hours lecture and 24-27 hours laboratory

(Prerequisite: FIRE 11 and FIRE 11B. Pass/No Pass) This course does not apply to the Associate Degree.

This course is designed for personnel who in the discharge of rescue duties find themselves working in “immediately dangerous to life and health environments”. This is the 40 hour California State Fire Marshal course required for USAR Team members.

FIRE 11E RAPID INTERVENTION CREW TACTICS

Units: 1.5

16-18 hours lecture and 24-27 hours laboratory

(Prerequisite: Fire Fighter I or equivalent experience, per Office of the State Fire Marshal. Pass/No Pass) This course does not apply to the Associate Degree.

This course is designed to meet OSHA respiratory protection standards for two in/two out and provides students with self survival and basic firefighter rescue skills.

FIRE 11G AUTO EXTRICATION TECHNIQUES

Units: 1.0

8-9 hours lecture and 24-27 hours laboratory

(Prerequisite: Fire Fighter I or equivalent experience, per Office of the State Fire Marshal. Pass/No Pass) This course does not apply to the Associate Degree.

This course is a certified California State Fire Marshal course that provides students with hands-on experience in the procedures and systems utilized during an automobile extrication. Subjects covered include: Auto extrication, types of hand and power tools, removing windows, opening doors, removing roofs, pulling steering wheels, moving foot pedals, raising dashboards, pulling seats, stabilization of vehicles, and simulated rescues of trapped victims.

FIRE 40 FIRE FIGHTER ENTRANCE EXAMINATION TECHNIQUES

Units: 0.5

8-9 hours lecture

(No prerequisite. Grade Option) This course does not apply to the Associate Degree.

This course is designed to prepare the student to take and successfully pass the entrance level fire fighter examination process. Topics discussed include: seeking employment opportunities, the application process, the various examinations given to applicants, oral interviews, and other aspects of the examination process.

Fire Technology Courses

FIRE 40A FIRE FIGHTER PHYSICAL AGILITY ENTRANCE EXAM TECHNIQUES

Units: 1.0 | **48-54 hours laboratory**

(Prerequisite/Co-requisite: FIRE 95. Pass/No Pass) This course does not apply to the Associate Degree.

This course is designed to prepare the student to take the entrance level firefighter physical agility examination through physical conditioning and specificity training. Students are shown varying entrance exam events often used in the physical agility portions and basic ergonomic techniques. General lecture on health and the importance of firefighter physical fitness. Emphasis on physical conditioning and exercise.

FIRE 51A FIREFIGHTER/EMT PUBLIC SAFETY VERTICAL INTEGRATION

Units: 4.5 | **8-9 hours lecture and 192-216 hours laboratory**

(Prerequisite: FIRE 95)

This course is the field externship portion of the FIREFIGHTER I Academy. Students will spend lab hours in the field with an all-risk fire department performing the duties of a Firefighter/EMT.

FIRE 51F FIRE CONTROL 3B

Units: 0.5 | **24.0-27.0 hours lecture laboratory**

(No prerequisite)

This course is designed to develop fundamental skills in combating structure fires by providing the students with a thorough understanding of fire behavior, ventilation procedures and techniques, interior fire attack, and exterior fire attack using a live-fire simulator. In many cases, this will be the fire fighter's first exposure to live structural fire fighting..

FIRE 51G FIRE CONTROL 4

Units: 0.5 | **24.0-27.0 hours lecture laboratory**

(No prerequisite)

This course provides the knowledge and skills that prepare a firefighter to extinguish an ignitable liquid fire, control a flammable gas fire, and develop an incident action plan for a pipeline emergency.

FIRE 53 HAZARDOUS MATERIALS FIRST RESPONDER OPERATIONAL DECONTAMINATION

Units: 0.5 | **8-9 hours lecture**

(Prerequisite: FIRE 82A. Pass/No Pass)

This course provides the student with the information and skills to safely and competently decontaminate people and equipment at a hazardous materials (haz mat) incident. California Specialized Training Institute (CSTI) certified. Meets federal and state requirements as listed in 29 CFR 1910.120 (q), CCR 5192 (q), NFPA472. \$10.00 fee for CSTI certificate.

FIRE 53A FIRE APPARATUS DRIVER/OPERATOR 1A: EMERGENCY VEHICLE OPERATIONS

Units: 1.5 | **16-18 hours lecture and 24-27 hours laboratory**

(No prerequisite.)

This course provides the student with information on driver responsibilities, recognized standards, and related laws for fire apparatus. Topics include basic inspections, documentation, maintenance, and troubleshooting fire apparatus, and techniques on driving and positioning fire apparatus. Each student also has the opportunity to increase his or her driving skills during simulated driving conditions. Designed for fire service emergency response personnel. (Former course number FIRE 63)

FIRE 54A TRUCK ACADEMY

Units: 2.0 | **96-108 hours laboratory**

(No prerequisite.)

This course is for veteran firefighters or other interested students that want to enhance their knowledge and ability as it pertains to the fire ground operations associated with truck company tactics and strategy. Basic roof construction, vertical and horizontal ventilation, forcible entry, positive and negative ventilation, search and rescue, thermal imaging technology, firefighter safety and survival, rapid intervention tactics, elevator rescue and related truck company operations will be discussed.

Fire Technology Courses

FIRE 55C INCIDENT MANAGEMENT OF THE FIREFIGHTER EMERGENCY

Units: 0.5

24-27 hours lecture

(No prerequisite. Pass/No Pass)

This command level awareness course provides the student with the incident management terminology and methodology that is employed during a fire fighter emergency. Classroom simulations based on case studies allow students to participate in simulated incident command positions during a fire fighter emergency.

FIRE 59 BASIC WILDLAND FIRE FIGHTER ACADEMY

Units: 3.5

48-54 hours lecture and 24-27 hours laboratory

(No prerequisite. Recommended preparation: FIRE 11B Must have/obtain Title 8-Confined Space Awareness certificate; FIRE 82A must have/obtain CSTI Haz-Mat First Responder Operational Certificate; must have/obtain CAL FIRE - EEO/Sexual Harassment Prevention certification; must have/obtain Title 22 - EMS -Public Safety First Aid, or Emergency Medical Responder, or Emergency Medical Technician Basic certification; must have/obtain Title 22 - EMS-CPR/AED Public Safety certification; must have/obtain CAL FIRE - Wildland Firefighter Safety \$ Survival Level 1 certification; must have/obtain FEMA-EMI Online - IS-100, ICS 100, an introduction to the incident command system certification; must have/obtain NWCG - S-190, Introduction to wildland fire behavior (classroom only) certification; must have/obtain FEMA-EMI Online - IS-700, NIMS National Response Plan certification; must have/obtain SFT - Firefighter Survival certification.)

This course presents information and skill development to students seeking employment and a career with a wildland fire agency. Several requisites/entrance skills required for CAL FIRE certification. This course provides 80 hours of the 179 hours of wildland firefighter training required for employment with the California Department of Forestry and Fire Protection (CALFIRE) and includes the basic requirements for the US Forest Service. Upon completion, students will receive National Wildland Coordinating Group (NWCG) certification in I-100, S-110, S-130, S-190, and L-180. Students must have a good attitude and a willingness to work hard.

FIRE 59B WILDLAND FIRE FIGHTER'S SKILLS MAINTENANCE

Units: 1.5

16-18 hours lecture and 24-27 hours laboratory

This course provides the fire fighter student with new information and skill development to maintain efficiency and effectiveness as a wildland fire fighter. New protocols, procedures and equipment are presented and student demonstrates proficiency in using tools, tactics and strategies for fire control. (Previously FIRE 10B)

FIRE 61G FIRE LINE EMERGENCY MEDICAL TECHNICIAN (EMT)

Units: 1.0

16-18 hours lecture

(No prerequisites.: Recommended Preparation: Current EMT-1 certification (state mandated per CFSTES policy), employment as a fire fighter in a public or private fire service organization. Pass/No Pass)

This eight hour course is designed to prepare the fire fighter, Emergency Medical Technician to safely operate at a major wildland fire incident at the fire line location. Course covers duties and responsibilities of the Fire Line EMT; equipment needs, helicopter safety, the Incident Command System (ICS) organization, review of treatments for common fire line injuries, and use of makeshift aids.

FIRE 61J RESCUE SYSTEMS 2

Units: 1.5

16-18 hours lecture and 24-27 hours laboratory

(No prerequisite: Pass/No Pass) This course does not apply to the Associate Degree.

This course is designed for personnel who in the discharge of rescue duties will engage in missions that encompass numerous hazards such as those involving confined spaces, energized electrical services, hazardous materials, adverse weather, unstable structures, high technology rescue tools, emergency building shoring, breaking, breaching, burning and cutting, and lifting and moving heavy objects.

FIRE 61K RESCUE SYSTEMS 3: STRUCTURE COLLAPSE TECHNICIAN

Units: 0.5

24-27 hours laboratory

(No prerequisite. Pass/No Pass)

Bridges the training gap between the California State Fire Training Rescue Systems 2 Advanced Rescue Skills course and the Federal Emergency Management Agency Structural Collapse Technician course. Key topics include: power actuated tools, pneumatic shores, additional tools and techniques for breaking and breaching, cutting a tensioned cable, the "O" course, rigging, and crane operations.

Fire Technology Courses

FIRE 61L ROPE RESCUE TECHNICIAN

Units: 1.0 | 48-54 hours lecture

(No prerequisite)

This course will prepare participants to undergo competency testing for high angle rescue. The scope of the program is to familiarize participants with the high angle environment and experience; and for them to safely participate in the engineering and operation of simple to complex rescue systems.

FIRE 63A AUTO EXTRICATION

Units: 0.5 | 24-27 hours laboratory

(No prerequisite. Pass/No Pass)

Provides hands-on experience in the procedures and systems utilized during an automobile extrication. Subjects covered include: Auto Extrication, types of hand and power tools, removing windows, opening doors, removing roofs, pulling steering wheels, moving foot pedals, raising dashboards, pulling seats, stabilization of vehicles, and simulated rescues of trapped victims.

FIRE 64 FIRE APARATUS DRIVER/OPERATOR IB: PUMP OPERATIONS

Units: 1.5 | 16-18 hours lecture and 24-27 hours laboratory

(No prerequisite. Recommended preparation: FIRE 95. Pass/No Pass)

The course provides the student with information on pump construction and theory of pump operations. Topics include: methods for performing basic hydraulics and techniques on basic inspections, documentation, maintenance, and troubleshooting fire pumps. Each student also has the opportunity to increase his or her pumping skills during simulated pumping conditions. Designed for fire service emergency response personnel.

FIRE 65 BASIC WILDLAND FIRE CONTROL

Units: 3.5 | 24-27 hours lecture, and 96-108 hours laboratory

Offered Spring. (No prerequisite)

Basic wildland engine and hand-crew training. The course covers fire suppression organizations, fire behavior, meteorology, suppression techniques, and safety. Meets federal fire agencies requirements for employees and mutual aid cooperators.

FIRE 66 BASIC INCIDENT COMMAND

Units: 1.0 | 16-18 hours lecture

(No prerequisite. Recommended preparation: Federal Emergency Management Institute's ICS-100. Pass/No Pass)

This course introduces students to the principles of the Incident Command System (ICS) associated with incident-related performance. Topics include: leadership and management, delegation of authority and management by objectives, functional areas and positions, briefings, organizational flexibility, transitions and transfers. CSFM FSTEP Certification.

FIRE 67 TRENCH RESCUE

Units: 0.5 | 24-27 hours laboratory

(Prerequisite: FIRE 95 with a grade of 'C' or better. Pass/No Pass)

This course is designed to provide hands on techniques for fire service personnel to effect a rescue at an excavation or trench cave-in. Topics include: critical considerations while responding to trenching emergencies; evaluation of cave-in scenes; basic life support procedures and temporary protection for victims; specialized tool usage; shoring techniques; and below grade rescue safety procedures.

FIRE 69 RESCUE PRACTICES

Units: 3.0 | 32-36 hours lecture and 48-54 hours laboratory

(No prerequisite. Pass/No Pass)

Rescue practices will provide training for emergency service personnel in reaching victims injured in collisions, cave-ins, collapse, or inaccessible areas such as mountainous terrain. Course includes training in both light and heavy auto extrication and packaging victims for transport; recovery of victims of earth collapse such as trench rescue; basic repelling techniques and use of the basket stretcher.

Fire Technology Courses

FIRE 70 INSTRUCTOR IA – INSTRUCTIONAL TECHNIQUES PART I

Units: 2.5

40-45 hours lecture

(No prerequisite)

This is the first of a three-course series. Topics include methods and techniques for training in accordance with the latest concepts in career education; selecting, adapting, organizing, and using instructional materials appropriate for teaching cognitive lessons; criteria and methods to evaluate teaching and learning efficiency; and an opportunity to apply major principles of learning through teaching demonstrations. Two (2) student instructor teaching demonstrations are required of all. Designed for personnel preparing for company officer, SFT registered instructor or training officer position.

FIRE 70C TRAINING INSTRUCTOR 1C: INSTRUCTIONAL DEVELOPMENT TECHNIQUES

Units: 2.5

40-45 hours lecture

(Prerequisite: FIRE 70 and FIRE 71 completed with a grade of "B" or better, or Training Instructor 1A and 1B certification taken from another school.)

This is the third of a three-course series. Topics include methods and techniques for developing lesson plans, ancillary components, and tests in accordance with the latest concepts in career education. The course offers the opportunity to develop, receive feedback, and finalize instructional materials and deliver a teaching demonstration. Two (2) student instructor teaching demonstrations are required of all.

FIRE 71 TRAINING INSTRUCTOR 1B – PSYCHOMOTOR LESSON DELIVERY

Units: 2.5

40-45 hours lecture

(Prerequisite: FIRE 70 with a grade of C or better.)

This is the second of a three-course series. Topics include methods and techniques for training in accordance with the latest concepts in career education; selecting, adapting, organizing, and using instructional materials appropriate for teaching psychomotor lessons; criteria and methods to evaluate teaching and learning efficiency; and an opportunity to apply major principles of learning through teaching demonstrations. Two student instructor teaching demonstrations are required of all. Designed for personnel preparing for a Company Officer, SFT Registered Instructor, or Training Officer position.

FIRE 72 COMMAND IA – STRUCTURE FIRE COMMAND OPERATIONS FOR COMPANY OFFICERS

Units: 2.0

32-36 hours lecture

(Prerequisite: FIRE 66 minimum grade B or valid ICS 200 certificate or equivalent. Pass/No Pass.)

This State Fire Marshal course offers an introduction to command principles, command safety and risk management principles. Company officer initial actions at an incident including the development of incident priorities, strategy, and tactics. Information on the roles and responsibilities of a Company Officer for post-incident actions and the opportunity to gain experience in a controlled environment through structure fire incident simulations.

FIRE 72C FIRE COMMAND 1C I-ZONE FIREFIGHTING FOR COMPANY OFFICERS

Units: 2.0

32-36 hours lecture

(No prerequisite)

This course is designed around the responsibilities of the Company Officer at a wildland/urban interface incident. It will bring the structural Company Officer out of the city and into the urban/interface incident. In other words, from his or her comfort zone into an area that could very well be quite unfamiliar. This course is required for Fire Officer Certification by the Office of the State Fire Marshal.

FIRE 73 FIRE COMMAND IB – INCIDENT MANAGEMENT FOR COMPANY OFFICERS (1998)

Units: 2.0

32-36 hours lecture

(Prerequisite: SFT Command 1A and ICS 200 certification.)

Designed for first-in incident commander and company officers. This course provides the student with information on tactics, strategies, and scene management for multi-casualty incidents, hazardous materials incidents, and wildland fires. Each student also has the opportunity to increase his or her knowledge and skills by handling initial operations at these types of incidents through simulation and class activities. This course applies to Fire Officer Certification.

Fire Technology Courses

FIRE 74 FIRE PREVENTION IA

Units: 2.0

32-36 hours lecture

(No prerequisite. Recommended preparation: FIRE 102.)

Designed for the entry-level fire inspector. Upon completion of this course, the student will have a basic knowledge of the certification and capstone task book process; the role of the fire inspector including; the inspection process; how to investigate, document, and resolve complaints; the legal process as it relates to the role of the fire inspector; permit types and processes; plan review; and public education including its purpose and how to evaluate needs and select a delivery model.

FIRE 74C FIRE PREVENTION 2A

Units: 2.5

40-45 hours lecture

(No prerequisite)

This course provides the most up-to-date information on laws and regulations pertaining to systems, description, installations and problems relating to fire protection systems. This course is specifically designed for in-service fire department personnel wishing to complete their Prevention Officer II certification.

FIRE 74D FIRE PREVENTION 2B

Units: 2.5

40-45 hours lecture

(Prerequisite: Completion of State Fire Training (SFT) Fire Prevention Officer Certification Track)

This course provides the participants with extensive, in depth information about the fire and life safety standards of buildings as they relate to Titles 19 and 24. Topics for discussion include: Types of construction, construction methods and materials, interior finishes, roof coverings, occupancy and more.

FIRE 74E FIRE PREVENTION 2C

Units: 2.5

40-45 hours lecture

(Prerequisite: Completion of State Fire Training (SFT) Fire Prevention Officer Certification Track)

This course introduces the participants to unique and unusual prevention challenges. Topics include: Industrial ovens, cleaning and finishing processes, welding, refrigeration systems, medical gases, fireworks, and special extinguishing systems.

FIRE 75 FIRE PREVENTION IB

Units: 2.0

32-36 hours lecture

(No prerequisite)

This course provides the most up-to-date information on laws and regulations pertaining to systems, description, installations and problems relating to fire protection systems. This course is specifically designed for in-service fire department personnel wishing to complete their SFT Prevention Officer I Certification.

FIRE 76 MANAGEMENT 1-SUPERVISION FOR COMPANY OFFICERS

Units: 2.5

40-45 hours lecture

(No prerequisite)

This course is designed to prepare or enhance the first line supervisor's ability to supervise subordinates. It introduces key management concepts and practices utilized in the California Fire Service. The course includes discussions about decision making, time management, leadership styles, personnel evaluations, and counseling guidelines. This course applies to Fire Officer certification.

FIRE 77 INVESTIGATION IA

Units: 2.5

40-45 hours lecture

(Recommended Preparation: FIRE 102)

This course provides the student with an introduction and basic overview of fire scene investigation. Provides information on fire scene indicators, and introduces fire service personnel to the concepts of fire investigation. Applies to Fire Officer and Fire Investigator I certification.

Fire Technology Courses

FIRE 78 FIRE PREVENTION IC

Units: 2.0

32-36 hours lecture

(No prerequisite)

This course provides the student with information on how to safely store, handle, dispense and transport flammable liquids and gases. Topics of discussion include: bulk handling and storage requirements, transportation of flammable and combustible liquids and gases, fire code requirements for storage outdoors, indoors, inside special rooms and portable container requirements. Applies towards Fire Prevention Officer I certification.

FIRE 82 HAZARDOUS MATERIALS FIRST RESPONDER AWARENESS

Units: 0.5

8-9 hours lecture

(No prerequisites)

This course is designed to provide the student with information essential to those people who are likely to be first responders at hazardous materials incidents. Designed to meet federal and state requirements for awareness training for employees handling and using hazardous materials.

FIRE 82A HAZARDOUS MATERIALS FIRST RESPONDER OPERATIONAL

Units: 1.5

24-27 hours lecture

(No prerequisite. Pass/No Pass)

This course provides the students with a fundamental knowledge of the factors affecting operating procedures at a Hazardous Material Incident. This course will improve the capabilities of the first responder to respond to a Haz Mat event in a safe and competent manner, within the typical resource and capability limits at the "operational" level. This course meets the First Responder Operational Haz Mat Emergency Response certified course requirements of California Code of Regulations (CCR) Title 19, Division 2, Chapter 1, Subchapter 2, Sections 2510-2560.

FIRE 86 INTERMEDIATE INCIDENT COMMAND SYSTEM (ICS)

Units: 1.5

24-27 hours lecture

(Prerequisite: FIRE 66 or experience as an Emergency Responder using the ICS system. Pass/No Pass)

This course provides training on resources for personnel who require advanced application of the Incident Command System (ICS). The target audience for this course is for individuals who may assume a supervisory role in expanding incidents or Type 3 incidents. These incidents may extend into multiple operational periods. This course expands upon information covered in the ICS-100 and ICS-200 courses. This course will include but not be limited to: unified command, incident/event assessment and objective development, the ICS planning process, incident/event resource management, transfer of command and demobilization.

FIRE 95 BASIC FIRE ACADEMY

Units: 13.0

120-135 hours lecture and 264-297 hours laboratory

(Prerequisite: FIRE 11B with a grade of "C" or better, or CA State Fire Marshall Confined Space Awareness Certificate; FIRE 82A with a grade of "C" or better, or CSTI HazMat FRO First Responder Operational Certificate; FIRE 66 with a grade of "C" or better, or I200 Cert.; and EMS 60 with a grade of "C" or better, or EMT certification.)

Basic Fire Academy provides basic training for individuals interested in becoming a career firefighter. Comprehensive introduction to basic firefighting theory and skills required in modern firefighting, including: study of characteristics and behavior of fire; practice in fundamental fire suppression activities with special attention on safety; practice in basic rescue techniques; study of public service principles and fire service etiquette. Students must attend a mandatory orientation.

FIRE 100 PRINCIPLES OF EMERGENCY SERVICES

Units: 3.0

CSU 48-54 hours lecture

(No prerequisite)

This course provides an overview to fire protection and emergency services; career opportunities in fire protection and related fields; culture and history of emergency services; fire loss analysis; organization and function of public and private fire protection services; fire departments as part of local government; laws and regulations affecting the fire service; fire service nomenclature; specific fire protection functions; basic fire chemistry and physics; introduction to fire protection systems; introduction to fire strategy and tactics; life safety initiatives.

Fire Technology Courses

FIRE 101 FUNDAMENTALS OF FIRE SERVICE OPERATIONS

Units: 3.0 CSU | 48-54 hours lecture

(No prerequisite)

Provides the student with the fundamentals of fire department organization, management, and resources, and emphasizes the use of those resources to control various emergencies.

FIRE 102 FIRE PREVENTION TECHNOLOGY

Units: 3.0 CSU | 48-54 hours lecture

(No prerequisite)

This course provides fundamental information regarding the history and philosophy of fire prevention, organization and operation of a fire prevention bureau, use of fire codes, identification and correction of fire hazards, and the relationship of fire prevention with fire safety education and detection and suppression systems.

FIRE 103 FIRE PROTECTION SYSTEMS

Units: 3.0 CSU | 48-54 hours lecture

(No prerequisite. Recommended preparation: FIRE 100)

This course provides information relating to the features of design and operation of fire detection and alarm systems, heat and smoke control systems, special protection and sprinkler systems, water supply for fire protection and portable fire extinguishers.

FIRE 104 FIRE BEHAVIOR AND COMBUSTION

Units: 3.0 CSU | 48-54 hours lecture

(No prerequisite)

This course will study the theory and fundamentals of how and why fires start, spread, and are controlled; an in-depth study of fire chemistry and physics, fire characteristics of materials, extinguishing agents, and fire control techniques.

FIRE 105 BUILDING CONSTRUCTION FOR FIRE PROTECTION (Formerly FIRE 69)

Units: 3.0 CSU | 48-54 hours lecture

(No prerequisite)

This course provides the components of building construction that relate to fire and life safety. The elements of construction and design of structures are shown to be key factors when inspecting buildings, pre-planning fire operations, and operating at emergencies.

FIRE 107 FIRE INVESTIGATION

Units: 3.0 CSU | 48-54 hours lecture

(No prerequisite)

A study of the origin of any and all types of fires (accidental, incendiary, and suspicious); and law relating to fire investigation. Recognizing, collecting, and preserving evidence, interviewing witnesses and suspects, arrest and detention procedures, court procedures and giving a testimony.

FIRE 108 FIRE HYDRAULICS

Units: 3.0 CSU | 48-54 hours lecture

(No prerequisite)

Review of applied mathematics; hydraulics laws as applied to the fire service; application of formulas and mental calculation to hydraulics and water supply problems.

FIRE 109 WILDLAND FIRE CONTROL

Units: 3.0 CSU | 48-54 hours lecture

(No prerequisite)

This course is designed to provide students with a fundamental knowledge of the factors affecting wildland fire prevention, fire behavior, and control techniques.

Fire Technology Courses

FIRE 110 PRINCIPLES OF FIRE AND EMERGENCY SERVICES SAFETY AND SURVIVAL (Formerly FIRE 68)

Units: 3.0 **CSU** | 48-54 hours lecture

(No prerequisite)

This course introduces the basic principles and history related to the national firefighter life safety initiatives, focusing on the need for cultural and behavioral change throughout the emergency services.

FIRE 121 FIRE MANAGEMENT 2B

Units: 2.0 **CSU** | 32-36 hours lecture

(No prerequisite)

This course is designed to provide information and insight into the cyclical nature of budgeting and financial management. As a management course, the student will be presented with the essential elements of financial planning, budget preparation, budget justification, and budget controls. This course applies to Chief Officer Certification.

FIRE 138 COOPERATIVE EDUCATION

See Cooperative Education listing. Units: 1-8 **CSU**

FIRE 148 SPECIAL TOPICS

See Special Topics listing. Units: Variable units **CSU**

FIRE 149 INDEPENDENT STUDY

See Independent Study listing. Units: 1-3 units **CSU**

The study of French concentrates on explaining and communicating ideas and concepts by means of reading, writing, and verbal processes through creative use of words and study of culture, literature, and civilization, with classroom emphasis on the spoken language. This study affords insight into foreign attitudes and methods and encourages free communication, written and oral, among people.

Career Opportunities

Advertising, Education, Government, Health Services, International Business, Journalism, Law Enforcement, Publishing, Social Work, Writing

Degrees and Certificates Awarded

Associate in Arts, Liberal Arts

Associate Degree

No associate degree offered with a major in French. French courses may be used to fulfill requirements for an Associate in Arts degree with a major in Liberal Arts. See Liberal Arts for degree requirements for this major.

Transfer

For the most up-to-date information on these programs and others, visit www.assist.org. Please stop by the Transfer Center in Building 55 or make an appointment with a counselor if you have questions.

- *California State University, San Bernardino: French major*
- *University of California, Riverside: French major*

French Courses

FREN 101 ELEMENTARY FRENCH

Units: 5.0 *CSU,UC* | 80-90 hours lecture

(No prerequisite)

Basic structures of French language, inductive presentation of grammar, simple composition. Emphasis placed on the spoken language.

FREN 102 ELEMENTARY FRENCH

Units: 5.0 *CSU,UC* | 80-90 hours lecture

(Prerequisite: FREN 101)

Continuation of FREN 101 stressing review of basic structures, more advanced grammar, spoken and written communication.

FREN 103 INTERMEDIATE FRENCH

Units: 3.0 *CSU,UC* | 48-54 hours lecture

(Prerequisite: FREN 102)

Continuation of FREN 102 with grammar review and expansion, introduction to simple literary texts, spoken and written communication.

FREN 104 INTERMEDIATE FRENCH

Units: 3.0 *CSU,UC* | 48-54 hours lecture

(Prerequisite: FREN 103)

Continuation of FREN 103 with further grammar review and expansion, reading of simple literary texts, spoken and written communication.

French Courses

FREN 125 CONVERSATIONAL FRENCH

Units: 3.0 *CSU* | 48-54 hours lecture

(No prerequisite. Grade Option)

An introduction to the French language using situations the visitor will commonly encounter. Introduction to simple French structures and grammar with emphasis on the spoken language.

FREN 128 SPECIAL TOPICS

See Special Topics listing. Units: Variable units *CSU*

FREN 129 INDEPENDENT STUDY

See Independent Study listing. Units: 1-3 units *CSU*

Geography

Geography is a spatial science that explains and describes the Earth in terms of location. All Geographers ask questions about the earth focusing on the location of a place and how that location contributes to the attributes of that place. Place names serve as the framework for this exploration. The primary tools used by geographers are maps, which show the locations, patterns and distribution of the earth features being examined. All geographers compare and contrast this locational information in order to explain the similarities and differences of the physical and cultural environments of the earth and its inhabitants. As a result, geographers are also called spatial analysts. The discipline of Geography is considered a Social and Global Science

There are two broad categories of Geography: Physical and Cultural. Physical geographers look at the earth's physical characteristics. Included are such topics that relate to the earth's natural environment such as earth-sun relationships, weather and climate, flora and fauna, rocks and minerals, earthquakes, volcanoes, mountain building, gradational forces and land form distribution. Cultural Geographers examine the present-day earth in terms of its people, their organizations, languages, religions, economic systems, population and settlement patterns.

Cultural Geographers examine the present-day earth in terms of its people, their organizations, languages, religions, economic systems, population and settlement patterns.

Geography courses are transferable to CSU, UC, and may be used to fulfill requirements for an Associate of Arts for Transfer with a major in Geography and/or Liberal Arts AA and /or various certificates. See VVC Certificates offered.

Career Opportunities

Geographic Information Systems is a rapidly growing field which can apply to many employment settings. Geographers are especially equipped to perform the spatial analysis required by Geographic Information Systems.

Most of the following career paths require at least a specific certificate or a bachelor's degree.

Aerial Photographer, Interpreter, Bio geographer, Cartographer, City Planner, Climatologist, County Planner, Demographer, Educator, Environmental Analyst, Economist, GIS Specialist, Government Analyst, Hydrologist, Industrial Location Specialist, International Trade Relations, Marketing Analyst, Meteorologist, Paleo climatologist, Natural Resource Planner, Soil Scientist, Transportation Specialist, Travel Specialist

Faculty

Carol A. DeLong - Emeritus

Degrees and Certificates Awarded

Associate in Arts, Liberal Arts

Associate in Arts for Transfer, Geography

Associate Degree

To earn an Associate in Arts degree for Transfer with a major in Geography (33025), complete the required major courses and all other requirements specified on the pages (i.e. 60 CSU transferable units, CSU GE or IGETC, etc.). For more information on the AA-T/AS-T degrees, meet with a counselor or www.adegreewithaguarantee.com

Program Learning Outcomes

- Identify and describe basic concepts and patterns related to earth's physical and cultural environment. KNOWLEDGE
- Demonstrate geographic literacy and written competency in the description and analysis of geographic themes. CRITICAL THINKING
- Demonstrate competency in utilizing the basic tools and techniques of data collection, display and analysis. APPLICATION

Transfer

For the most up-to-date information on these programs and others, visit www.assist.org. Please stop by the Transfer Center in Building 55 or make an appointment with a counselor if you have questions.

- **California State University, San Bernardino:**
 Geography – Geography Option B.A.
 Geography – Global Studies Option B.A.
- **University of California, Riverside:**
 Geography major Global Studies B.A.
- **University of California, Los Angeles:**
 Global Studies B.A.
- **University of California, Santa Barbara:**
 Geography – Geographic Information Science Emphasis B.A.
 Geography B.A. Physical Geography B.S.
 Physical Geography B.S.

Geography, AA-T (33025)		
Students who complete an Associate in Arts in Geography for Transfer Degree will be prepared to transfer into the CSU system and continue toward a BA in Geography. This Bachelor's degree prepares students for many career paths that deal with both the physical and /or cultural attributes of our globe. Courses in Geography offer students a unique perspective on global issues and problems dealing with the earth's physical environment and its inhabitants. Included are concepts that allow students to learn the geographer's special skill of analyzing spatial relationships using tools such as maps, GIS (Geography Information Systems), GPS (GeoPosition Satellites) remote sensing, spatial data and quantitative statistics. An Associate in Arts in Geography for Transfer Degree from Victor Valley College offers a wide overview and foundation for future study in not only geography but other social and physical sciences. Geographers make significant contributions in many professions and work in all areas of the public and private sector. Anyone with a degree in Geography, can continue their academic career with confidence knowing that they are prepared to proceed in any field that deals with our globe and its people.		
Program Requirements: 20 units		
Required Courses (7 units total)		
GEOG 101	Introduction to Physical Geography	3.0
GEOG 101L	Geography Laboratory	1.0
GEOG 102	Introduction to Cultural Geography	3.0
Additional Courses		
List A –Select TWO of the following courses (6 units total)		
GEOG 103	Geography of California	3.0
GEOG 104	World Regional Geography	3.0
List B – Select TWO (7 units)		
ANTH 102	Introduction to Cultural Anthropology	3.0
GEOG 130	Introduction to Weather and Climate	4.0
A student wishing to pursue an AA-T/AS-T degree in the major listed on this page must ensure the CSU of their choice is accepting that similar major. Students completing an AA-T/AS-T degree are guaranteed admissions into a CSU campus given that a student fulfills the following: 1) 60 CSU transferable units; 2) Completes the CSU General Education (GE) or IGETC General Education pattern; 3) Completes the major requirements for the AA-T/AS-T; 4) Maintains a transferable cumulative GPA of at least 2.0 (C or better); 5) Completes the basic/Golden 4 GE requirements. For more information on the AA-T/AS-T degrees, meet with a counselor or visit www.adegreewithaguarantee.com		

GEOG 101 INTRODUCTION TO PHYSICAL GEOGRAPHY

Units: 3.0 **CSU, UC** | 48-54 hours lecture

(No prerequisite.)

An introduction to the fundamental concepts of geography with emphasis on the physical world, its components and interrelationships. Topics include earth/sun relationships, atmospheric elements and weather, climate and seasons, earthquakes and volcanoes, rocks and minerals, oceans and coastlines, glaciers, and landform distribution. Also included are introductory methods of map reading and interpretation. Current environmental issues relating to these topics are emphasized.

GEOG 101L GEOGRAPHY 1 LABORATORY

Units: 1.0 **CSU, UC** | 48-54 hours laboratory

(No Prerequisite: Co-requisite: GEOG 101)

An interactive exploration of earth's weather and climate, vegetation and soils, rocks and minerals, earthquakes and volcanoes. Tectonic forces are studied as relating to landform destruction and creation. Gradational forces are studied as relating to the processes of water, wind and ice.

GEOG 102 INTRODUCTION TO CULTURAL GEOGRAPHY

Units: 3.0 **CSU, UC** | 48-54 hours lecture

(No prerequisite)

An examination of human activities on the surface of the earth as exhibited by various cultures. Global variations in land-use systems, settlement patterns, economic activities, political and religious institutions, languages, and the numbers and movement of human populations are explored.

GEOG 103 GEOGRAPHY OF CALIFORNIA

Units: 3.0 **CSU, UC** | 48-54 hours lecture

(No prerequisite)

Study of California's physical and cultural characteristics. Physical topics covered include earthquakes, fires, landslides, floods and volcanoes. Cultural topics include diversity, immigration, urbanization, agriculture and economics.

GEOG 104 WORLD REGIONAL GEOGRAPHY

Units: 3.0 **CSU, UC** | 48-54 hours lecture

(No prerequisite)

An examination of the world's countries within their global regions with emphasis on their physical and cultural attributes. Variations within and among these global regions are explored.

GEOG 106 MAP INTERPRETATION AND ANALYSIS

Units: 3.0 **CSU** | 48-54 hours lecture

(No prerequisite)

Introduction to maps, images and geographic techniques. Technologies include map and aerial photograph interpretation, tabular data, spatial statistics, cartography, Global Positioning Systems (GPS), Internet mapping, remote sensing and Geographic Information Systems (GIS) that aid in data collection, analysis and presentation.

GEOG 110 INTRODUCTION TO GEOGRAPHIC INFORMATION SYSTEMS (GIS)

Units: 3.0 **CSU, UC** | 48-54 hours lecture

(No prerequisite)

GIS basics and applications are explored, including terminology, mapping and problem solving. Current GIS software applications and GPS navigational systems are utilized.

GEOG 128 SPECIAL TOPICS

See Special Topics listing. Units: Variable units **CSU**

GEOG 130 INTRODUCTION TO WEATHER AND CLIMATE

Units: 4.0 **CSU** | 48-54 hours lecture and 48-54 hours laboratory

No prerequisite)

An examination of Earth's weather and climate systems including seasonal changes in solar radiation, temperature, barometric pressure, wind, atmospheric moisture, condensation, precipitation, air masses, fronts and mid-latitude cyclones. Tornadoes and hurricanes, weather forecasting, climate and climate change also included.

Geological Sciences

Geology is the study of the rocks and minerals of the earth and the external and internal processes that create earth's landforms. Geologists work to describe and explain how our planet evolved and how each particular environment is unique as to its formation. The discipline of Geology takes from other disciplines such as chemistry, biology, geography, mineralogy, meteorology, paleontology, oceanography and astronomy in order to explain earth's physical processes. Coursework in those disciplines, integrated within a geological framework, provides students with a broad, marketable understanding of earth's processes. Fieldwork is often included in geological study, especially at the universities. This fieldwork helps students understand how to assess geological processes within a local environment.

Geologists go on to work for environmental and mining companies as well as planning organizations and building companies. A bachelor's degree is recommended for students planning to become professional geologists employed by environmental and geo-technical firms, governmental agencies, and oil and mining companies and for students planning to pursue a graduate degree in geology.

At VVC the geological sciences are offered as lower division coursework counting toward an associate degree and prepares the student for advanced study at the University

Career Opportunities

Mining Geologist, Environmental Planner, Ground Water Quality Manager, Petroleum Engineer, Paleontologist, Geoarchaeologist, Geological Engineer, Soil Conservationist, Metallurgist, Exogeologist (Astrogeologist), Geomorphologist

Degrees and Certificates Awarded

Associate in Arts, Liberal Arts
Associate in Science, Math/Science

Associate Degree

No associate degree offered with a major in Geological Sciences. Courses in Geological Sciences may be used to fulfill requirements for an Associate in Science degree with a major in Math/Science or an Associate of Arts degree with a major in Liberal Arts. Please see respective listings for details on those majors

Transfer

For the most up-to-date information on these programs and others, visit www.assist.org. Please stop by the Transfer Center in Building 55 or make an appointment with a counselor if you have questions.

- **California State University, San Bernardino:** Geology major
- **University of California, Riverside:** Geology major, and Geophysics major

Geological Sciences Courses

GEOL 101 PHYSICAL GEOLOGY

Units: 4.0 **CSU, UC** | 48-54 hours lecture and 48-54 hours laboratory

(No prerequisite)

The study of geology is explored, including theories, principles and applications. Exploration includes, but is not limited to, minerals, rocks, weathering processes, seismic activity, and tools used by geologists. Field trips are scheduled to areas of representative local geology.

GEOL 128 SPECIAL TOPICS

See *Special Topics listing*. Units: Variable units **CSU**

GEOL 129 INDEPENDENT STUDY

See *Independent Study listing*. Units: 1-3 units **CSU**

Guidance classes offered at Victor Valley College are designed to assist students in becoming goal directed and successful. Students needing help in identifying career and educational goals or help in applying successful learning and studying techniques are encouraged to sign up for these classes.

Guidance Courses

GUID 50 COLLEGE SUCCESS

Units: 1.0 | 16-18 hours lecture

(No prerequisite. Grade Option)

This survey course is designed to introduce personal management and study techniques that are commonly applied among successful college students, with an emphasis on concepts such as the learning process, time management, note taking, efficient textbook reading, memory development and effective test-taking. It also serves as an orientation to college procedures and available campus resources.

GUID 51 ORIENTATION TO COLLEGE

Units: 0.5 | 8-9 hours lecture

(No prerequisite. Grade Option)

This class is designed to provide students with a well-rounded knowledge and orientation to the policies, procedures, and academic and support services available at Victor Valley College. Students will develop an educational plan relevant to their educational/career goals. It will introduce and help students understand major and general education, certificate, AA, and transfer requirements; identify the four-year college system (CSU, UC, and private); understand the financial aid process, and will allow students to develop and identify academic/career goals.

GUID 55 BUILDING MATH CONFIDENCE

Units: 1.5 | 24-27 hours lecture

(No prerequisite Grade Option)

A group guidance program designed for those who fear math and/or are unable to deal with math successfully. Emphasis will be on how one approaches math by examining attitudes and dispelling faulty notions which erode confidence in one's ability to do math.

GUID 56 SELF ESTEEM

Units: 1.5 | 24-27 hours lecture

(No prerequisite. Grade Option)

This personal development course focuses on specific ideas and techniques to overcome negative feelings such as loneliness, guilt, depression, and inferiority. Students will develop a personal value system that leads to greater happiness and productivity.

GUID 59 SPECIAL ISSUES IN PERSONAL DEVELOPMENT

Units: 1.0 | 16-18 hours lecture

(No prerequisite. Grade Option)

Opportunities for an examination of the elements associated with particular issues of personal development and various topics of student concern.

GUID 66 PEER ADVISING TECHNIQUES

Units: 3.0 | 48-54 hours lecture

(No prerequisite. Pass/No Pass)

This course is designed to provide peer advising techniques, familiarize students with campus policies and procedures, student rights and responsibilities, and campus resources, and to develop helping skills that will prepare peer advisors to assist other students.

Guidance Courses

GUID 100 CAREER AND LIFE PLANNING

Units: 2.0 **CSU** | 32-36 hours lecture

(No prerequisite. Grade Option)

This group guidance course is designed to assist students in the career and life planning process through consideration of individual needs, personality, interests, abilities and values. Emphasis will be placed on personal growth through assessment, career research, goal setting, and decision making.

GUID 101 FIRST YEAR EXPERIENCE

Units: 3.0 **CSU, UC** | 48-54 hours lecture

(No prerequisite. Recommended Preparation: Eligibility for ENGL 50. Grade Option)

This comprehensive course integrates personal growth, academic and career success with problem solving, critical and creative thinking. The course focuses on the following topics: life management, goal setting, career decision making, educational planning, college requirements and expectations, instructor-student interaction, cultural diversity, health maintenance, stress management, campus resources, learning styles, and strategies including lecture note-taking, test taking, and concentration.

GUID 105 PERSONAL & CAREER SUCCESS

Units: 3.0 **CSU, UC** | 48-54 hours lecture

(No prerequisite. Recommended Preparation: ENGL 50 with a grade of "C" or better or eligibility for ENGL 101.0. Grade Option)

This intensive course is designed to assist students in obtaining the skills and knowledge necessary to identify and reach their personal goals and achieve college and career success. Topics covered include: self-awareness, goal-setting, motivation and discipline, memory development, time management, oral and written communication skills, study skills, diversity, financial planning, and an orientation to college life.

GUID 107 LEARNING STRATEGIES AND STUDY SKILLS

Units: 3.0 **CSU** | 48-54 hours lecture

(No prerequisite. Recommended Preparation: Completion of ENGL 50 or eligibility for ENGL 101.0. Grade Option)

This survey course assists students in assessing attitude, motivation, learning styles, and personality attributes that are necessary to the successful transition into college. Students will integrate this self-awareness with theories and strategies that focus on the attainment of life long success in academic, professional and personal development. Topics include time management, study skills, test preparation, educational goal setting and planning, maintaining a healthy life style, and critical thinking skills.

Other areas of study in Kinesiology include: nutrition as well as understanding problems in community health. Courses in this area create an environment that enables students to understand and address their own health issues and risks for chronic illnesses.

Health Courses

HLTH 102 CONTEMPORARY PROBLEMS IN PERSONAL AND COMMUNITY HEALTH

Units: 3.0 *CSU, UC* | 48-54 hours lecture

(No prerequisite, Grade Option)

An introductory course emphasizing the scientific basis for making rational decisions on contemporary health problems of personal and social significance. Course includes personal nutrition, fitness, reproduction, and disease control. The course also includes a review of other current issues of community health.

Health 102 satisfies VVC's P.E. requirement in addition to any other requirements it may fulfill.

HLTH 202 NUTRITION FOR FITNESS

Units: 3.0 *CSU, UC* | 48-54 hours lecture

(No prerequisite. Grade Option)

Nutrition is an integral part of fitness. Explore the effects of proteins, fats, carbohydrates, water, minerals and vitamins on fitness and health.

History

History examines the processes that have made today's realities. History is an evolving record of emotion, aspiration, frustration, and success. Historians deal with the goals, fears, interests, opinions, and prejudices of people in the past. What made people the way they were? What is the impact of their thought and action on people today and what is their impact on people tomorrow? As a study of people, history offers both a necessary understanding of one's place in the human experience and the conceptual framework for a lifelong avocation.

Recommended Preparation: As there is substantial reading and writing in all history courses, it is strongly suggested that students complete English 45 or higher before enrolling in history courses.

Program Learning Outcomes

A student receiving a degree or certificate in this field will be able to:

- Identify and analyze key historical terms, including historiographical contexts.
- Discuss significant people, institutions and events, using primary and secondary source materials.
- Demonstrate analytical skills in interpreting historical documents and source materials to construct logical arguments about past events and their impact on the future.

Career Opportunities

Careers usually require bachelor's or advanced degrees.

Advertising/Marketing Research, Archivist/Museum Curator, Educator, Genealogist, Historian, Journalist/Writer/Editor, Lobbyist/Law Clerk/Lawyer, Management Trainee, Politician/Diplomat, Pollster, Professor, Reference Librarian, Risk Analyst, Researcher, Teacher, Writer

Faculty

Tracy Davis | Lisa Ellis | Eric Mayer

Degrees and Certificates Awarded

Associate in Arts, Liberal Arts

Associate in Arts in for Transfer, History

Associate Degree

To earn an Associate in Arts degree for Transfer with a major in History, complete the required major courses and all other requirements specified on the following pages (i.e. 60 CSU transferable units, CSU GE or IGETC, etc.). For more information on the AA-T/AS-T degrees, meet with a counselor or www.adegreewithaguarantee.com

Transfer

For the most up-to-date information on these programs and others, visit www.assist.org. Please stop by the Transfer Center in Building 55 or make an appointment with a counselor if you have questions.

- **California State University, San Bernardino:** History major
- **University of California, Riverside:** History major

History, AA-T (31788)		
Students completing an Associate in Arts for Transfer in History Transfer will be prepared to transfer into the CSU system to continue toward a BA in History or a combined Social Sciences Degree, as well as a general Liberal Arts Degree. The degree is for students who seek to understand the past and strive to develop a historical sense. With course offerings covering much of the past from all parts of the globe, from the ancient world to the present, the program offers the foundation for a broad education. Such a foundation has been preparing students since the founding of the school in 1961 for careers in education, politics, the law, public administration, librarianship, and many other disciplines. This program offers students an in-depth and diverse framework of traditional humanistic skills, the chief being critical reading, good writing, and the analyses of historical texts. We offer expertise in such areas as the history of the Latin America, Native American, and Women in US History, as well as the traditional survey courses in U.S. and World History.		
Program Requirements: 18 units		
Required Courses (6 units total)		
HIST 117/H117	History of the U.S. to 1876	3.0
HIST 118/H118	History of the U.S. from 1876	3.0
Additional Courses		
List A – (6 units total)		
HIST 103	World History to 1500	3.0
HIST 104	World History Since 1500	3.0
List B – Group 1 Select any ONE of the following courses (3 units total)		
HIST 130	Latin American History	3.0
HIST 131	Latin American History	3.0
HIST 155	Women in History	3.0
HIST 157	Native American History	3.0
List B – Group 2 Select any ONE of the following courses (3 units total)		
ANTH 102	Introduction to Cultural Anthropology	3.0
ECON 101	Principles of Economics: Macro	3.0
ECON 102	Principles of Economics: Micro	3.0
SOC 101	Introduction to Sociology	3.0
SOC 107	Ethnic Experience in American Society	3.0
GEOG 102	Introduction to Cultural Geography	3.0
POLS 102	Introduction to American Government and Politics	3.0
PSYC 101/H101	Introductory Psychology	3.0
A student wishing to pursue an AA-T/AS-T degree in the major listed on this page must ensure the CSU of their choice is accepting that similar major. Students completing an AA-T/AS-T degree are guaranteed admissions into a CSU campus given that a student fulfills the following: 1) 60 CSU transferable units; 2) Completes the CSU General Education (GE) or IGETC General Education pattern; 3) Completes the major requirements for the AA-T/AS-T; 4) Maintains a transferable cumulative GPA of at least 2.0 (C or better); 5) Completes the basic/Golden 4 GE requirements. For more information on the AA-T/AS-T degrees, meet with a counselor or visit www.sb1440.org and www.adegreewithaguarantee.com		

History Courses

HIST 103 WORLD HISTORY TO 1500

Units: 3.0 **CSU, UC** | 48-54 hours lecture

(No prerequisite)

Course will focus on the beginnings of civilization some five to seven thousand years ago in Mesopotamia, Asia, the Americas, Classical Civilizations and the Axis Age with an understanding of the world in 1500. Social, cultural, geographical, political and economic history of the various world civilizations will be stressed. The course is designed to challenge erroneous assumptions about world history and contemporary realities.

HIST 104 WORLD HISTORY SINCE 1500

Units: 3.0 **CSU, UC** | 48-54 hours lecture

(No prerequisite)

Course will cover the period of 1600 to the 1980's and will focus on the making of the modern world. Inter-locking themes will include the discovery of the New World and the rise of Capitalism, the resistance to this new economic system by the non-white world, the spread of Imperialism and the division of the world in the "core" (industrial) and "peripheral" (non-industrial) nations of the First and Third World. National revolution and rebellion especially in the 20th century will be examined as well as the "end of the Third World" and the rise of the Pacific Rim as a model of national and economic development.

HIST 115 HISTORY OF CALIFORNIA

Units: 3.0 **CSU, UC** | 48-54 hours lecture

(No prerequisite)

A survey of the history and geography of California. The course will cover all aspects of the development of what is today known as California, including those contributions made by Indians, Spanish, Mexican, and early Anglo inhabitants. Special emphasis will be laid upon critical issues of the present. This course satisfies in part the California history requirement for teachers in the primary grades.

HIST 117 HISTORY OF THE UNITED STATES TO 1876

Units: 3.0 **CSU, UC** | 48-54 hours lecture

(UC credit limitation). (No prerequisite.)

American Civilization through the Civil War era. Native American and European antecedents will be studied. Colonial and revolutionary periods will be analyzed as well as the formation of a new nation. Gender and race issues will be examined in the light of nation building.

HIST 117H HONORS US HISTORY TO 1876

Units: 3.0 **CSU, UC** | 48-54 hours lecture

(No prerequisite. Recommended preparation: ENGL 101)

American civilization, encompassing the Pre-Columbian American experience through the Civil War era. The class examines gender and race issues in light of nation building and American culture. Honors classes will take students further in the course material with additional reading, emphasis on research, and exploring historiographical frameworks used in interpreting history.

HIST 118 HISTORY OF THE UNITED STATES FROM 1876

Units: 3.0 **CSU, UC** | 48-54 hours lecture

(No prerequisite) (UC credit limitation)

A survey of the history of the United States from 1876 to the present. The course will focus on economic, political and social history in order to understand the casual factors that created the United States. Gender and ethnic history will be examined in light of the development of the United States and how diverse groups contributed to the historical reality of the United States.

HIST 118H HONORS HISTORY OF THE UNITED STATES FROM 1876

Units: 3.0 *CSU, UC* | 48-54 hours lecture

(No prerequisite. Recommended preparation: ENGL 101.0 or ENGL 101H) (UC credit limitation)

A survey of American history since Reconstruction with emphasis on social, political, diplomatic, intellectual and economic factors which shaped modern America. As an Honors designated course, students should be aware that additional reading and discussion, in addition to various supplement materials, could be required. Particular attention will be focused on the varying viewpoints and interpretations of the important historic questions.

HIST 130 LATIN AMERICAN HISTORY

Units: 3.0 *CSU, UC* | 48-54 hours lecture

(No prerequisite)

This course is designed to give students a chronological overview of Latin American History beginning with pre-Colombian societies and concluding with Latin American Independence. Focuses on the impact of the conquest of the “New World”, the role of the Catholic Church, Spanish mercantilism, and the *encomienda* system, on the indigenous population and the development of Latin American society.

HIST 131 LATIN AMERICAN HISTORY

Units: 3.0 *CSU, UC* | 48-54 hours lecture

(No prerequisite)

This course is designed to give students a chronological overview of Latin American History beginning with Latin American Independence and concluding with present events and problems in Latin America. Students will gain an understanding of the social, economic, political, and diplomatic elements that have been the basis for post-Independence Latin American development. Special emphasis will be placed on US-Latin American relations.

HIST 155 WOMEN IN U.S. HISTORY

Units: 3.0 *CSU, UC* | 48-54 hours lecture

(No prerequisite)

History of women in the United States from early colonial era to the present. This course must assume some understanding of the formative events in U.S. history and will focus on the changing roles women have played in society, family, and work.

Honors

The honors program offers enriching experiences to improve the quality of education for academically talented students who are striving for advanced academic achievement. Honors courses are more extensive and intensive in terms of research, depth of discussion and material covered. They are designed to promote a deeper, more comprehensive understanding of the material and the connectedness of disciplines while preparing students to excel later in advanced degree preparation. They offer additional opportunities for independent and focused study, and more individualized interdisciplinary, experimental, enhanced and collaborative learning experiences. Students participate in advanced seminars and intensive research and course work. Students should be self-motivated and must have demonstrated superior academic achievement in either high school or college.

Victor Valley College is a member of the Honors Transfer Council of California. This membership can provide students with numerous scholarship and financial aid opportunities, as well as possible transfer advantages to participating universities, such as UCLA, UCR, UCI, Whitman College and many others.

For enrollment criteria or any other information contact the Honors Coordinator at (760) 245-4271, ext. 2691.

Honors Courses

BIOL 295H UNDERGRADUATE RESEARCH I – SCIENTIFIC COMMUNICATION

Units: 3.0 **CSU** | 48-54 hours lecture

(Prerequisites: Prerequisite: BIOL 100, H100, BIOL 107 or BIOL 201; minimum grade C.)

If the goal of science is to contribute to our understanding of the natural world, then the goal of scientific writing is to communicate that understanding with precision, accuracy, and economy. In this course, you will develop your skills as a writer of scientific research, skills that will contribute to your learning of course material and to creating your identity as a scientist. You will explore the genre of the research article and its components and develop an understanding of the material. In addition, you will develop your skills as a writer, reviser, and editor—working with your peers and your instructor—and, ultimately, develop a solid foundation for writing your future research work.

BIOL 296H UNDERGRADUATE RESEARCH II – EXPERIMENTAL DESIGN

Units: 4.0 **CSU** | 48-54 hours lecture and 48-54 hours laboratory

(Prerequisites: Prerequisite: BIOL 100 or H100, BIOL 107, BIOL 201, BIOL 202, BIOL 221 or BIOL 231; minimum grade C.)

This course allows students to select a research project, write a literature review and research proposal, conduct preliminary experiments, and write a research report. Research methods and experimental design will be emphasized, including the location and study of articles from the professional literature. Undergraduate research helps students develop valuable skills, and provides students with an opportunity to apply scientific knowledge in the context of “real world” problems. Participation will also open up opportunities for students to take part in analyzing data and conducting field research.

ENGL 101H HONORS ENGLISH COMPOSITION AND READING

Units: 4.0 **CSU, UC** | 64-72 hours lecture

(Prerequisite: ENGL 50 minimum grade C.)

Principles and methods of expository writing. Analytical reading of source materials and writing of expository essays. Honors seminar will require more advanced resources and more complex assignments than ENGL 101.0.

ENGL 102H HONORS COMPOSITION AND LITERATURE

Units: 3.0 **CSU, UC** | 48-54 hours lecture

(Prerequisite: ENGL 101.0 or ENGL 101H minimum grade C.) (UC credit limitation)

Further training in writing and introduction to the short story, novel, poetry, and drama. This course takes the methods of English 102 and promotes more comprehensive analysis, research, discussion and writing assignments.

ENGL 104H HONORS CRITICAL THINKING AND COMPOSITION

Units: 3.0 **CSU, UC** | 48-54 hours lecture

(Prerequisite: ENGL 101.0 or ENGL 101H minimum grade C.)

This course is designed to develop the students' critical thinking, reading and writing skills beyond the level achieved in ENGL 101.0 or ENGL 101H. It will focus primarily on the analysis and evaluation of expository and argumentative essays. Honors seminar will deepen students' insights.

HIST 117H HONORS HISTORY OF THE UNITED STATES TO 1876

Units: 3.0 **CSU, UC** | 48-54 hours lecture

(No prerequisite. Recommended preparation: ENGL 101.) (UC credit limitation.)

American civilization, encompassing the Pre-Columbian American experience through the Civil War era. The class examines gender and race issues in light of nation building and American culture. Honors classes will take students further into the course material with additional reading, emphasis on research, and exploring historiographical frameworks used in interpreting history.

HIST 118H HONORS HISTORY OF THE UNITED STATES FROM 1876

Units: 3.0 **CSU, UC** | 48-54 hours lecture

(No prerequisite. Recommended preparation: ENGL 101.0 or ENGL 101H) (UC credit limitation)

A survey of American history since Reconstruction with emphasis on social, political, diplomatic, intellectual and economic factors which shaped modern America. As an Honors designated course, students should be aware that additional reading and discussion, in addition to various supplement materials, could be required. Particular attention will be focused on the varying viewpoints and interpretations of the important historic questions.

MATH 105H HONORS COLLEGE ALGEBRA

Units: 4.0 **CSU, UC** | 64-72 hours lecture

(Prerequisite: MATH 90 or MATH 90-S with a grade of "C" or better) (UC credit limitation)

This course covers all the topics of the regular Math 105 course, but the topics are covered in greater depth. Exponents and Radicals, Theory of Quadratic Equations, Simultaneous Quadratic Equations, Complex Numbers, Equations of Higher Degree, Inequalities, Logarithmic and Exponential Equations, Binomial Theorem, Matrices and Determinants, Partial Fractions, Sequences and Series.

MATH 120H HONORS INTRODUCTION TO STATISTICS

Units: 4.0 **CSU, UC** | 64-72 hours lecture

(Prerequisite: MATH 90, MATH 63 or MATH 66 minimum grade C.)

Basic statistical techniques, design and analysis for both parametric and non-parametric data are included. Descriptive statistics are included. Graphing techniques of illustrating the data are covered. Probability is covered. Inferential statistics included are estimation and hypothesis testing, chi-square, analysis of variance, and regression. Applications are drawn from a variety of fields. In addition, the Honors component will include the design of surveys, probability testing, and a research project.

MATH 129A-H INDEPENDENT STUDY HONORS – FIRST SEMESTER

Units: 1.0 **CSU** | 54 hours Independent Study

(No prerequisite)

Independent study provides individual students challenging and in-depth study on approved topics within any subject area. Independent study proposals must have the approval of the instructor and appropriate administrator. It is expected that the study will not duplicate existing curriculum; rather, it will be of an advanced nature and extend approved courses or series of courses. This first semester honors independent study course is intended to begin the study of advanced topics at an honors level.

Honors Courses

MATH 129B-H INDEPENDENT STUDY HONORS – SECOND SEMESTER

Units: 1.0 **CSU,** 54 hours Independent Study

(Prerequisite: MATH 129AH)

Independent study provides individual students challenging and in-depth study on approved topics within any subject area. Independent study proposals must have the approval of the instructor and appropriate administrator. It is expected that the study will not duplicate existing curriculum; rather, it will be of an advanced nature and extend approved courses or series of courses. This first semester honors independent study course is intended to begin the study of advanced topics at an honors level.

MATH 129C-H INDEPENDENT STUDY HONORS – THIRD SEMESTER

Units: 1.0 **CSU,** 54 hours Independent Study

(Prerequisite: MATH 129BH)

Independent study provides individual students challenging and in-depth study on approved topics within any subject area. Independent study proposals must have the approval of the instructor and appropriate administrator. It is expected that the study will not duplicate existing curriculum; rather, it will be of an advanced nature and extend approved courses or series of courses. This first semester honors independent study course is intended to begin the study of advanced topics at an honors level.

MATH 226H HONORS ANALYTIC GEOMETRY AND CALCULUS

Units: 4.0 **CSU,UC,** 64-72 hours lecture

(Prerequisite: MATH 104 and MATH 105 or MATH 105H with a grade of C or better, or placement by VVC assessment.) (UC Credit Limitation)

As an introduction to the calculus of single variables, students will develop the concept of limit; apply limits to functions to determine if they are continuous, find the derivative and determine integrals. Students will study the properties of the derivative and integral, their relationship to each other given by the Fundamental Theorem of Calculus. In addition, the honors component will include reading proofs, and writing simple proofs.

MATH 227H HONORS ANALYTIC GEOMETRY AND CALCULUS II

Units: 5.0 **CSU, UC** 64-72 hours lecture

(Prerequisite: MATH 226 or MATH 226H with a grade of 'C' or better.) (UC credit limitation)

The second course in differential and integral calculus of a single variable: integration; techniques of integration; infinite sequences and series; polar and parametric equations; applications of integration. In addition, the honors component will include reading proofs, writing complete proofs from sketches of proofs and applying techniques learned to real-life problems.

MATH 228H HONORS ANALYTIC GEOMETRY AND CALCULUS

Units: 4.0 **CSU, UC** 80-90 hours lecture

(Prerequisite: MATH 226 or MATH 226H with a grade of 'C' or better.) (UC credit limitation)

Vectors and the geometry of space, vector-valued functions, the calculus of functions of several variables, multiple integration, Green's Theorem, divergence theorem, Stoke's Theorem, and applications. In addition, the honors component will include reading proofs, writing complete proofs from sketches of proofs and apply techniques learned to real-life problems.

POLS 102H HONORS AMERICAN GOVERNMENT AND POLITICS

Units: 3.0 **CSU, UC** 48-54 hours lecture

(No prerequisite) (UC credit limitation)

Enhanced for honors students. This course is an introductory survey of American governing institutions, federal and state, and other elements of the political system. The course is issue-oriented, inviting students to analyze critically competing theories and arguments relating to the founding of the Republic (especially the development of the Constitution), federalism, individual rights and liberties, interest groups, political parties, voting behavior and elections, campaign finance reform, public policy options, and the operational relations among the executive, legislative, and judicial branches. Course curriculum recognizes the roles and contributions of racial and ethnic groups and women in American politics. On each of these topics comparisons will be made to the governing units and politics of California, as well as local government

Independent Study

IND STUDY 129-149-99 INDEPENDENT STUDY

Units: 1.0-3.0 - (Prerequisite: Formulation of a written statement of purpose acceptable to the instructor and demonstration of sufficient background and skill to undertake the project)

Independent Study has been designed to provide students with an opportunity for Individual study, research, or other projects under instructor guidance. Written reports and periodic conferences required. Content and unit credit to be determined by student/instructor conferences and/or departmental recommendation. Designed to provide an opportunity for qualified students to do individual study in a selected area of a subject field. The student may take up to a maximum of six units of Independent Study course work in a particular discipline. The Instructor is responsible for providing advice and guidance as required, and for evaluating student performance. Instructors providing Independent Study opportunities do so, on a voluntary basis.

Units are awarded according to the following formula of time committed to the course:

1 unit	54 hours per semester
2 units	108 hours per semester
3 units	162 hours per semester

CSU may limit the number of Independent Study units accepted.

UC maximum credit allowed: three and one-third semester credits per term, six units total, in any or all appropriate subject areas combined. Granting of course credit contingent upon an evaluation of the course outline by a UC campus.

CHECKLIST AND PROCEDURE:

- Proposed Independent Study Course has an approved course outline that is in compliance with Title V regulations.
- Discuss proposed Independent Study with Instructor. (Instructor must approve).
- Complete Independent Study contract and summary form for the course. (Available at the Division Dean's office).
- Attach a course syllabus to contract, obtain instructor signature and forward to appropriate Dean for signature.
- Dean's office will forward completed application package to the VP of Instruction for approval.
- Office of Instruction will provide a section number upon VPI approval of completed application and syllabus.
- If the contract is cancelled, the student must drop the class following standard drop procedures and dates.
- A copy of the contract must remain in the Instructor's files with all materials justifying the award of grade and completion of units for audit purposes.

Journalism

Journalism offers the interest and challenges of investigating and reporting current events and topics of interest. The discipline touches on every aspect of human affairs with the opportunity to specialize in areas such as politics, sports, economics, and international affairs. Journalistic skills demand good writing ability, creativity, curiosity, and commitment to exacting professional standards. While one typically thinks of journalists working for a newspaper, many excellent employment opportunities are offered with popular magazines, professional journals, business and industry newsletters, government agencies, and publishing houses.

Career Opportunities

Advertising Agency Executive, Community Relations Specialist, Copy Writer, Journalism, Promotions Manager
Public Information Officer, Publicity Director, Reporter, Television News Producer

Journalism Courses

JOUR 108 FUNDAMENTALS OF JOURNALISM

Units: 3.0 CSU | 48-54 hours lecture

(Prerequisite: ENGL 50 minimum grade C. Co-requisite: JOUR 108LA.)

This course covers the basics of news and feature reporting and writing, including interviewing techniques, legal/ethical issues, writing strategies, and desk-top publishing. Students produce the campus newspaper and learn about career opportunities.

JOUR 108LA JOURNALISM LAB A

Units: 1.0-3.0 CSU | 48-54 hours laboratory per unit

(Prerequisite: ENGL 50 minimum grade C. Co-requisite: JOUR 108.)

This is a laboratory class that requires JOUR 108 as a co-requisite. The students will improve their writing skills; learn techniques for copy editing, design, and layout; and learn the fundamentals of advertising, photo-journalism, business, and desk-top publishing as they apply to newspaper production and distribution.

JOUR 108LB JOURNALISM LAB B

Units: 1.0-3.0 CSU | 48-54 hours laboratory per unit

(Prerequisite: JOUR 108 AND JOUR 108LA minimum grade C.)

This laboratory-only course focuses on intermediate writing and producing the school newspaper, RamPage, and its Online version. Students will research, write, and edit articles for both publications. Students will also take photographs, design and/or layout pages, create graphic illustrations, and develop multimedia stories. Throughout this course, students will also apply media ethics and learn the fundamentals of media law. Leadership and management skills are also covered.

JOUR 108LC JOURNALISM LAB C

Units: 1.0-3.0 CSU | 48-54 hours laboratory per unit

(Prerequisite: JOUR 108 AND JOUR 108LB minimum grade C.)

This laboratory-only course focuses on intermediate writing and producing the school newspaper, RamPage, and its Online version. Students will research, write, and edit articles for both publications. Students will also take photographs, design and/or layout pages, create graphic illustrations, and develop multimedia stories. Throughout this course, students will also apply media ethics and learn the fundamentals of media law. Leadership and management skills are also covered.

JOUR 108LD JOURNALISM LAB D

Units: 1.0-3.0 CSU | 48-54 hours laboratory per unit

(Prerequisite: JOUR 108 AND JOUR 108LC minimum grade C.)

This laboratory-only course focuses on intermediate writing and producing the school newspaper, RamPage, and its Online version. Students will research, write, and edit articles for both publications. Students will also take photographs, design and/or layout pages, create graphic illustrations, develop multimedia stories and edit advanced investigative and in-depth articles for the two publications. Throughout this course, students will also apply media ethics and learn the fundamentals of media law. Leadership and management skills are also covered.

Journalism Courses

JOUR 138 COOPERATIVE EDUCATION

Units: 1-8 units [CSU](#)

See Cooperative Education listing

JOUR 128 SPECIAL TOPICS

Units: Variable units [CSU](#)

See Special Topics listing

JOUR 129 INDEPENDENT STUDY

Units: 1-3 units [CSU](#)

See Independent Study listing

Kinesiology (Formerly Physical Education)

Kinesiology as an academic science emphasizes knowledge of the body through the study of movement and exercise physiology. Kinesiology also contributes to the intellectual, social, emotional, spiritual and physical growth and development of each student. Other areas of study in Kinesiology include: nutrition, healthy lifestyles, stress management as well as psychological aspects of physical activity and injury care and prevention. Additional specialties within the discipline of Kinesiology which are more fully addressed in the curriculum at Victor Valley College are Dance and Adapted Physical Education. A variety of activities are offered, encouraging students to develop lifelong fitness activities and patterns for recreation.

With the exception of the Adapted courses, all Kinesiology activity classes are intended for normal, healthy, individuals. It is highly recommended that anyone 35 years or older have a physical checkup before enrolling. Physical Education is required for the Associate degree and all Kinesiology and Kinesiology-Dance courses fulfill this requirement..

UC maximum credit allowed for KIN courses combined: 4 units.

Career Opportunities

Adapted Physical Activity Instructor, Aquatics Director, Athletic Administration in School or College, Athletic Trainer, Biomechanist, Cardiac Rehabilitation Specialist, Coaching at School or College, Dance Choreographer, Dance Instructor, Director of Youth Camps/ Sport Programs, Epidemiologist – Physical Activity, Exercise Physiologist, Fitness Instructor or Program Director at Commercial, Fitness Center - Program Director of Corporate Fitness Center -Sports Director at Resort, Massage Therapist, Medical Doctor, Occupational Therapist, Personal Trainer, Physical Education Teacher at School or College, Physical Therapist, Physician's Assistant, Professor of Kinesiology, Physical Education, Recreational Therapist, Registered Nurse, Respiration Therapist, Sport Management, Sport Psychologist for Performance Enhancement, Sports Information Director, Sports Journalist, Sports Marketing, Sports Officiating, Strength and Conditioning Coach

Faculty

Debra Blanchard | Lynn Guardado | David Hoover
Bruce Victor | Christa White

Degrees and Certificates Awarded

Associate in Arts for Transfer, Kinesiology

Associate Degree

To earn an Associate in Arts degree for Transfer with a major in Kinesiology, complete the required major courses and all other requirements specified on the following pages (i.e. 60CSU transferable units, CSU GE or IGETC, etc.). For more information on the AA-T/AS-T degrees, meet with a counselor or www.adegreewithaguarantee.com.

Transfer

CSUSB has a popular program in this area:

- **California State University, San Bernardino:** Kinesiology major

Different concentrations within the Kinesiology major include Exercise Science, Pedagogy, and pre-physical therapy. For information about these options, visit www.assist.org.

Specialties in Exercise Physiology, Exercise Science, Fitness Training, and Sports Medicine are usually under the departments of Physical Education or Kinesiology at the four-year colleges. A major in Kinesiology may also lead to graduate programs in Physical Therapy at other institutions. See Sports Medicine under Medical and Health Professions for further information on these specific fields.

KINESIOLOGY, AA-T (35831)		
Program Requirements: 23-24 units		
Required Courses: Take all 3 courses		
BIOL 211	Human Anatomy	5.0
BIOL 231	Human Physiology	5.0
KIN 101	Introduction to Exercise Science and Kinesiology	3.0
Required Movement – Based Courses. 3 unit minimum. Select ONE course maximum from any three of the following areas:		
Area 1: Aquatics		
KIN 186A	Introduction to Aqua Aerobics	1.0
KIN 186B	Aqua Jogging	1.0
Area 2: Combatives		
KIN 168	Introduction to Self-Defense	1.0
Area 3: Dance		
TBA		
Area 4: Fitness		
KIN 150	Lifetime Physical Fitness Concepts	2.0
KIN 160	Physical Fitness	1.0
KIN 162	Weight Training I	1.0
KIN 163	Weight Lifting II	1.0
KIN 164	Aerobic Weight Training	1.0
Area 5: Individual Sports		
KIN 180A	Tennis	1.0
KIN 181	Introduction to Golf	1.0
Area 6: Team Sports		
KIN 165	Introduction to Basketball	1.0
KIN 166	Beginning Volleyball	1.0
KIN 166B	Beginning/Intermediate Volleyball	1.0
KIN 180B	Tennins Doubles	1.0
KIN 185	Football Techniques and Conditioning	2.0
KIN 185B	Offensive Football Techniques and Conditioning	1.0
List A: Select two – 6 units		
KIN 102	First Aid, AED and CPR	3.0
MATH 120/120H	Introduction to Statistics	4.0

Kinesiology Courses

KIN 101 INTRODUCTION TO EXERCISE SCIENCE AND KINESIOLOGY

Units: 3.0 **CSU** | 48-54 hours lecture

(No prerequisite. Grade Option.)

This course is an introduction to the interdisciplinary approach to the study of human movement. An overview of the importance of the sub-disciplines in kinesiology will be discussed along with career opportunities in the areas of teaching, coaching, allied health, and fitness professions.

KIN 102 FIRST AID, AED AND CPR

Units: 3.0 **CSU** | 48-54 hours lecture

(No prerequisite. Grade Option.)

This course involves the theory and detailed demonstration of the first aid care of the injured. The student will learn to assess a victim's condition and incorporate proper treatment. Upon successful completion of this course and testing, students receive an American Red Cross or American Heart Association First Aid, CPR, AED Course Completion Card that is valid for two years.

KIN 103 HISTORY AND APPRECIATION OF DANCE

Units: 3.0 **CSU, UC** | 48-54 hours lecture

(No prerequisite. Recommended preparation ENGL 101.0 or ENGL 101H. Grade Option.)

The origin, growth, and development of dance (theatrical, social and ritualistic forms) will be researched. A study of dances originating in many areas of the world will be covered. The class will research who, when, where, and how each dance originated. The class will trace dance from its origin to modern times.

KIN 104 PSYCHOLOGY OF PHYSICAL PERFORMANCE

Units: 3.0 **CSU** | 48-54 hours lecture

(No prerequisite. Grade Option)

An introduction to the discipline of sports psychology for students with no previous background in the field. Topics include: orientation to sports psychology, motivational techniques, individual differences and sport behavior, social-environmental influences and sports behavior, and intervention techniques and sports behavior.

KIN 105 DEVELOPMENTAL MOVEMENT OF CHILDREN

Units: 3.0 **CSU** | 48-54 hours lecture

(No prerequisite)

This course provides a comprehensive overview of theories and methods relating to the development of a physical education program for children ages 0-11 years including children with special needs and abilities. Emphasis is on the application of principles of physical growth and development to the teaching and acquisition of specific physical skills. The course curriculum is consistent with the California State Department of Education Physical Education Framework.

KIN 128 SPECIAL TOPICS

Units: 1.0-3.0 | 48-54 hours lecture

(No prerequisite)

This course is designed to permit investigation in depth of topics not covered by regular catalog offerings. Course content, hours, and unit credit to be determined by the instructor in relation to community/students interest and/or available staff may be offered as a seminar, lecture, or laboratory class. Individual course descriptions approved by the Curriculum Committee are on file in Office of Instruction.

KIN 141 ATHLETIC TRAINING I

Units: 3.0 **CSU, UC** | 32-36 hours lecture and 48-54 hours laboratory

(No prerequisite. Interest and/or experience in athletics and sports recommended.)

Introduction to principles of athletic training, including prevention, evaluation, treatment and rehabilitation of common athletic injuries. See cross listing for ALDH 141.

KIN 142 ATHLETIC TRAINING II

Units: 3.0 **CSU, UC** | 32-36 hours lecture and 48-54 hours laboratory

(Prerequisite: KIN/PE 141 or ALDH 141.)

This course will build on the student's basic knowledge of human anatomy and athletic injuries. Topics will include emergency procedures, current health concerns of the athlete, protective devices, advanced taping techniques and injury management. See cross listing for ALDH 142.

KIN 150 LIFETIME PHYSICAL FITNESS CONCEPTS

Units: 2.0 **CSU** | 16-18 hours lecture and 48-54 hours laboratory

(No prerequisite. Grade Option)

Designed to help the students understand the role of physical fitness in daily living. Students analyze and integrate individual fitness components into a personal fitness program level and participate in activities designed to improve overall fitness.

KIN 160 PHYSICAL FITNESS

Units: 1.0 **CSU, UC** | 48-54 hours laboratory

(No prerequisite. Grade Option)

Physical Fitness is an exercise course designed to emphasize fitness by offering the student a variety of exercises to include hand weights, exercise ball, aerobics and step aerobics which can be used to maintain fitness throughout life.

KIN 161 BODY BUILDING AND CONDITIONING

Units: 1.0 **CSU, UC** | 48-54 hours laboratory

(No prerequisite. Grade Option)

Evaluation of total body fitness and study of body mechanics in everyday activities. Establishing fitness goals and developing appropriate exercise fitness routines to build body proportions, strength, endurance, and flexibility.

KIN 162 WEIGHT TRAINING I

Units: 1.0 **CSU** | 48-54 hours laboratory

(No prerequisite. Grade Option)

Introduction to the basic techniques of weight training. The principles of strength development, the role of proper nutrition, the anatomy and physiology of muscles, and safety will be covered in class. Various weight lifting programs covering strength development, endurance, and body building will also be introduced.

KIN 163 WEIGHT LIFTING II

Units: 1.0 **CSU** | 48-54 hours laboratory

(No prerequisite. Grade Option)

A weight lifting course for those students who have been consistently participating in a weight lifting program for 6-12 months for at least three hours per week. This course is designed to emphasize continued individual growth in the areas of body building, body sculpturing and strength at an intermediate level.

KIN 164 AEROBIC WEIGHT TRAINING

Units: 1.0 **CSU** | 48-54 hours laborator

(No prerequisite. Grade Option)

Aerobic weight training combines strength and cardiovascular fitness training into a comprehensive weight training program that has as its major objective the development of all-around fitness. It offers measurable benefits to muscular strength, muscular endurance, body composition, flexibility, and cardiovascular/ aerobic fitness.

KIN 165 INTRODUCTION TO BASKETBALL

Units: 1.0 **CSU, UC** | 48-54 hours laboratory

(No prerequisite. Grade Option) (UC credit limitation)

An introduction to the basic skills, rules, and strategies of basketball including: catching, passing, shooting, and dribbling.

Kinesiology Courses

KIN 166 BEGINNING VOLLEYBALL

Units: 1.0 CSU | 48-54 hours laboratory

(No prerequisite. Recommended preparation: KIN 166. Grade Option)

Reviews basic volleyball skills and begins work on more advanced skills and playing strategies.

KIN 166B BEGINNING/INTERMEDIATE VOLLEYBALL

Units: 1.0 CSU | 48-54 hours laboratory

(No prerequisite. Recommended preparation: KIN 166. Grade Option)

Reviews basic volleyball skills and begins work on more advanced skills and playing strategies.

KIN 166C INTERMEDIATE/ADVANCED VOLLEYBALL

Units: 1.0 CSU | 48-54 hours laboratory

(No prerequisite. Recommended preparation: KIN 166. Grade Option)

This course is designed to introduce advanced techniques of volleyball skills. Individual skill work, along with various team offensive systems and team defensive patterns, will be taught and analyzed.

KIN 168 INTRODUCTION TO SELF DEFENSE

Units: 1.0 CSU, UC | 48-54 hours laboratory

(No prerequisite. Grade Option) (UC credit limitation)

Introduction to basic self-defense. Defensive strategies to protect oneself from attack.

KIN 176 ATHLETIC TRAINING III

Units: 2.0-6.0 CSU, UC | 96-108 hours laboratory per unit

(Prerequisite: KIN/PE 141 or ALDH 141, or equivalent.)

In this course, students will provide the pre-participation, on-site first aid and event maintenance for fall/winter/spring sports programs at VVC (baseball, basketball, football, golf, soccer, softball, tennis, volleyball, track/field and wrestling). Experience will include, but is not limited to, prophylactic taping and padding, immediate first aid, monitoring vital signs, completion of accident forms, proper use of universal biohazard precautions, supervision of safe playing conditions and coaching techniques, recognition of medical emergencies, assisting other medical personnel as needed, game preparation and pre-participation medical screenings. See cross listing for ALDH 176.

KIN 177 ATHLETIC TRAINING IV

Units: 2.0-6.0 CSU, UC | 96-108 hours laboratory per unit

Prerequisite: KIN/PE 141 or ALDH 141, or equivalent.)

In this course, students will provide the care to athletes involved in fall/winter/spring sports programs at VVC (baseball, basketball, football, golf, soccer, softball, tennis, volleyball, track/field and wrestling). Experience will include but is not limited to development and implementation of rehabilitation protocols. Use of modalities including, whirlpool, ultrasound, ice, Emergency Medical Services, hydrocolator packs, Range of Motion exercises, joint mobilization, strengthening exercises (isokinetic, isotonic, isometric), cardiovascular conditioning and proprioceptive exercises. See cross listing for ALDH 177.

KIN 180A TENNIS

Units: 1.0 CSU | 48-54 hours laboratory

(No prerequisite. Grade Option)

The course offers logical sequences of learning experiences that include: basic tennis strokes; rules that govern play; understanding of game strategies; individual practice drills, and learning the equipment and safety involved.

KIN 180B TENNIS DOUBLES

Units: 1.0 CSU | 48-54 hours laboratory

(No prerequisite. Grade Option)

Students are instructed in the basic skills of doubles for the sport of tennis. Rules of play, strategies, and skill development for doubles are emphasized.

KIN 181 INTRODUCTION TO GOLF

Units: 1.0 **CSU, UC** | 48-54 hours laboratory

(No prerequisite. Grade Option) (UC credit limitation)

Covers the introduction of the use and skill development of equipment including woods, irons and putters. Includes the reading of greens, distance and selection of clubs, etiquette and rules of golf.

KIN185 FOOTBALL TECHNIQUES AND CONDITIONING

Units: 2.0 **CSU** | 96-108 hours laboratory

(No prerequisite. Grade Option)

Course will include drills and exercises to develop the skills, techniques, and conditioning essential for participation in intercollegiate football.

KIN185B OFFENSIVE FOOTBALL TECHNIQUES AND CONDITIONING

Units: 1.0 **CSU** | 48-54 hours laboratory

(No prerequisite. Grade Option)

Through football field activities, this course will provide students an opportunity to learn correct offensive football techniques, flexibility, injury prevention through proper warm-up and football skills. Applicable skill development will be the primary goal of this course. Other areas such as movement skills, knowledge of body movement, self-image, and personal and social growth will also be promoted.

KIN 185C DEFENSIVE FOOTBALL TECHNIQUES

Units: 0.5-1.0 **CSU, UC** | 24-27 - 48-54 hours laboratory

(No prerequisite. Grade Option)

Through football field activities, this course will provide students an opportunity to learn correct defensive football techniques, flexibility, injury prevention through proper warm-up and football skills. Although applicable skill development will be the primary goal of this course; other areas such as movement skills, knowledge of body movement, self-image, and personal and social growth will be promoted.

KIN 186A INTRODUCTION TO AQUA AEROBICS

Units: 1.0 **CSU** | 48-54 hours laboratory

(No prerequisite. Grade Option)

Aqua aerobics is designed to improve cardiovascular endurance, muscular strength/endurance, and flexibility, without the negative effects of gravity, aerobic activities, calisthenics, and stretching movements are set to music and performed in a swimming pool. Students do not have to be able to swim.

KIN 186B AQUA JOGGING

Units: 1.0 **CSU, UC** | 48-54 hours laboratory

(No prerequisite. Grade Option)

A conditioning program in the deep water of a pool with a variety of low impact movements centered on jogging. A buoyancy belt will be used. Students do not need to swim but should be comfortable in deep water.

KIN 188A INTRODUCTION TO INDOOR CYCLING (SPIN)

Units: 1.0 **CSU, UC** | 48-54 hours laboratory

(No prerequisite. Grade Option)

Use of an indoor cycling bike for improving overall physical fitness and health. Course focuses on endurance, strength, intervals, high intensity and recovery.

KIN 201 INTRODUCTION TO EXERCISE PHYSIOLOGY

Units: 3.0 **CSU** | 48-54 hours laboratory

(No prerequisite. Recommended preparation: BIOL 211 and BIOL 231)

The study of human physiological processes during exercise and activity. Includes study of metabolic changes to main body systems during acute exercise, the physiological adaptations due to chronic exercise and the effect of gaining upon performance.

Kinesiology Courses

KIN 210 MOVEMENT ANATOMY

Units: 3.0 **CSU** | 48-54 hours lecture

(Prerequisites: BIOL 211 or BIOL 215)

Exploration of the muscular-skeletal system and its function during human movement. Study movement and the muscles involved during sport skill performance.

Kinesiology-Dance Courses

KIND 160A TAP DANCE IA (Formerly PEDA 160)

Units: 1.0 **CSU** | 48-54 hours laboratory

(No prerequisite. Grade Option)

Students who would like to explore tap dancing for the first time will experience basic tap dancing techniques with the foundational sense of musicality. During this course, many essential elements will be stressed: style, proper counting techniques, rhythm, interpretation of music and basic choreographic elements. See cross listing for TA 160A.

KIND 160B TAP DANCE IB

Units: 1.0 **CSU,UC** | 48-54 hours laboratory

(No prerequisite. Grade Option)

Students who would like to further explore tap dancing after having some tap experience will expand on their basic tap dance techniques with the foundational sense of musicality. During this course, many essential elements will be stressed: style, proper counting techniques, rhythm, interpretation of music and basic choreographic elements. Emphasis will be placed on enhancing musical and rhythmic phrasing and performance clarity in movement combinations. See cross listing for TA 160B.

KIND 160C TAP DANCE IC

Units: 1.0 **CSU,UC** | 48-54 hours laboratory

(No prerequisite. Grade Option)

Students who would like to further explore tap dancing after having some tap experience and preparing for Tap IIA will expand on their tap dance techniques with the foundational sense of musicality. During this course, many essential elements will be stressed: style, proper counting techniques, rhythm, interpretation of music and basic choreographic elements. Emphasis will be placed on enhancing musical and rhythmic phrasing and performance clarity in complex movement combinations, and the refinement of performance style. See cross listing for TA 160C.

KIND 161A TAP DANCE IIA (Formerly PEDA 161)

Units: 1.0 **CSU,UC** | 48-54 hours laboratory

(No prerequisite. Grade Option)

Students who would like to explore tap dancing at an intermediate level for the first time after having had some tap dance will experience intermediate tap dancing techniques with the foundational sense of musicality. During this course, many essential elements will be stressed: style, proper counting techniques, rhythm, interpretation of music and basic choreographic elements. See cross listing for TA 161A.

KIND 161B TAP DANCE IIB

Units: 1.0 **CSU,UC** | 48-54 hours laboratory

(No prerequisite. Grade Option)

Students who would like to further explore tap dance at an intermediate level after having had some tap dance will experience intermediate tap dance techniques with a fundamental sense of musicality. During this intermediate course a number of elements will be stressed: style, proper counting techniques, rhythm, interpretation of music and basic choreographic elements. Emphasis will be placed on enhancing musical and rhythmic phrasing, efficient alignment, and performance clarity in movement combinations. See cross listing for TA 161B.

Kinesiology-Dance Courses

KIND 161C TAP DANCE IIC

Units: 1.0 **CSU,UC** | 48-54 hours laboratory

(No prerequisite. Grade Option)

Students who would like to further explore tap dance at an intermediate level, working towards Tap III, after having some tap dance will experience intermediate tap dance techniques with a fundamental sense of musicality. During this course a number of elements will be stressed: style, proper counting techniques, rhythm, interpretation of music and basic choreographic elements. Emphasis is placed on enhancing musical and rhythmic phrasing, efficient alignment, performance clarity in complex movement combinations, and the refinement of performance style. See cross listing for TA 161C.

KIND 162A INTRODUCTION TO BALLROOM DANCE

Units: 1.0 **CSU,UC** | 48-54 hours laboratory

(No prerequisite. Grade Option)

Introduction to Ballroom Dance encompasses dance techniques, styles and rhythms of beginning level ballroom dance, both traditional and Latin dances will be included. Emphasis is on exploring the movement characteristics of the dances.

KIND 162B AMERICAN RHYTHM BALLROOM DANCE

Units: 1.0 **CSU,UC** | 48-54 hours laboratory

(No prerequisite. Grade Option)

Techniques and stylization in the following ballroom dances. Dances may include the Swing, Mambo, Bolero, Cha Cha, and Rumba.

KIND 163A LATIN BALLROOM DANCE

Units: 1.0 **CSU** | 48-54 hours laboratory

(No prerequisite. Grade Option)

Techniques, styles and rhythms of the basic level of Latin ballroom dance. May include at least the following dances: Samba, Cha Cha, Rumba, Paso Doble, Jive and Tango.

KIND 163B STANDARD BALLROOM DANCE

Units: 1.0 **CSU,UC** | 48-54 hours laboratory

(No prerequisite. Grade Option)

Techniques and stylization in the following ballroom dance. Dances may include the Waltz, Tango, Foxtrot, Quickstep, Viennese Waltz.

KIND 166A INTRODUCTION TO BALLET DANCE IA

Units: 1.0 **CSU,UC** | 48-54 hours laboratory

(No prerequisite. Grade Option)

Student with no previous training or experience in ballet will explore introductory level ballet technique, style, and movement characteristics through dancing. See cross listing for TA 166A.

KIND 166B BUILDING BALLET BASICS IB

Units: 1.0 **CSU,UC** | 48-54 hours laboratory

(No prerequisite. Grade Option)

Students with introductory level ballet training will build and expand basic ballet technique, style, and movement characteristics. See cross listing for TA 166B.

KIND 166C BALLET FUNDAMENTALS IC

Units: 1.0 **CSU,UC** | 48-54 hours laboratory

(No prerequisite. Grade Option)

Students who have previous training in introductory Ballet IA and Building Ballet Basics IB will further explore and perfect their training in ballet fundamentals. See cross listing for TA 166C.

Kinesiology-Dance Courses

KIND 167A INTRODUCTION TO INTERMEDIATE BALLET IIA

Units: 1.0 [CSU,UC](#) 48-54 hours laboratory

(No prerequisite. Grade Option)

An introduction to the technique and style of beginning intermediate level Ballet IIA dance. This course is for the student who has taken Ballet I level courses. Emphasis on exploring the movement characteristics of beginning intermediate level Ballet IIA dance through dancing. See cross listing for TA 167A.

KIND 167B INTERMEDIATE BALLET DANCE IIB

Units: 1.0 [CSU,UC](#) 48-54 hours laboratory

(No prerequisite. Grade Option)

Students who have been introduced to intermediate Ballet IIA will build and explore intermediate ballet IIB skills and concepts. See cross listing for TA 167B.

KIND 167C INTERMEDIATE BALLET IIC

Units: 1.0 [CSU,UC](#) 48-54 hours laboratory

(No prerequisite. Grade Option)

Students who have training in Intermediate Ballet IIA and Intermediate Ballet IIB will explore and build advanced intermediate ballet skills. See cross listing for TA 167C.

KIND 169A INTRODUCTION TO YOGALATES

Units: 1.0 [CSU](#) 48-54 hours laboratory

(No prerequisite. Grade Option)

Yogalates is an introduction of Pilates concepts developed by Joseph Pilates. The course will introduce core mat work and yoga-type exercises. It will also introduce improved body alignment, strength, flexibility and control.

KIND 169B BASIC YOGALATES

Units: 1.0 [CSU](#) 48-54 hours laboratory

(No prerequisite. Grade Option)

Basic Yogalates is a class encompassing Pilate's concepts developed by Joseph Pilates and Yoga. The course will introduce basic core mat work and yoga-type exercises. It will also introduce improved body alignment, strength, flexibility and control.

KIND 169C YOGALATES CORE STABILITY AND STRETCH

Units: 1.0 [CSU,UC](#) 48-54 hours laboratory

(No prerequisite. Grade Option)

Yogalates Core Stability and Stretch introduces physical conditioning techniques focusing on core muscle strengthening, balance, coordination and flexibility through Pilates mat work and basic yoga exercises. This class uses exercise ball, yoga mat, hand weights to strengthen the core, improve balance, coordination and flexibility.

KIND 169D YOGALATES CORE STABILITY AND STRETCH II

Units: 1.0 [CSU,UC](#) 48-54 hours laboratory

(No prerequisite. Grade Option)

Yogalates Core Stability and Stretch II is a physical conditioning class that focuses on an intermediate level core muscle strengthening, balance, coordination and flexibility. This class uses intermediate level Pilates mat work and yoga exercises and enhances posture, body awareness and muscular conditioning. This class also uses exercise ball, yoga mat, and hand weights.

KIND 170A JAZZ DANCE 1A

Units: 1.0 [CSU,UC](#) 48-54 hours laboratory

(No prerequisite. Grade Option)

Students who would like to explore jazz dance for the first time will experience basic jazz dance techniques with a fundamental sense of musicality. During this beginning course a number of elements will be stressed: style, proper counting techniques, rhythm, interpretation of music and basic choreographic elements. See cross listing for TA 170A.

Kinesiology-Dance Courses

KIND 170B JAZZ DANCE 1B

Units: 1.0 **CSU,UC** | 48-54 hours laboratory

(No prerequisite. Grade Option)

Students who would like to further explore jazz dance after having some jazz dance experience will expand on their basic jazz dance techniques and fundamental sense of musicality. During this course a number of elements will be stressed: style, proper counting techniques, rhythm, interpretation of music and basic choreographic elements. Emphasis will be placed on enhancing musical and rhythmic phrasing, efficient alignment, and performance clarity in movement combinations. Other styles such as theater jazz may be incorporated. See cross listing for TA 170B.

KIND 170C JAZZ DANCE 1C

Units: 1.0 **CSU,UC** | 48-54 hours laboratory

(No prerequisite. Grade Option)

Students who would like to further explore jazz dance after having some jazz dance experience, will expand on their jazz dance techniques and fundamental sense of musicality. During this course a number of elements will be stressed: style, proper counting techniques, rhythm, interpretation of music and basic choreographic elements. Emphasis is placed on enhancing musical and rhythmic phrasing, efficient alignment, performance clarity in complex movement combinations, and the refinement of performance style. See cross listing for TA 170C.

KIND 171A JAZZ DANCE IIA

Units: 1.0 **CSU,UC** | 48-54 hours laboratory

(No prerequisite. Grade Option)

Students who would like to explore jazz dance at an intermediate level for the first time after having had some jazz dance will experience intermediate jazz dance techniques with a fundamental sense of musicality. During this intermediate course a number of elements will be stressed: style, proper counting techniques, rhythm, interpretation of music and basic choreographic elements. See cross listing for TA 171A.

KIND 171B JAZZ DANCE IIB

Units: 1.0 **CSU,UC** | 48-54 hours laboratory

(No prerequisite. Grade Option)

Students who would like to further explore jazz dance at an intermediate level after having had some jazz dance will experience intermediate jazz dance techniques with a fundamental sense of musicality. During this intermediate course a number of elements will be stressed: style, proper counting techniques, rhythm, interpretation of music and basic choreographic elements. Emphasis will be placed on enhancing musical and rhythmic phrasing, efficient alignment, and performance clarity in movement combinations. See cross listing for TA 171B.

KIND 171C JAZZ DANCE IIC

Units: 1.0 **CSU,UC** | 48-54 hours laboratory

(No prerequisite. Grade Option)

Students who would like to further explore jazz dance at an intermediate level, working towards Jazz III, after having some jazz dance will experience intermediate jazz dance techniques with a fundamental sense of musicality. During this course a number of elements will be stressed: style, proper counting techniques, rhythm, interpretation of music and basic choreographic elements. Emphasis is placed on enhancing musical and rhythmic phrasing, efficient alignment, performance clarity in complex movement combinations, and the refinement of performance style. See cross listing for TA 171C.

KIND 174A INTRODUCTION TO MODERN DANCE

Units: 1.0 **CSU** | 48-54 hours laboratory

(No prerequisite. Grade Option)

Introduction to technique and stylization of modern dance. For the student who has never had modern dance or who is new to the beginning level of modern dance. Emphasis on exploring the movement characteristics of introductory level modern dance through dancing. See cross listing for TA 174A.

Kinesiology-Dance Courses

KIND 174B BASIC MODERN DANCE I

Units: 1.0 CSU | 48-54 hours laboratory

(No prerequisite. Grade Option)

Basic technique and stylization of modern dance. For the student who has never had modern dance or who is new to the beginning level of modern dance. Emphasis on exploring the movement characteristics of introductory level modern dance through dancing. See cross listing for TA 174B.

KIND 174C BEGINNING MODERN DANCE I

Units: 1.0 CSU,UC | 48-54 hours laboratory

(No prerequisite. Grade Option)

Beginning level technique and stylization of modern dance. For the student who has never had modern dance or who is new to the beginning level of modern dance. Emphasis on exploring the movement characteristics of beginning level modern dance through dancing. See cross listing for TA 174C.

KIND 174D INTERMEDIATE MODERN DANCE I

Units: 1.0 CSU,UC | 48-54 hours laboratory

(No prerequisite. Grade Option)

Level I technique and stylization of modern dance. For the student who has had introduction to Modern Dance, Basic Modern Dance I, Beginning Modern Dance I or who is new to modern dance. Emphasis on exploring the movement characteristics of level I modern dance through dancing. See cross listing for TA 174D.

KIND 175A INTRODUCTION TO MODERN DANCE II

Units: 1.0 CSU,UC | 48-54 hours laboratory

(No prerequisite. Grade Option)

Technique and stylization of introductory level modern dance II. This course is for the student who has taken Modern Dance I level classes. Emphasis on exploring the movement characteristics of introductory level modern dance II through dancing. See cross listing for TA 175A.

KIND 175B BASIC MODERN DANCE II

Units: 1.0 CSU,UC | 48-54 hours laboratory

(No prerequisite. Grade Option)

Technique and stylization of basic modern dance II. This course is for the student who has taken Modern Dance I level classes and/or Introduction to Modern Dance II. Emphasis on exploring the movement characteristics of basic level modern dance II focusing on improving Modern II level technique. See cross listing for TA 175B.

KIND 175C MODERN DANCE II

Units: 1.0 CSU | 48-54 hours laboratory

(No prerequisite. Grade Option)

Technique and stylization of Modern Dance level II. This course is for the student who has taken Modern Dance I and Basic Modern Dance II levels of dance. Students will prepare their bodies as an instrument for dance.

KIND 175D INTERMEDIATE MODERN DANCE II

Units: 1.0 CSU | 48-54 hours laboratory

(No prerequisite. Grade Option)

Technique and stylization of Intermediate Modern Dance II. This course is for the student who has taken Modern Dance I, Basic Modern Dance II levels with the emphasis of the class on exploring Intermediate Modern Dance II level movement technique by progressing to longer, faster-paced, more difficult modern dance movement phrases.

KIND 176A INTRODUCTION TO DANCE REHEARSAL AND PERFORMANCE I

Units: 1.0-3.0 CSU | 48-54 hours laboratory per unit

(No prerequisite. Grade Option)

This course is designed to introduce students to the methods used for introductory level I dance rehearsal and performance. This class is for the student who has never taken dance performance before but has taken some form of dance technique. Students will learn the etiquette of introductory level I dance rehearsal and performance, develop skills needed for quick pick up in dance choreography, and performance skills needed for dance production purposes.

Kinesiology-Dance Courses

KIND 176B PERFORMANCE DANCE ENSEMBLE

Units: 1.0-3.0 **CSU** | 48-54 hours laboratory per unit

(No prerequisite. Grade Option)

This course is designed to introduce students to the methods used for dance performance and to provide students with an opportunity for public dance performance onstage.

KIND 176C DANCE PRODUCTION

Units: 1.0-3.0 **CSU,UC** | 48-54 hours laboratory per unit

(No prerequisite. Grade Option)

This course is specifically designed for the student to learn and perform dance choreography of multiple dance disciplines. It includes learning, rehearsing and performing one or more choreographed dance pieces.

KIND 176D DANCE PERFORMANCE

Units: 1.0-3.0 **CSU** | 48-54 hours laboratory per unit

(No prerequisite. Grade Option)

This course is designed to provide students with the opportunity for intensive preparation for public performance of choreographed works.

KIND 180 INTRODUCTION TO CLASSICAL MUSICAL THEATRE DANCE

Units: 1.0 **CSU,UC** | 48-54 hours laboratory

(No prerequisite. Grade Option)

This course is an in-depth performance experience focusing on styles of body movement indicative of Classical Musical Theatre stage productions (1943 – 1965). The fundamentals of Classical musical theatre dance will be introduced, including Classical Broadway jazz and tap style genres. Concepts of the history of dance in Classical musical theatre will also be introduced. See cross listing for TA 180.

KIND 181 INTRODUCTION TO CONTEMPORARY MUSICAL THEATRE DANCE

Units: 1.0 **CSU** | 48-54 hours laboratory

(No prerequisite. Grade Option)

This course is an in-depth performance experience focusing on styles of body movement indicative of Contemporary Musical Theatre stage productions (1966 – Present). The fundamentals of Contemporary musical theatre dance will be introduced, including Contemporary Broadway jazz and tap style genres. Concepts of the history of dance in Contemporary musical theatre dance will also be introduced. See cross listing for TA 181.

KIND 182 BEGINNING CLASSICAL MUSICAL THEATRE DANCE

Units: 1.0 **CSU,UC** | 48-54 hours laboratory

(No prerequisite. Grade Option)

Technique and style of beginning Classical theatre dance (1943 - 1965) will be explored. This course is an in-depth performance experience focusing on styles of body movement for Classical Musical Theatre stage productions. The fundamentals of Broadway style dance will be reviewed, including basic Classical jazz and tap. Classical Musical theatre dance genres will be introduced by category, including more sophisticated character stylization of Classical musical staging. Concepts of the history of classical musical theatre dance will be further explored. See cross listing for TA 182.

KIND 183 BEGINNING CONTEMPORARY MUSICAL THEATRE DANCE

Units: 1.0 **CSU,UC** | 48-54 hours laboratory

(No prerequisite. Grade Option)

Technique and style of beginning Contemporary theatre dance (1966 - Present) will be explored. This course is an in-depth performance experience focusing on styles of body movement for Contemporary Musical Theatre stage productions. The fundamentals of Contemporary Broadway style dance will be reviewed, including basic Contemporary jazz and tap. Contemporary Musical theatre dance genres will be introduced by category, including more sophisticated character stylizations of Contemporary musical staging. Concepts of the history of Contemporary musical theatre dance will be further explored. See cross listing for TA 183.

KIND 186A INTRODUCTION TO HIP HOP DANCE

Units: 1.0 **CSU, UC** | 48-54 hours laboratory

(No prerequisite. Grade Option)

Basic techniques and styles of Hip Hop dance both historical and current emphasizing musicality, rhythms, basic and complex movements required to develop performance and choreographic skills, and critical viewing and analysis of Hip Hop dance choreography.

Law

There is no single “prelaw” major. Research has revealed that success in law school is based more on one’s ability to grasp and solve difficult intellectual problems and to employ disciplined work habits. In choosing a major, one should choose a course of study that will give broad cultural background and include intensive research. Most law students major in Business Administration, Economics, English, Liberal Studies, History, Philosophy, Political Science, or Sociology, although law schools accept any major.

Most American Bar Association (ABA) accredited law schools require a bachelor’s degree and certain scores on the Law School Admission Test (LSAT) for entrance into an intensive three-year program. Students who complete law school earn the Juris Doctor (J.D.) degree and can practice law in the state of California upon passage of the California bar exam. Some law schools require only an associate degree for admission and often require completion of a four-year program.

The following sampling of ABA-accredited law schools in California require a bachelor’s degree and a high score on the LSAT:

- Pepperdine University
- Stanford University
- University of California Berkeley, Davis, Los Angeles
- University of La Verne
- University of Southern California

Liberal Arts Major

Associate in Arts Degree

The Associate degree in Liberal Arts (04975) is designed for students who wish to have a broad knowledge of the liberal arts and sciences plus additional coursework in an Area of Emphasis. Within this major, students who plan on transferring to a university can typically satisfy both their general education requirements as well as many pre-major requirements for transfer. Consult with a counselor for information regarding your intended major and the specific college or university of your choice. Visit www.assist.org for more information.

Requirements:

- **Complete the VVC General Education pattern and all other graduation requirements**
- **Choose an Area Of Emphasis:**
Complete a minimum of 18 units from ONE of these three areas of emphasis below.

Mathematics/Science Emphasis (18594)

These courses emphasize the natural sciences which examine the physical universe, its life forms and its natural phenomena. Courses in Math emphasize the development of mathematical and quantitative reasoning skills beyond the level of intermediate algebra. Students will be able to demonstrate an understanding of the methodologies of science as investigative tools. Students will also examine the influence that the acquisition of scientific knowledge has on the development of the world's civilization.

Complete at least 18 units from the following, with at least one course in math AND one in science, with at least TWO courses in any ONE subject.

AGNR 123, 170; ANTH 101, 101L; ASTR 101; BIOL 100, 107, 118, 201, 202, 203, 210, 211, 214, 221, 231; CHEM 100, 201, 202, 206, 207, 281, 282; GEOG 101, 101L, 130; GEOL 101; MATH 104, 105/H105, 116, 120/H120, 132, 226/H226, 227/H227, 228/H228, 231, 270; OCEA 101; PSCI 101; PHYS 100, 201, 202, 203, 204, 221, 222; PSYC 109

Arts and Humanities Emphasis (18595)

These courses emphasize the study of cultural, literary, and humanistic activities and artistic expression. Students will evaluate and interpret the ways in which people through the ages in different cultures have responded to themselves and to the world around them in artistic and cultural creation. Students will also learn to value aesthetic understanding and incorporate these concepts when constructing value judgments.

Complete at least 18 units from the following, with at least TWO courses in any ONE subject.

ANTH 106; ART 101, 102, 104, 105, 106, 107, 108, 109, 112, 113, 114, 120, 122, 125, 150; CART 133; CMST 105 (Intercultural); ENGL 102/102H, 109, 116*, 220, 225, 230, 231, 232, 234, 235, 240, 241, 245, 246, 247; HIST 103, 104, 115, 117/H117, 118/H118, 130, 131, 155, 157; KIN 103 (History of Dance); MUSC 100, 101, 102, 103, 116, 117, 118, 131, 202, 204; PHIL 101, 108, 114*, 117*, 120, 121; POLS 114*; RLST 101, 105, 106, 110, 111, 115, 117*; TA 101, 102, 104, 107, 110, 116*

Languages: ASL 122, 123, 124, 125; FREN 101, 102, 103, 104; SPAN 101, 101A, 101B, 102, 103, 104

Social/Behavioral Science Emphasis (18596)

These courses emphasize the perspectives, concepts, theories and methodologies of the social and behavioral sciences. Students will learn about themselves and others as members of a larger society. Topics and discussion to stimulate critical thinking about ways people have acted in response to their societies will allow students to evaluate how societies and social subgroups operate.

Complete at least 18 units from the following, with at least TWO courses in any ONE subject

AGNR 175, 178; AJ 101; ANTH 101, 102, 103, 105, 106; CHDV 100, 106; CMST 105 (Intercultural); ECON 101, 102; GEOG 101, 102, 103, 104; GUID 101, 105, 107; HIST 103, 104, 115, 117/H117, 118/H118, 130, 131, 155, 157; KIN 104; PHIL 114*; POLS 101, 102/H102, 103, 104, 110, 112, 113, 114*, 206, 211; PSYC 101, 110, 111, 121, 125, 133, 204, 213; RLST 113, 115; SOC 101, 102, 103, 107

Liberal Arts Major

Note: All courses shown transfer to CSU: courses in bold transfer to both CSU and UC

*Cross-listed courses are the same course listed under different departments
ENGL 116 = TA 116; PHIL 114 = POLS 114; PHIL 117 = RLST 117

Underlined courses fulfill the VVC Global Citizenship competency.

Thinking of Transferring to a University

How Transfer Works

Generally, if you start at a community college, where you complete your lower division general education (GE) and any required pre-major preparation, you can then transfer to a university as a junior, with an associate's degree in hand - and about half of your bachelor's degree already completed.

Universities You Could Transfer To

California has two public university systems: the University of California (UC) and the California State University (CSU). There are many private universities as well – not to mention all the schools that are out-of-state. How do you choose where to apply? It takes some research, and there are many sources that can help you.

VVC's Transfer Center – www.vvc.edu/offices/transfer-center/ - 760 245-4271, x 2139

Your most important resource is the VVC Transfer Center, located in Building 55, over the lake. In it you will find lots of information about universities, and you can make an appointment to see a transfer counselor as well as representatives of several universities that visit us regularly. You'll also find catalogs from campuses all over the state and many from out-of-state as well.

For more information about transferring, visit these websites:

- www.assist.org – The ASSIST site helps you explore majors at all 33 UC and CSU campuses. We have formal, course-to-course equivalency agreements with many of the UC and CSU campuses, and ASSIST shows you VVC courses required for various majors.
- www.californiacolleges.edu/ - CaliforniaColleges.edu covers UC, CSU and independent colleges, and provides virtual campus tours, student-campus matching assistance, information on financial aid, and admissions planners for first-year and transfer students.
- uctransfer.universityofcalifornia.edu - This site explains what you'll need to do to transfer and how you can make smart course choices now that will maximize your chances of being admitted to UC.
- www.universityofcalifornia.edu – The University of California, Office of the President, offers this site for information about UC. It also provides links to each of the ten UC campuses.
- www.calstate.edu – Provides information about California State University's educational programs, systemwide policies and initiatives, historical and general information, admission requirements and procedures. Here you'll also find links to all 23 CSU campuses.
- www.aiccu.edu – This is the official website of the Association of Independent California Colleges and Universities. Visit this site for information on independent (non-UC or CSU) schools.

Bachelor's Degrees in the High Desert

And don't forget – there are some well-regarded private universities that offer bachelors and other programs right here in the High Desert. Ask in the Transfer Center for the "Local Bachelor's Degree Opportunities" sheet, also available on the college's website. You can meet with their representatives in the Transfer Center to learn about your options and requirements.

Be Careful of Unaccredited Schools

There are many outfits that purport to run a college or university – typically but not exclusively online. Don't be fooled if they tell you they are "accredited." The question to ask is, WHO accredits them? You want an institution that is *regionally* (not nationally) accredited. See a counselor for more details.

Degrees and Certificates Awarded

Associate in Science, Math/Science

Associate Degree

To earn an Associate in Science degree with a major in Math/Science, complete a minimum of 18 units from any of the following courses in addition to all other VVC general education and graduation requirements:

MATHEMATICS

ELCT 57, 58, 59, 60

MATH 104, 105/H105, 116, 120/H120, 129, 132, 226/H226, 227/H227, 228/H228, 231, 270

PSYC 215

LIFE SCIENCES

ANTH 101, 101L

BIOL 100, 107, 110, 118,201, 202, 203, 210, 211, 213, 215, 221, 231, 233

HLTH 102

PHYSICAL SCIENCES

AGNR 123, 170

ASTR 101

CHEM 100,128, 201, 202, 206, 207, 281, 282

GEOG 101, 101L, 103, 130

GEOL 101, 128, 129

OCEA 101

PSCI 101, 128

PHYS 100, 128, 129, 201, 202, 203, 204, 221, 222

RMGT 120

Transfer

The Associate in Science degree in Math/Science is often a degree earned by students who are pursuing a bachelor's degree in transfer majors such as Biology, Chemistry, Engineering, Environmental Studies, Geology, Mathematics, and Physics. To explore a bachelor's degree in these fields, visit www.assist.org. Please stop by the Transfer Center in Building 55 or make an appointment with a counselor if you have questions.

Mathematics

Mathematics is a rapidly expanding, dynamic discipline which has contributed to recent advances in astronomy, biology, chemistry, engineering, medicine and physics. Mathematics is truly becoming the necessary language of a wide spectrum of knowledge.

The mathematics program is designed to accept students at many levels of mathematical maturity and enable them to gain the mathematical knowledge necessary for them to achieve their goals.

Career Opportunities

An undergraduate degree in mathematics can lead to a variety of jobs in business, industry, government, and teaching. Mathematicians are employed by companies in communication, computers, energy and finance.

Faculty

Bob Carlson | Nichole Carver | Joe Estephan | Patrick Malone
Pat Mauch | Arda Melkonian | Said Ngobi | Jeff Redona | Jeff Ridge
Mary Lynn Stough | Stephen Toner | Anh Weis

Degrees and Certificates Awarded

Associate in Science for Transfer, Mathematics

Associate Degree

To earn an Associate in Science degree for Transfer with a major in Mathematics, complete the required major courses and all other requirements specified on the following pages (i.e. 60 CSU transferable units, CSU GE or IGETC, etc.). For more information on the AA-T/AS-T degrees, meet with a counselor or www.adegreewithaguarantee.com

Transfer

To pursue a bachelor's degree in this field, here are some schools that have programs that might interest you. For the most up-to-date information on these programs and others, visit www.assist.org. Please stop by the Transfer Center in Building 55 or make an appointment with a counselor if you have questions.

- **California State University, San Bernardino:** Mathematics major
- **University of California, Riverside:** Mathematics major

Program Learning Outcomes

A student receiving a degree or certificate in this field will be able to:

- Calculate arithmetic, algebraic, geometric, spatial, and statistical quantities using appropriate technology.
- Estimate arithmetic, algebraic, geometric, spatial, and statistical solutions.
- Solve arithmetic, algebraic, geometric, spatial, and statistical expressions, equations, functions, and problems using appropriate technology.
- Represent mathematical information numerically, symbolically, graphically, verbally, and visually using appropriate technology.
- Interpret mathematical and statistical models such as formulas, functions, graphs, tables, and schematics, drawing conclusions and making inferences based on those models.
- Develop mathematical and statistical models such as formulas, functions, graphs, tables, and schematics using appropriate technology.
- Communicate mathematical theories and ideas clearly and concisely to others in the oral and written form.

MATHEMATICS, AS-T (31025)		
<p>The role of mathematics is vital and growing, providing solutions to problems in a wide range of sciences: social, biological, physical, behavioral, and management. As a whole, mathematics is necessary for understanding and expressing ideas in science, engineering, and human affairs. Mathematics is integrally related to computer science and statistics, which have proven invaluable to advancing research and modern industrial technology. The Mathematics curriculum academically prepares the student to transfer to a 4-year university to complete a Baccalaureate degree in a similar major.</p> <p>The major requirements for the AS-T degree align with the intersegmental Transfer Model Curriculum (TMC) for Mathematics. Students should consult with a counselor to determine whether this degree is the best option for their transfer goals.</p>		
Program Requirements: 19 units		
Required Courses (15 units total)		
MATH 226/226H	Analytic Geometry and Calculus I	4.0
MATH 227/227H	Analytic Geometry and Calculus II	4.0
MATH 228/228H	Analytic Geometry and Calculus	5.0
Additional Courses		
List A – (3 units total)		
MATH 270	Differential Equations	3.0
List B – (3 units total)		
MATH 231	Linear Algebra	3.0
<p>A student wishing to pursue an AA-T/AS-T degree in the major listed on this page must ensure the CSU of their choice is accepting that similar major. Students completing an AA-T/AS-T degree are guaranteed admissions into a CSU campus given that a student fulfills the following:</p> <ol style="list-style-type: none"> 1) 60 CSU transferable units; 2) Completes the CSU General Education (GE) or IGETC General Education pattern; 3) Completes the major requirements for the AA-T/AS-T; 4) Maintains a transferable cumulative GPA of at least 2.0 (C or better); 5) Completes the basic/Golden 4 GE requirements. <p>For more information on the AA-T/AS-T degrees, meet with a counselor or visit www.adegreewithaguarantee.com</p>		

Mathematics Courses

MATH 6 MATH OPERATIONS

Units: 1.0

16-18 hours lecture

(No prerequisite.) This course does not apply to the Associate Degree.

This math course will review computations (addition, subtraction, multiplication, division) with whole numbers. The course also introduces students to operations with rational numbers and decimals.

MATH 10 BASIC MATH SKILLS

Units: 3.0

48-54 hours lecture

(No prerequisite.) This course does not apply to the Associate Degree.

This course covers the basic operations applied to whole numbers, fractions (including mixed numbers) and decimals. Prime factorization, least common multiple, ratio and proportion, similar triangles, averages; graphs and tables, square roots, the Pythagorean theorem, measurement, operations on signed-numbers and solutions of simple linear equations are also covered.

MATH 12 PRE-ALGEBRA

Units: 3.0

48-54 hours lecture

(Prerequisite: Eligibility as determined by VVC assessment.) This course does not apply to the Associate Degree.

This course reviews fractions, decimals and integers with a strong emphasis on solving equations and problem solving in order to prepare students for Introductory Algebra. Ratios and proportions are also covered, as well as an introduction to graphing linear equations, working with polynomials, and factoring.

MATH 42 ELEMENTARY ALGEBRA

Units: 4.0

64-72 hours lecture

(Prerequisite: MATH 12 minimum grade C, or eligibility as determined by VVC assessment. Corequisite: MATH 42S) This course does not apply to the Associate Degree.

To be taken with MATH 42S. This course covers a review of arithmetic operations with whole, decimal, fractional and signed numbers, exponential notations, percentages, and order of operations. Algebraic expressions, solving and graphing linear equations and inequalities, polynomial operations and polynomial factoring, rational and radical expressions and equations, quadratic equations and solutions to quadratic equations are also covered.

MATH 42S ELEMENTARY ALGEBRA WITH SKILLS SUPPORT

Units: 5.0

80-90 hours lecture

Prerequisite: MATH 12 with a Grade of "C" or better or eligibility as determined by VVC assessment) This course does not apply to the Associate Degree

This course covers a review of arithmetic operations with whole, decimal, fractional and signed numbers, exponential notation, percentages, and order of operations. Algebraic expressions, solving and graphing linear equations and inequalities, polynomial operations and polynomial factoring, rational and radical expressions and equations, quadratic equations and solutions to quadratic equations are also covered. This course does not apply to the Associate Degree. This class focuses on study skills and extra support for students by teaching some concepts using different learning modalities.

MATH 63 PRE-STATISTICS MATHEMATICS

Units: 5.0

80-90 hours lecture

(Prerequisite: MATH 12 OR MATH 42 with a grade of 'C' or better, or eligibility as determined by VVC assessment.)

This non-STEM course covers core algebra skills needed to understand the concepts, formulas, and graphs used in transfer-level statistics. Integrates numeracy, proportional reasoning, algebraic reasoning, and functions. Develops conceptual and procedural tools that support the use of key mathematical concepts in a variety of contexts. Throughout the course, college success content will be integrated with mathematical topics. This course is NOT intended for math, science, computer science, business, or engineering majors.

MATH 90 INTERMEDIATE ALGEBRA

Units: 4.0 | 64-72 hours lecture

(Prerequisite: MATH 42 (formerly MATH 50 or both MATH 50A and MATH 50B), MATH 42-S or MATH 63 with a grade of 'C' or better or eligibility as determined by VVC assessment.)

This course is designed to serve as a preparation for the study of College Algebra, Statistics, Trigonometry and other college mathematics courses. Topics include a review of the real number system, an introduction to imaginary and complex numbers, the solution of first degree, quadratic and systems of equations, polynomials, rational expressions, exponents and radicals, graphs of functions (both linear and nonlinear) and of relations, and exponential and logarithmic functions.

MATH 90S INTERMEDIATE ALGEBRA WITH SKILLS SUPPORT

Units: 5.0 | 64-72 hours lecture

(Prerequisite: MATH 42, MATH 42S, or MATH 63 with a grade of "C" or better or eligibility as determined by VVC assessment.)

This course is designed to serve as a preparation for the study of College Algebra and Trigonometry and other college mathematics courses. Topics include a review of the real number system, an introduction to imaginary and complex numbers, the solution of first degree, quadratic and systems of equations, polynomials, rational expressions, exponents and radicals, graphs of functions (both linear and nonlinear) and of relations, and exponential and logarithmic functions. This class also focuses on study skills and extra support for students by teaching some concepts using different learning modalities.

MATH 104 TRIGONOMETRY

Units: 4.0 | [CSU](#) | 64-72 hours lecture

(Prerequisite: MATH 90 or MATH 90S with a grade of 'C' or better.)

Topics for this preparatory course for calculus include trigonometric functions and equations, solutions of both right and oblique triangles, trigonometric forms of complex numbers and De Moivre's Theorem. Course content also includes verification of trigonometric identities, inverse trigonometric functions, half and multiple angles, vectors and their applications, parametric equations, polar coordinates and polar equations.

MATH 105 COLLEGE ALGEBRA

Units: 4.0 | [CSU, UC](#) | 64-72 hours lecture

(Prerequisite: MATH 90 or MATH 90S with a grade of 'C' or better or eligibility as determined by VVC assessment.) (UC credit limitation)

The course offers a review of real numbers, real number exponents, and factoring polynomials. The course also covers equations and inequalities, solutions to systems of equations and inequalities, solutions to equations and inequalities involving absolute value, graphing relations and functions, matrices, determinants of matrices, and matrix algebra. Complex numbers, the real and complex zeros of polynomials, the zeros of exponential, rational and radical functions, the conic sections, sequences, mathematical induction and the binomial theorem are also covered.

MATH 105H HONORS COLLEGE ALGEBRA

Units: 4.0 | [CSU, UC](#) | 64-72 hours lecture

(Prerequisite: MATH 90 or MATH 90S with a grade of 'C' or better.) (UC credit limitation)

This course covers all the topics of the regular MATH 105 course, but the topics are covered in greater depth. Exponents and radicals, theory of quadratic equations, simultaneous quadratic equations, complex numbers, equations of higher degree, inequalities, logarithmic and exponential equations, binomial theorem, matrices and determinants, partial fractions, sequences and series.

MATH 116 PREPARATION FOR CALCULUS

Units: 3.0 | [CSU, UC](#) | 48-54 hours lecture

(Prerequisite: Math 104 and Math 105 or H105, minimum grade C, or eligibility as determined by the VVC assessment test. Co-requisite: MATH 104 or MATH 105 or MATH 105H.)

Function, theory, techniques for graphing functions (polynomials, rational functions, trig functions, exponential functions, log functions, and compositions of these such as trig polynomials), conic sections, solutions of systems of linear and non-linear equations, inequalities, introduction to limits.

Mathematics Courses

MATH 120 INTRODUCTION TO STATISTICS

Units: 4.0 **CSU, UC** | 64-72 hours lecture

(Prerequisite: MATH 90, MATH 90S or MATH 63 with a grade of 'C' or better, or eligibility as determined by VVC assessment.)

The use of probability techniques, hypothesis testing, and predictive techniques to facilitate decision-making. Topics include descriptive statistics; probability and sampling distributions; statistical inference; correlation and linear regression; analysis of variance, chi-square and t-tests; and application of technology for statistical analysis including the interpretation of the relevance of the statistical findings. Applications using data from disciplines including business, social sciences, psychology, life science, health science, and education.

MATH 120S INTRODUCTION TO STATISTICS

Units: 5.0 **CSU, UC** | 80-90 hours lecture

(Prerequisite: MATH 90, MATH 90S or MATH 63 with a grade of 'C' or better, or eligibility as determined by VVC assessment.)

Prerequisite: Math 90, Math 90-S, or Math 63 with a grade of "C" or better, or eligibility as determined by VVC assessment test. The use of probability techniques, hypothesis testing, and predictive techniques to facilitate decision-making. Topics include descriptive statistics; probability and sampling distributions; statistical inference; correlation and linear regression; analysis of variance, chi-square and t-tests; and application of technology for statistical analysis including the interpretation of the relevance of the statistical findings. Applications using data from disciplines including business, social sciences, psychology, life science, health science, and education. This class also focuses on study skills and extra support for students by teaching some concepts using different learning modalities.

MATH 120H HONORS INTRODUCTION TO STATISTICS

Units: 4.0 **CSU, UC** | 64-72 hours lecture

(Prerequisite: MATH 90, MATH 63 or MATH 66 with a grade of 'C' or better.)

Basic statistical techniques, design and analysis for both parametric and non-parametric data are included. Descriptive statistics are included. Graphing techniques of illustrating the data are covered. Probability is covered. Inferential statistics included are estimation and hypothesis testing, chi-square, analysis of variance, and regression. Applications are drawn from a variety of fields. In addition, the Honors component will include the design of surveys, probability testing, and a research project.

MATH 129 INDEPENDENT STUDY

Units: 1-3 units **CSU** |

See Independent Study listing

MATH 129AH INDEPENDENT STUDY HONORS - FIRST SEMESTER

Units: 1.0 **CSU** | 54 hours independent study

(No prerequisite)

Independent study provides individual students challenging and in-depth study on approved topics within any subject area. Independent study proposals must have the approval of the instructor and appropriate administrator. It is expected that the study will not duplicate existing curriculum; rather, it will be of an advanced nature and extend approved courses or series of courses. This first semester honors independent study course is intended to begin the study of advanced topics at an honors level.

MATH 129BH INDEPENDENT STUDY HONORS - SECOND SEMESTER

Units: 1.0 **CSU** | 54 hours independent study

(Prerequisite: MATH 129AH)

Independent study provides individual students challenging and in-depth study on approved topics within any subject area. Independent study proposals must have the approval of the instructor and appropriate administrator. It is expected that the study will not duplicate existing curriculum; rather, it will be of an advanced nature and extend approved courses or series of courses. This second semester honors independent study course is intended to provide students who have completed a first semester of independent study with the opportunity to deepen their understanding of their chosen advanced topic of mathematics at an honors level.

MATH 129CH INDEPENDENT STUDY HONORS - THIRD SEMESTER

Units: 1.0 **CSU** | 54 hours independent study

(Prerequisite: MATH 129BH)

Independent study provides individual students challenging and in-depth study on approved topics within any subject area. Independent study proposals must have the approval of the instructor and appropriate administrator. It is expected that the study will not duplicate existing curriculum; rather, it will be of an advanced nature and extend approved courses or series of courses. This third semester honors independent study course is intended to provide students who have completed two semesters of independent study with the opportunity to further deepen their understanding of their chosen advanced topic of mathematics at an honors level with the goal of public presentation or publication.

MATH 132 THE IDEAS OF MATH

Units: 3.0 **CSU, UC** | 48-54 hours lecture

(Prerequisite: MATH 90 or MATH 90S with a grade of 'C' or better or eligibility as determined by VVC assessment.)

Sets and their application to permutations, combinations, binomial theorem, correspondence, countability, finite probability measures, and expectation; linear, exponential and geometric modeling with applications.

MATH 138 COOPERATIVE EDUCATION

Units: 1-8 units **CSU** |

See Cooperative Education listing

MATH 226 ANALYTIC GEOMETRY AND CALCULUS

Units: 4.0 **CSU, UC** | 64-72 hours lecture

(Prerequisites: MATH 104 and MATH 105 or MATH 105H with a grade of C or better, or placement by VVC assessment.)

This class offers an introduction to the calculus of single variables. Topics covered include limits, using limits of functions to determine continuity, finding derivatives and integrals of functions, basic properties of derivatives and integrals, the relationship between derivatives and integrals as given by the Fundamental Theorem of Calculus, and applications.

MATH 226H HONORS ANALYTIC GEOMETRY AND CALCULUS

Units: 4.0 **CSU, UC** | 64-72 hours lecture

(Prerequisite: MATH 104 and MATH 105 or MATH 105H with a grade of C or better, or placement by VVC assessment.) (UC Credit Limitation)

As an introduction to the calculus of single variables, students will develop the concept of limit; apply limits to functions to determine if they are continuous; find the derivative and determine integrals. Students will study the properties of the derivative and integral, their relationship to each other given by the Fundamental Theorem of Calculus. In addition, the honors component will include reading proofs, and writing simple proofs.

MATH 227 ANALYTIC GEOMETRY AND CALCULUS II

Units: 4.0 **CSU, UC** | 64-72 hours lecture

(Prerequisite: MATH 226 or MATH 226H with a grade of 'C' or better.)

This second course in differential and integral calculus of a single variable: integration; techniques of integration; infinite sequences and series; polar and parametric equations; applications of integration.

MATH 227H HONORS ANALYTIC GEOMETRY AND CALCULUS II

Units: 4.0 **CSU, UC** | 64-72 hours lecture

(Prerequisite: MATH 226 or MATH 226H with a grade of 'C' or better.) (UC credit limitation)

The second course in differential and integral calculus of a single variable: integration; techniques of integration; infinite sequences and series; polar and parametric equations; applications of integration. In addition, the honors component will include reading proofs, writing complete proofs from sketches of proofs and applying techniques learned to real-life problems.

Mathematics Courses

MATH 228 ANALYTIC GEOMETRY AND CALCULUS

Units: 5.0 **CSU, UC** | 80-90 hours lecture

(Prerequisite: MATH 227 or MATH 227H with a grade of 'C' or better.)

This course covers vectors and the geometry of space, vector-valued functions, the calculus of functions as several variables, multiple integration, Green's Theorem, divergence theorem, Stoke's Theorem and applications.

MATH 228H HONORS ANALYTIC GEOMETRY AND CALCULUS

Units: 5.0 **CSU, UC** | 80-90 hours lecture

(Prerequisite: MATH 227 or MATH 227H with a grade of "C" or better.)

Vectors and the geometry of space, vector-valued functions, the calculus of functions of several variables, multiple integration, Green's Theorem, divergence theorem, Stoke's Theorem, and applications. In addition, the honors component will include reading proofs, writing complete proofs from sketches of proofs and apply techniques learned to real-life problems.

MATH 231 LINEAR ALGEBRA

Units: 3.0 **CSU, UC** | 48-54 hours lecture

(Prerequisite: MATH 226 or MATH 226H with a grade of 'C' or better or concurrent enrollment in MATH 226.)

An introduction to linear algebra that compliments advanced courses in calculus. Topics include systems of linear equations, matrix operations, determinants, vectors and vector spaces, eigenvalues and eigenvectors and linear transformations. With orthogonality, inner product spaces and numerical methods if time permits.

MATH 270 DIFFERENTIAL EQUATIONS

Units: 3.0 **CSU, UC** | 48-54 hours lecture

(Prerequisite: MATH 227 or MATH 227H with a grade of 'C' or better)

This course covers elementary differential equations, solutions of first order equations, linear equations with constant coefficients, simultaneous linear systems, series solutions, the Laplace transform, and applications to physics and engineering.

Digital Animation has become one of the fastest growing careers within the computer graphics industry. Victor Valley College's Media Arts (MERT) courses are designed for individuals seeking training in advanced techniques and procedures currently used in today's 3D production workplace. Designed for both beginning and advanced students, the department's 3D animation program curriculum is geared toward individuals interested in creating video games, television commercials, product or architectural visualizations, animated logos, 3D website motion graphics or film-based special effects. Learning essential principles and techniques for creating professional quality work, students are introduced to problem-solving situations similar to those encountered in a real world production environment. Students successfully completing the program's courses possess entry-level skills that apply to a wide variety of career opportunities (see below). Several program certificates are currently offered. The primary software package used in all 3D Animation courses in the Media Arts Department is Autodesk Maya.

3D Animation classes are also offered through the college's Computer Integrated and Design (CIDG) Department. Please see the CIDG section of the catalog for the courses the department currently offers.

Career Opportunities

3D Animation Careers: Modeler, Texture Artist/Painter, Lighting Specialist, Character Designer, Character Animator, Special F/X Animator, Environment Designer, Game Level Designer, Architectural Animator, Mechanical Design Animator, Medical Visualization Artist, Courtroom Visualization Artist, Web Graphics Animator, Storyboard Artist, Layout Artist, Graphic Designer, Composer

CAD Careers: Architect, Architectural Drafter, CAD Management, CAD Operator, Cabinet Shop Detailer, Civil Drafter, Computer Animator, Community College Instructor, Construction Technician, Desk-Top Publisher, Electrical Drafter, Electronics Drafter, GIS Technician, Graphics Designer, Interior Designer, Landscape Architect, Landscape Designer, Mapping Specialist, Mechanical Drafter, Public Works Technician, Rendering Specialist, Steel Fabricator Drafter, Structural Drafter, Technical Illustrator

Degrees and Certificates Awarded

Digital Animation Technician I – Maya	Digital Animation Artist – Maya
Expanded Animation Technician – Maya	Digital Filmmaker
Digital Animation Technician I – 3ds Max	see Computer Integrated and Design Dept (CIDG)
Digital Animation Artist – 3ds Max	see Computer Integrated and Design Dept (CIDG)
Expanded Animation Technician – 3ds Max	see Computer Integrated and Design Dept (CIDG)

Note: Associate of Science Degree programs require completion of at least 60 units of credit, which normally will take 4 semesters. Certificate programs, many of which lead to an Associate of Science degree, vary in the number of units required. Most can be completed in 2 - 4 semesters. Each course required for a certificate must be completed with a "C" grade or better. All can be counted toward its related degree.

Transfer

To pursue a bachelor's degree in this field, here are some schools that have programs that might interest you. For the most up-to-date information on these programs and others, visit www.assist.org, or, for private schools, www.aiccu.edu. Please stop by the Transfer Center in Building 55 or make an appointment with a counselor if you have questions.

UC campuses offering Animation include Berkeley and UCLA

CSU campuses that offer Animation include Long Beach, Chico, Fullerton, Los Angeles, and San Jose

Private schools include University of Southern California (USC), Biola University, Loyola Marymount University, Chapman University and Academy of Arts San Francisco

Program Learning Outcomes

For Cad & Drafting

- To create compelling two and three dimensional project that meet current industry standards
- To discuss the key components of design, process, layout, and function as it relates to the real work

For Animation

- To discuss the key components of design, process, layout, and function as it relates to the real world
- To develop scene aesthetics that emphasizes creativity and storytelling

For more animation classes see Computer Integrated Design & Graphics (CIDG)

Media Arts

DIGITAL ANIMATION TECHNICIAN I MAYA CERTIFICATE OF CAREER PREPARATION

The Maya certificate is designed to offer students a detailed look at one of the Animation industry's premiere 3D packages. Students will study a variety of topics, including how to model 3D objects, creation of a realistic material, the art of camera and lighting techniques, and an introduction to advanced keyframing. In addition to completing several animation projects, students learn about both the history of Animation and the traditional principles involved in making an individual's work look both realistic and believable.

Units Required: 9.0

All of the following must be completed with a grade of "C" or better:

MERT 50	Principles of Animation in Maya	3.0
MERT 51	Advanced Materials, Lighting and Rendering with Maya	3.0
MERT 52	Digital Character Animation with Maya	3.0

DIGITAL ANIMATION ARTIST MAYA CERTIFICATE OF CAREER PREPARATION

The Digital Animation Artist - Maya certificate is designed to expand an individual's expertise in 3D Animation by requiring additional training in traditional art principles and techniques. Employers many times view an animator who possesses the ability to both draw and more thoroughly understand concepts and practices specific to traditional art painting as more well-rounded and work-ready. By earning the Digital Animation Artist certificate, students will better position themselves for employment opportunities in this fast-paced and competitive field. An Adobe Photoshop course specific to 3D Animation applications is also required to earn a certificate.

Units Required: 15.0

Complete the requirements listed in both Group I and Group II

All of the following must be completed with a grade of "C" or better:

MERT 50	Principles of Animation in Maya	3.0
MERT 51	Advanced Materials, Lighting and Rendering with Maya	3.0
MERT 52	Digital Character Animation with Maya	3.0
MERT 56	Photoshop for Animators	3.0

GROUP II – One of the following must be completed with a grade of "C" or better:

ART 101	Survey of Art History	3.0
ART 104	Film as an Art Form	3.0
ART 112	Design I	3.0
ART 113	Design II	3.0
ART 122	Life Drawing I	3.0
ART 124	Anatomy of Life Drawing	3.0
ART 125	Drawing I	3.0
ART 141	Sculpture I	3.0

EXPANDED ANIMATION TECHNICIAN MAYA CERTIFICATE OF CAREER PREPARATION

This certificate crosses over all the software taught under the MERT program, any student who achieves this certificate has gone through the program and successfully completed the demo reel project, they have learned to work in a large complex environment and complete assigned tasks on an individual and group level. The student has learned the functions required to work on a large structured project in which their skill sets in a CG environment are tested and judged by peers in the class and the instructor when the project is finalized.

Units Required: 12.0

All of the following must be completed with a grade of "C" or better:

MERT 50	Principles of Animation in Maya	3.0
MERT 51	Advanced Materials, Lighting and Rendering with Maya	3.0
MERT 52	Digital Character Animation With Maya	3.0
MERT 53	Advanced Animation/Demo Reels	3.0

DIGITAL FILMMAKER CERTIFICATE OF CAREER PREPARATION

The Digital Filmmaker certificate is designed to teach students to look at films as an art form, rather than as entertainment. The courses taken to complete the certificate provide students invites to explore the expressive and communicative nature of film while also examining the process by which films are made. The courses cover topics such as camera operation, lighting, composition, script-writing, storyboarding, audio, editing, compositing, and practical film making techniques. Individual projects will give students the opportunity to hone their personal skill set, while large group and class projects will teach students to work collaboratively, a necessary skill in this demanding industry.

Units Required: 6.0

All of the following must be completed with a grade of "C" or better:

ART 104	Film as an Art Form	3.0
MERT 74	Digital Video Production	3.0

DIGITAL ANIMATION TECHNICIAN I 3DS MAX CERTIFICATE OF CAREER PREPARATION

The 3ds Max certificate is designed to offer students a detailed look at one of the Animation industry's premiere 3D packages. The courses taken to complete the certificate provide students an opportunity to learn a variety of topics, including how to model 3D objects, how to create realistic textures and materials, the art of camera and lighting techniques, and a variety of keyframing solutions to bring their ideas to life. In addition to completing both individual and group projects, students also delve into the traditional principles of animation that serve to heighten the level of realism and believability of an individual's work.

Units Required: 9.0

All of the following must be completed with a grade of "C" or better:

CIDG 160	3ds Max Fundamentals	3.0
CIDG 260	3ds Max Adv Modeling and Materials	3.0
CIDG 261	3ds Max Character Animation and Advanced Keyframing Techniques	3.0

DIGITAL ANIMATION ARTIST 3DS MAX CERTIFICATE OF CAREER PREPARATION

The Digital Animation Artist certificate is designed to expand an individual's expertise in 3D Animation by requiring additional training in traditional art principles and techniques. Employers many times view an animator who possesses the ability to both draw and more thoroughly understand concepts and practices specific to traditional art painting as more well-rounded and work-ready. By earning the Digital Animation Artist certificate, students will better position themselves for employment opportunities in this fast-paced and competitive field. An Adobe Photoshop course specific to 3D Animation applications is also required to earn a certificate.

Units Required: 15.0

Complete the requirements listed in both Group I and Group II

GROUP I - All of the following must be completed with a grade of "C" or better:

CIDG 160	3ds Max Fundamentals	3.0
CIDG 260	3ds Max Adv Modeling and Materials	3.0
CIDG 261	3ds Max Character Animation and Advanced Keyframing Techniques	3.0
MERT 56	Photoshop for Animators	3.0

GROUP II - One of the following must be completed with a grade of "C" or better:

ART 101	Survey of Art History	3.0
ART 104	Film as an Art Form	3.0
ART 112	Design I	3.0
ART 113	Design II	3.0
ART 122	Life Drawing I	3.0
ART 124	Anatomy of Life Drawing	3.0
ART 125	Drawing I	3.0
ART 141	Sculpture I	3.0

Media Arts

EXPANDED ANIMATION TECHNICIAN 3DS MAX CERTIFICATE OF CAREER PREPARATION

This certificate crosses over all the software taught under the CIDG and MERT programs, any student who achieves this certificate has gone through the program and successfully completed the demo reel project, they have learned to work in a large complex environment and complete assigned tasks on an individual and group level. The student has learned the functions required to work on a large structured project in which their skill sets in a CG environment are tested and judged by peers in the class and the Instructor when the project is finalized.

Units Required: 12.0

All of the following must be completed with a grade of "C" or better:

CIDG 160	3ds Max Fundamentals	3.0
CIDG 260	3ds Max Advanced Modeling and Materials	3.0
CIDG 261	3ds Max Character Animation and Advanced Keyframing Techniques	3.0
MERT 53	Advanced Animation/Demo Reels	3.0

Media Arts Courses

MERT 50 PRINCIPLES OF ANIMATION IN MAYA

Units: 3.0

32-36 hours lecture and 48-54 hours laboratory

(No prerequisite. Grade Option)

Students will learn the basics of 3D modeling in Maya, how to create and apply realistic textures, lighting principles and techniques, camera types and their appropriate usage, and fundamental keyframing procedures. Other topics to be covered include storyboards, the traditional principles of animation, current industry trends and issues pertaining to rendering output for different mediums (film, video, Internet, etc.)

MERT 51 ADVANCED MATERIALS, LIGHTING AND RENDERING WITH MAYA

Units: 3.0

32-36 hours lecture and 48-54 hours laboratory

(Recommended Preparation: MERT 50. Grade Option)

This course covers advanced material techniques using Hypershade, rendering with Mental Ray and advanced lighting techniques. Students will complete a combination of exercises, individual and group projects.

MERT 52 DIGITAL CHARACTER ANIMATION WITH MAYA

Units: 3.0

32-36 hours lecture and 48-54 hours laboratory

(Recommended Preparation: MERT 50, MERT 51, or familiarity with a current 3D application, preferably Maya. Grade Option)

This course is an advanced study in digital character animation and feature-length digital media production. This course explores the relationships between anatomy, motion, weight, and timing through a balanced combination of exercises, individual and group projects.

MERT 53 ADVANCED ANIMATION/ DEMO REELS

Units: 3.0

32-36 hours lecture and 48-54 hours laboratory

(Prerequisite: MERT 50 or CIDG 160. Grade Option)

This course is an in depth look at creating an animation production with a final reel being the goal of the class. The course covers camera techniques, staging, modeling, texturing, character development, story development, plot development, storyboarding, titling, and final production using industry standards as guidelines from start to finish.

MERT 56 PHOTOSHOP FOR ANIMATORS

Units: 3.0

32-36 hours lecture and 48-54 hours laboratory

(Recommended Preparation: CIDG 160 or MERT 50. Grade Option)

Students will learn the concepts and procedures required for creating high quality texture maps and imagery for use in 3D computer animation. Topics will include basic and advanced editing techniques, managing tone and color, layer management, optimization strategies and the use of filters. Compositing techniques will be addressed in detail. Relevant issues dealing with the pre-production process, and industry trends and analysis will also be discussed.

MERT 74 DIGITAL VIDEO PRODUCTION

Units: 3.0

32-36 hours lecture and 48-54 hours laboratory

(Recommended preparation: ART 133, CIS 101. Grade Option)

This course introduces digital video production techniques. Course topics include the operation of digital camcorders, lighting, sound equipment and post production digital editing suites, and the principles and aesthetics of film and video editing.

MERT 80 ZBRUSH FUNDAMENTALS

Units: 3.0

32-36 hours lecture and 48-54 hours laboratory

(Recommended preparation: MERT 50, CIDG 160. Grade Option)

Students will learn the concepts and procedures required for creating high quality texture maps and Zbrush models for use in 3D computer animation. Topics will include basic and advanced editing techniques with Hard Surface modeling, ZSpheres, detailing models with various brushes and masks, layer management and optimization strategies for high resolution models. Relevant issues dealing with ZBrush models and other 3D packages and industry trends and analysis will also be discussed. Grade Option.

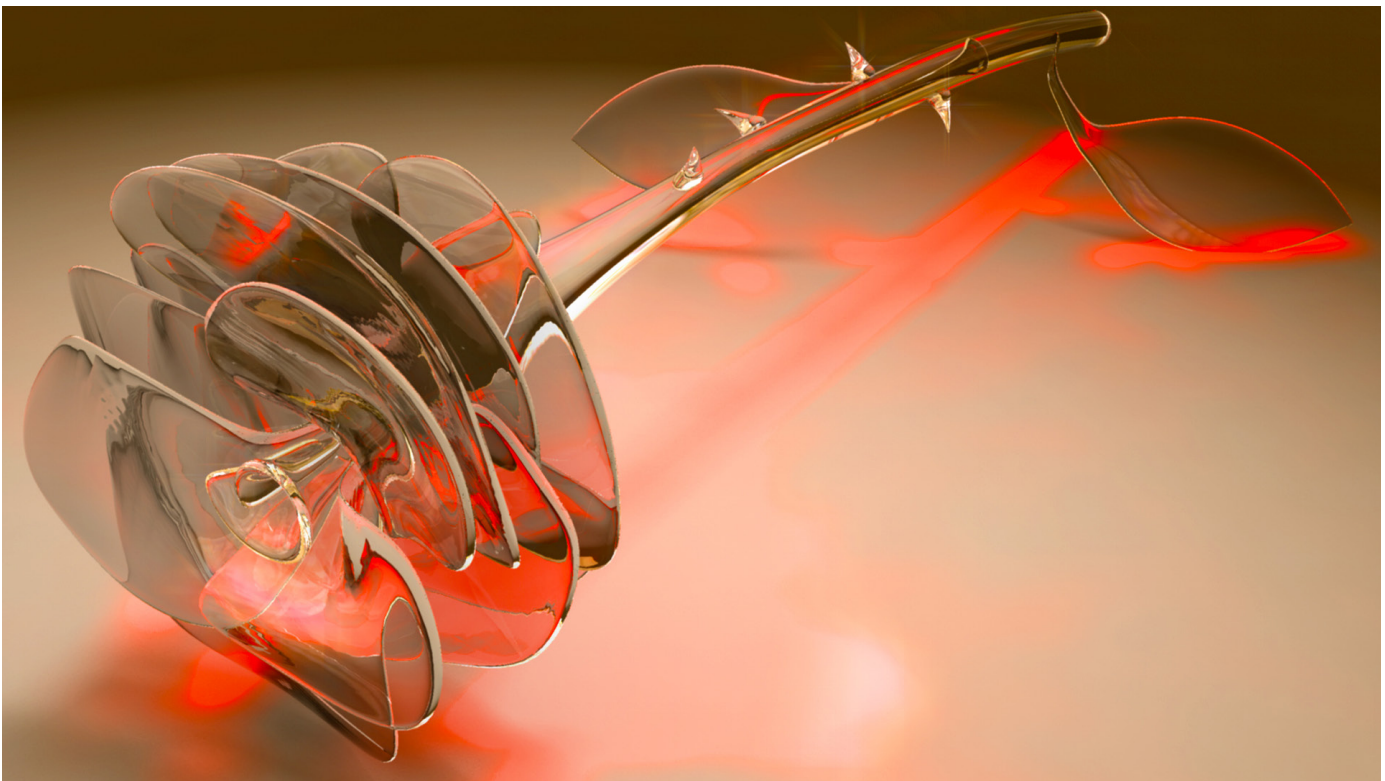

Medical and Health Professions

The programs of study in the following medical and health professions are not offered at Victor Valley College, but preparatory courses needed for transfer into these majors are offered as outlined below.

Athletic Training

Athletic training is a growing profession that involves evaluation, management, and rehabilitation of athletic injuries. It is also the organization and administration of athletic training programs, as well as the education and counseling of the athlete. This program of study was recently endorsed by the American Medical Association as an allied health profession.

Athletic Training programs may also be offered as an option under Kinesiology, Exercise Science, or Physical Education majors at most universities. The average GPA for students enrolling in these programs is a 3.0 GPA or better.

Common lower division courses students should complete prior to transferring to a university as an Athletic Training, Kinesiology, Exercise Science, or Physical Education major:

BIOL 211, 231; CHEM 201; PHYS 221; MATH 120; PSYC 101

For more information on athletic training or kinesiology programs, visit: www.assist.org or meet with a counselor.

Pre-Chiropractic (D.C.)

Chiropractic Medicine places the emphasis on spinal manipulation and neuromuscular treatments as the means of restoration and preservation of health. Chiropractors diagnose health problems, provide care and consult with other health care providers. Prior to enrolling, applicants must have completed a minimum of 90 semester units, applicable to a bachelor's degree, with a minimum cumulative GPA of a 2.5 on a 4.0 scale.

Common lower division course requirements for chiropractic medicine:

BIOL 201, 202; CHEM 201, 202, 281, 282; PHYS 221, 222; ENGL 101, 102 or 104; PSYC 101

Highly recommended courses: BIOL 221, 231; PHYS 201; CMST 109; MATH 105

15 additional semester units from Social Sciences and/or Humanities

The following four schools are the only California colleges accredited by American Chiropractic Association:

Cleveland Chiropractic College, Los Angeles

www.clevelandchiropractic.edu

Life Chiropractic College-West, Hayward

www.lifewest.edu

Southern California University of Health Sciences

www.scuhs.edu (formerly: Los Angeles College of Chiropractic)

Palmer College of Chiropractic, San Jose

www.palmer.edu

For more information on chiropractic colleges, visit: www.chiropractic.org

Dental Hygiene (R.D.H.)

Dental hygienists provide educational and clinical services for patients, including dental health education and disease prevention procedures, obtaining and recording patients' medical and dental histories, scaling and polishing teeth, recording conditions of patients' mouths and teeth, exposing and processing dental x-ray films, nutritional counseling, and applying fluoride and pit and fissure sealants for prevention of decay. Dental Hygiene is a rapidly growing profession and is emerging as a vital, highly respected component of dental health.

Before admission into the Dental Hygiene program students must have graduated from an accredited secondary school, have a minimum of 60 semester units of transferable course work, rate sufficiently high on the Dental Hygiene Aptitude Test (DHAT), and complete prerequisite coursework with a cumulative GPA of 3.0 or better.

There are multiple California community colleges that offer an Associate of Science or Arts degree in Dental Hygiene. For more information on accredited Dental Hygiene community college programs, visit: www.cdha.org/.

Common lower division course requirements for most Dental Hygiene programs:

BIOL 201, 211, 221, 231; CHEM 100, 201, 202; ENGL 101, 102 or 104; PSY 101; SOC 101; CMST 109

Other courses recommended to complete 60 required units: CHEM 120, 281; MATH 120.

The following four California universities offer a bachelor's degree in Dental Hygiene and are accredited by the Commission on Dental Accreditation (CODA):

Loma Linda University	www.llu.edu/dentistry/admissions/index.page
University of Southern California	dentistry.usc.edu/education.aspx
University of the Pacific	www.pacific.edu/
West Coast University	www.westcoastuniversity.edu/
West L.A. College	www.wlac.edu

A handout with all transfer requirements for a B.S. degree in Dental Hygiene from Loma Linda University is available in Counseling or can be obtained from the website above.

For more information on Dental Hygiene programs, visit: www.adha.org

Health Care Management, Health Information Management

Health Care Managers are involved with policy formulation, finance, administrative functions, roles of medical staff, federal and state regulation, planning and marketing, human resources and other health care management functions. Positions are typically found In hospitals, clinics, managed care organizations, long-term care facilities, and medical offices. Management and staff opportunities for graduates in this field Include consulting firms, durable medical equipment companies, pharmaceutical companies, and health care Information systems vendors.

Health Information Managers provide leadership in managing medical information systems that serve patients, health care providers, and administrative staff. It is an excellent career choice for the person who is seeking a health care profession that combines interests in computer science, business, management, legal procedures, and research. This unique background provides the health information administrator with a wide variety of employment opportunities. These include positions in acute care, outpatient care, long-term care, mental health facilities, insurance companies, governmental agencies, legal offices, and with computer system vendors.

The health information manager will have opportunities to develop health information systems for quality patient care, financial reimbursement, medical research, health care planning, and security of patient information. Many health information managers also have responsibilities that Include planning organizing the medical records department, budgeting department resources, determining department policies and procedures, and evaluating and motivating employees. Because information is vital to quality patient care, the health information manager interacts daily with medical, financial, and administrative staff.

Recommended preparation for Health Care Management and Health Information Management programs varies greatly from school to school, but may include: BADM 101 or BADM 103; BADM 102 or BADM 104; ECON 102; BIOL 211; BIOL 221; CHEM 100; PSYC 101; and many more, depending on the institution.

For UC and CSU campuses that have these majors, please visit www.assist.org for more Information about specific requirements by campus.

For Loma Linda University, please visit www.llu.edu and search under Allied Health Professions.

Pre-Dentistry (DDS/DMD)

Dentists provide comprehensive dental treatment to patients including oral and maxillofacial surgery, endodontics, orthodontics, and restorative processes.

Because most of the applicants being admitted to dental schools possess a bachelor's degree, students are advised to integrate the dental school requirements into a program that will lead to a bachelor's degree in a major of their choice. While many successful applicants major in one of the natural sciences, a science major is NOT required for admission to medical school. There are Dental Schools which consider 90 semester units (60 units lower division and 30 units of upper division coursework) with a very competitive grade point average (GPA). The average GPA for accepted students to U.S. dental schools is a 3.5. In addition a score sufficiently high on the Dental Admission Test (DAT) (www.adea.org) is required along with course prerequisites. Extracurricular activities (community/campus), research, and clinical experience are highly encouraged to become a competitive applicant.

Common lower division course requirements for dentistry schools:

BIOL 201, 202, 211, 221, 231; CHEM 201, 202, 206+207 or 281+282 (recommended); ENGL 101, 102 or 104; MATH 226; PHYS 221, 222; PSYC 101; CMST 109

11 units in Social Sciences/Humanities/Foreign Language. Courses from the following are highly recommended: Algebra/Calculus/Statistics, Accounting/Economics, Technical Writing, Sociology/Anthropology, Business Management, and Ceramics/Sculpture.

The following six California schools offer a Doctor of Dental Surgery (DDS) and are the only California universities accredited by the Commission on Dental Accreditation (CODA):

Loma Linda University	www.llu.edu/llu/dentistry
University of California, Los Angeles (UCLA)	www.uclasod.dent.ucla.edu/
University of the Pacific	www.dental.pacific.edu/
University of California, San Francisco (UCSF)	www.dentistry/ucsf/edu/
University of Southern California (USC)	www.usc.edu/hsc/dental
Western University of Health Sciences	www.prospective.westernu/dentistry

A handout with all transfer requirements for a D.D.S. degree in Dentistry from Loma Linda University is available in counseling.

For more information on dentistry schools, visit: www.ada.org.

Pre-Medicine (MD) and Pre-Osteopathic Medicine (DO)

Doctors of Medicine manage the diagnosis, treatment, and prevention of disease and injuries of individuals to restore them back to optimal health. Treatment may include surgery, various treatment methods, conferring with other specialists, and prescribing appropriate drugs. Physicians also research the causes, transmission, and control of diseases and other ailments.

Medicine is a highly competitive field and acceptance into medical school is based on a combination of preparatory courses completed, letters of recommendation, sufficiently high scores on the Medical College Admissions Test (MCAT), and GPA. Most students who are admitted into medical school have a bachelor's degree; therefore, a bachelor's degree is highly recommended. Since requirements for medical school places emphasis on biology and chemistry, most students choose to pursue a bachelor's degree in biology or chemistry. While many successful applicants major in one of the natural sciences, a science major is NOT required for admission to medical schools. The average GPA for accepted students to U.S. medical schools is a 3.6. Extracurricular activities (community/campus), research, and clinical experience are highly encouraged to become a competitive applicant.

A handout entitled "Premedical Course Preparation for California Medical School Programs" is available from the VVC Counseling department. Students should also consult school catalogs, websites, and the Medical School Admission Requirements: U.S. and Canada, (MSAR) published by the Association of American Medical Colleges (AAMC) for specific requirements. A copy of the MSAR is available for purchase at www.aamc.org

Common lower division course requirements for most medical schools:

BIOL 201, 202; CHEM 201, 202, 281, 282; ENGL 101, 102 or 104; MATH 226, 227; PHYS 221, 222

Highly recommended courses: CHEM 206, 207; CIS 101; SPAN 101,102; PSYC 101 or SOC 101; CMST 106 or 109

A minimum of 90 semester units, at least 20 of which must be upper division from a four-year university.

The following eight medical schools in California offer a Doctor of Medicine (MD) degree and are accredited by the Liaison Committee on Medical Education (LCME) of the American Medical Association (AMA):

Loma Linda University	www.llu.edu/llu/medicine
Stanford University	www.med.stanford.edu
University of California	
Davis:	www.ucdmc.ucdavis.edu/medschool/
Irvine:	www.med.uci.edu

Los Angeles: www.medstudent.ucla.edu

Riverside: www.medstudent.ucr.edu

San Diego: medicine.ucsd.edu

San Francisco: www.medschool.ucsf.edu

University of Southern California www.usc.edu/schools/medicine

Western University of Health Sciences www.westernu.edu/osteopathic

For more information on medical schools, visit: www.aamc.org

Nursing – see separate section on Nursing

Occupational Therapy (O.T.)

Occupational Therapists (OT) look at the psychological and social concerns, as well as physical factors, to assist physically disabled people relearn and adapt basic motor skills. Occupational Therapists use every day (occupational) activities as a means of helping those people achieve independence, focusing on critical daily tasks ranging from dressing to employment tasks. Most OT programs require the

Graduate Record Examination (GRE) and a minimum cumulative GPA of a 3.0 or better. A minimum of 80 volunteer/experience hours are required with at least 60 hours being under supervision of an Occupational Therapist

Because the entrance requirements, prerequisites, and program components vary from college to college, students should consult school catalogs and websites for specific information about the programs from each college to which they plan to apply.

Common lower division course requirements for most Occupational Therapy programs:

BIOL 201, 202, 211, 231; PSYC 101, 110, 213; MATH 120, ENGL 101, 102, or 104; SOC 101 or ANTH 102; CMST 109, PHYS 221, 222

Additional courses in Humanities/Social Sciences may be required.

The following California schools award a Master's degree in Occupational Therapy:

CSU Dominguez Hills

www.csudh.edu/OT

Loma Linda University

www.llu.edu

San Jose State University

www.sjsu.edu/occupationaltherapy

University of Southern California

ot.usc.edu/admissions/bs-to-ma

Dominican University of California

www.dominican.edu

Samuel Merritt University

www.samuelmerritt.edu

Stanbridge College

www.stanbridge.edu

University of St. Augustine for Health Sciences-California

www.usa.edu

A handout with all transfer requirements for a B.S. degree in Occupational Therapy from Loma Linda University is available in the counseling department.

For more information on Occupational Therapy programs, visit: www.aota.org

Occupational Therapy Assistant (O.T.A.)

Occupational Therapy Assistants (COTA) work under the guidance of occupational therapists to carry out treatment programs for many different kinds of patients. The COTA enjoys a job that uses creative, personal, and technical skills; works with people of all ages with many kinds of health problems; uses specialized job skills developed in classroom and clinical experiences; benefits from a career with excellent employment opportunities; and shares a respected position as an important member of the health care team. All colleges require a minimum GPA of 2.0 or better to apply to their COTA programs. Competitive applicants have cumulative GPAs of 2.5 or better.

Common lower division course requirements for most Occupational Therapy Assistant programs:

BIOL 211, 231; ENGL 101; PSYC 101; CMST 109; MATH 120

The following California Community colleges offer Associate degrees in Occupational Therapy Assistant:

Santa Ana Community College
 Grossmont Community College
 Sacramento City College
 Monterey Peninsula College

www.sac.edu
www.grossmont.edu
www.scc.losrios.edu
www.mpc.edu

Pre-Osteopathic Medicine (D.O.) (also see Medicine)

A Doctor of Osteopathic Medicine (D.O.) diagnoses and treats diseases and injuries of the human body, relying upon accepted medical and surgical modalities. The emphasis of osteopathic medicine is holistic medicine.

While many successful applicants major in one of the natural sciences, a science major is NOT required for admission to osteopathic medical school. Entrance into the intense four-year program is based on a minimum requirement of 90 semester units or 3/4 toward a bachelor's degree, a high score on the Medical College Admissions Test (MCAT), and a high GPA. The average GPA for accepted students to U.S. osteopathic medical schools is a 3.45. Extracurricular activities (community/campus), research, and clinical experience are highly encouraged to become a competitive applicant.

Common lower division course requirements for most osteopathic medical schools:

BIOL 201, 202; CHEM 201, 202, 281, 282; ENGL 101, 102 or 104; PHYS 221, 222; MATH 226, 227

Highly recommended courses: BIOL 221; MATH 120.

Courses in the Social Sciences, Humanities, Languages, and computer skills are also recommended:

PSYC 101 or SOC 101 or ANTH 102; SPAN 101, 102; CIS 101; PHIL 101.

The following California schools offer programs leading to a Doctor of Osteopathic Medicine (D.O.) degree:

Western University of Health Science

www.westernu.edu

Tuoro University College of Osteopathic Medicine California

www.tu.edu/

For more information on osteopathic medical programs, visit: www.aacom.org.

Pre-Pharmacy (Pharm. D.)

A pharmacist compounds and dispenses prescribed medications, drugs, and other pharmaceuticals for patient care, closely following professional standards and state and federal legal requirements.

Admission to schools of pharmacy is highly competitive. Schools of Pharmacy offering the Doctor of Pharmacy generally require the completion of a minimum of 60 semester units of pre-pharmacy coursework. Most students who are admitted into pharmacy schools have a bachelor's degree; therefore, a bachelor's degree is highly recommended. Since requirements for pharmacy school places emphasis on biology and chemistry, most students choose to pursue a bachelor's degree in biology or chemistry. While many successful applicants major in one of the natural sciences, a science major is NOT required for admission to medical school. The average GPA for accepted students to U.S. pharmacy schools ranges from 3.2 to 3.7. Volunteer/work experience in the field of pharmacy is highly encouraged. Two to three letters of recommendation are required by pharmacy schools. California schools do not require the Pharmacy College Admission Test (PCAT), but more than half of out-of-state pharmacy schools do. Chapman University is the only California school that requires the PCAT

Common lower division course requirements for most pharmacy schools:

BIOL 201, 202, 211, 231; CHEM 201, 202, 281, 282; ECON 101 or 102; ENGL 101, 102 or 104; MATH 226, 227; PHYS 221, 222; PSYC 101 or SOC 101 or ANTH 102; CMST 109

Highly recommended courses: BIO 221; CIS 101, Foreign Language.

Depending on the school, additional courses in Humanities/Fine Arts (6-12 units) and Social/Behavioral Sciences (6-12 units) are required.

The following California colleges offer Doctor of Pharmacy (Pharm.D.) degrees:

University of the Pacific

www.pacific.edu/pharmacy

University of Southern California (USC)

www.usc.edu/schools/pharmacy/pharmd/

University of California, San Diego

pharmacy.ucsd.edu/index.shtml

University of California, San Francisco	pharmacy.ucsf.edu
Loma Linda University	www.llu.edu/pharmacy/
Western University of Health Sciences	www.westernu.edu/pharmacy/
Tuoro University	cop.tu.edu
California Northstate College of Pharmacy	pharmacy.cnsu.edu
Chapman University	www.chapman.edu

For more information on schools of pharmacy, visit: www.aacp.org

Pre-Physical Therapy (P.T.)

Physical Therapists evaluate neuromuscular, musculoskeletal, sensory-motor, and related cardiovascular and respiratory functions of the patient. They perform and interpret tests and measurements of these functions and abilities as an aid in the treatment of the patient.

Physical Therapy is a highly competitive program. All accredited entry level physical therapy programs are at the master's level (MS or MPT) or doctorate level (DPT). The DPT is the new educational standard for entry-level work in the field. Most universities offer the Doctorate of Physical Therapy (DPT) degree. Most programs require a student to have at least a 3.0 cumulative and prerequisite GPA, although the average GPA for accepted students may be higher. A bachelor's degree in a related field such as Biology, Kinesiology, and Athletic Training is strongly recommended. In addition, sufficiently high scores on the Graduate Record Examination (GRE), strong letters of recommendation, and paid or volunteer experience in a physical therapy setting are important in the selection process.

Common lower division course requirements for most Physical Therapy programs:

BIOL 201, 202, 211, 231; CHEM 201, 202; ENGL 101, 102 or 104; MATH 120, 226 (Most require MATH 120); PHYS 221, 222; PSYC 101, 110, 213

Highly recommended course: CHEM 281

The following California colleges offer DPT programs accredited by the Commission on Accreditation in Physical Therapy Education (CAPTE):

California State University	
Fresno:	www.fresnostate.edu/chhs/physical-therapy/
Northridge:	www.csun.edu/hhd/pt/
Sacramento:	www.csus.edu/hhs/pt/
Azusa Pacific University	www.apu.edu
Chapman University	www.chapman.edu/CS/pt/
Loma Linda University	www.llu.edu
Mount St. Mary's College	www.msmc.la.edu/
Samuel Merritt University	www.samuelmerritt.edu/physical-therapy
University of California, San Francisco	www.ucsf.edu/
University of the Pacific	www.pacific.edu
University of Southern California (USC)	pt.usc.edu/
Western University of Health Sciences	www.westernu.edu
University of St. Augustine for Health Sciences	www.usa.edu

The following California college offers M.S./MPT programs accredited by the Commission on Accreditation in Physical Therapy Education (CAPTE):

California State University Long Beach:	www.csulb.edu
--	--

A handout with all transfer requirements for a Master of Physical Therapy degree from Loma Linda is available in the Counseling Department.

For more information on physical therapy, visit: www.apta.org.

Physical Therapist Assistant (P.T.A.)

The physical therapist assistant is a skilled technical health worker who, under the supervision of a physical therapist, assists in the patients' treatment program. The extent to which the physical therapist assistant is involved in treatment depends upon the policies of the health facility, the supervising therapist, and the patient. Most colleges require a GPA of 2.5 or better.

Common lower division course requirements for most Physical Therapy Assistant programs:

BIOL 211, 231; ENGL 101; MATH 90

Additional general education and major courses are required. Please check each college's catalog or website for specific course requirements.

The following California colleges offer associate degrees in Physical Therapist Assistant:

Loma Linda University	www.llu.edu/pages/sahp/transfer/documents/vvc.pdf
Cerritos Community College	www.cerritos.edu/pta
San Diego Mesa Community College	www.sdmesa.edu
Sacramento City College	www.scc.losrios.edu
Ohlone Community College	www.ohlone.edu
College of the Sequoias	www.cos.edu

A handout with all transfer requirements for an associate degree from Loma Linda University is available in the VVC Counseling Department.

Pre-Physician Assistant (P.A.)

A physician assistant (PA) is a skilled health care professional who, under the supervision of a physician, performs a variety of medical, diagnostic and therapeutic services. Most physician assistants routinely elicit complete medical histories and perform comprehensive physical examinations. They treat patients with common acute problems such as infections and injuries, perform minor surgical procedures, and provide ongoing care for common chronic problems such as arthritis, hypertension and diabetes.

The usual program requires 24 months to complete. Most PA students earn a bachelor's degree, although an increasing number of PA programs award master's degrees upon completion of the program.

Upon graduation from an accredited PA program, students take an examination given by the National Commission on Certification of Physician Assistants (NCCPA) and achieve national certification by passing the exam. Certified Physician Assistants (PA-C) must be retested every six years. Admission into the PA programs requires a minimum of 60 semester units and most require a GPA of 3.0 or better.

Universities may require completion of the Medical College Admissions Test (MCAT) or the Graduate Record Examination (GRE). Most PA programs will require a minimum of 1000 hours of related direct patient contact.

Common lower division course requirements for most Physician Assistant programs:

BIOL 211, 221, 231; CHEM 100, 201+202 or 281+282; ENGL 101, 102 or 104; MATH 105; PSYC 101; SOC 101 or ANTH 102; 9-12 units from humanities.

Highly recommended courses: BIOL 201, 202; MATH 120; ALDH 139; CIS 101; SPAN 101, 102; CMST 109

The following California universities offer master's programs in Physician Assistant (PA):

Loma Linda University	www.alliedhealth.edu/academics/physician-assistant
Samuel Merritt	amuemerritt.edu/physician-assistant
Stanford University	pcap.stanford.edu/
Tuoro University-California	www.tu.edu
University of California, Davis	www.ucdmc.ucdavis.edu/
University of Southern California	www.usc.edu

Western University of Health Sciences
Marshall B. Ketchum University

prospective.westernu.edu/
www.ketchum.edu

Because the requirements for each program vary slightly, students who are serious about pursuing a career as a physician assistant should consult with the catalog or website of each college/university for which they plan to apply.

For more information on Physician Assistant programs, visit: www.aapa.org

Pre-Podiatry (D.P.M.)

Podiatry is a specialty in medicine and surgery. A podiatrist is concerned with the prevention, diagnosis, and treatment of diseases and disorders which affect the human foot and contiguous structures.

Students must complete a minimum of 60-90 units before transfer with a GPA of 3.0 or better, take the Medical College Admissions Test (MCAT), and meet the following lower division course requirements for transfer.

Lower-division course requirements for California College of Podiatric Medicine, San Francisco Doctor of Podiatric Medicine program.

BIOL 201, 202; CHEM 201, 202, 281, 282; ENGL 101, 102 or 104; PHYS 221, 222, MATH 226

Highly recommended courses: BIOL 206, 211, 221, 231; MATH 227; CMST 109 12 elective units in Humanities/Social Sciences.

The following California universities offer Doctor of Podiatry Medicine (DPM) programs.

Samuel Merritt College
Western University of Health Sciences

www.samuelmerritt.edu/podiatric_medicine
www.western.edu/podiatry/podiatry-about/

For more information on Podiatry programs, visit: calpma.org and www.aacpm.org

Radiologic Technology

The radiologic technologist (x-ray technician) is responsible for the accurate demonstration of body structures on a radiograph or other receptor. The technologist determines proper exposure factors, manipulates medical imaging equipment, evaluates the radiographic quality, and provides for patient protection and comfort.

Most radiologic technology programs are two-year programs with students earning an associate degree upon completion of the program.

Radiologic technologists may choose to train further in the areas of medical sonography, nuclear medicine technology, radiation therapy technology, and special imaging technology.

Entrance requirements vary slightly from college to college. Students should send off for requirements for each college to which they plan to apply. Students are highly encouraged to complete the following courses before transfer into the below college/university:

Chaffey College

www.chaffey.edu

A.S. Radiologic Technology

ALDH 139, BIOL 211, CHEM 100 or PHYS 100, ENGL 101 and MATH 90. Meet with Chaffey College counselor for additional requirements. A cumulative 2.8 GPA or higher is required for application for the program.

Loma Linda University

www.llu.edu

A.S. Medical Radiography

ALDH 139, BIOL 211, BIOL 231, CHEM 100 or PHYS 100, ENGL 101 AND ENGL 102, MATH 90, PSYC 101 or SOC 101, CMST 109, CIS 101 or High School Computer, and Foreign Language. Elective units to complete course requirements may be necessary. Applicants must have a 3.0 cumulative GPA to be considered.

A handout with all transfer requirements for an A.S. degree in Medical Radiography and a B.S. degree in Radiation Technology from Loma Linda University is available in counseling.

For more information on Radiologic Technology, visit: www.asrt.org.

Speech-Language Pathology and Audiology/ Communicative Disorders

Speech-language pathologists are concerned with evaluating and treating children and adults with communication disorders. Difficulties in the areas of speech, language, fluency, and voice are associated with a variety of disorders, including developmental delay, hearing impairment, cleft palate, cerebral palsy, stroke, and head injury. Audiologists are concerned with prevention, identification, assessment, and rehabilitation of hearing disorders. For both professions, it is important that the student have an interest in working with people.

The following California colleges offer bachelor's degrees or master's degrees in Speech Pathology and/or Audiology:

Biola University	www.biola.edu
California State University (several campuses)	www.assist.org
Loma Linda University	www.llu.edu
University of Redlands	www.redlands.edu

Check universities' catalogs or websites for specific course requirements.

Sports Medicine

The field of Sports Medicine deals with understanding the role of science in exercise and health promotion. Programs in Sports Medicine provide a sound knowledge of the scientific principles of maintaining, enhancing, and rehabilitating the body through the medium of exercise and sport.

Only a few universities offer a major in Sports Medicine or even a Sports Medicine option within a physical education or health-related degree. To pursue a bachelor's degree, specific courses should be completed prior to transfer. The average entrance GPA is usually above 3.0.

Common lower division course requirements for most Sports Medicine programs:

BIOL 211, 231; CHEM 201, 202; ENGL 101, 102; MATH 226; PHYS 221, 222, PSYC 101; KIN 101

Complete general education requirements of specific university including social sciences and humanities.

The following California colleges offer a bachelor's or master's degree in Sports Medicine:

Pepperdine University	www.pepperdine.edu
California Lutheran University	www.callutheran.edu
Vanguard University	www.vanguard.edu

Pre-Veterinary Medicine (D.V.M.)

Veterinary medicine is the health profession that deals with the scientific knowledge and decision-making process that culminate in the diagnosis, treatment and prevention of animal diseases. The profession is concerned with enhancing the health, welfare, productivity and utility of animals as well as with the safety of animal products used by people.

Students completing a veterinary medicine program approved by the Board of Examiners in Veterinary Medicine earn a Doctorate of Veterinary Medicine (DVM).

Veterinary medicine is a highly competitive program. Acceptance to this program is based on GPA, scores on the Graduate Record Examination (GRE) or Medical College Admissions Test (MCAT) and any additional examinations, and completion of a minimum of 72 semester units from an accredited college. The average required GPA for U.S. veterinary schools varies by school, from a low 2.5 to a high 3.5. Those who receive offers for admission often have a GPA of 3.5 or better, and have between 500 to 2000 hours of clinical veterinary experience.

As with many specialized medical programs, applicants who have earned a bachelor's degree are highly desirable and more competitive in the admission process. While many successful applicants major in one of the natural sciences, a science major is NOT required for admission to veterinary school.

Common lower division course requirements for most veterinary schools:

BIOL 201, 202, 221; CHEM 201, 202, 206, 281, 282; ENGL 101, 102 or 104; MATH 120; PHYS 221, 222

Highly recommended courses: CHEM 207; PSYC 101; SOC 101 or ANTH 102, 9 units of Humanities courses

The following California Universities offer programs leading to a Doctor of Veterinary Medicine (D.V.M.)

University of California, Davis
Western University of Health Sciences

www.vetmed.ucdavis.edu/studentprograms
www.westernu.edu

For more information on veterinary schools, visit: www.aavmc.org

Important note about programs in the health professions:

In addition to a competitive GPA and a competitive score on specialized entrance examinations, programs in the health professions also seek the following from competitive applicants: strong letters of recommendation, volunteer or paid experience in your specialty of interest, involvement in extracurricular activities, and research (lab) experience.

For assistance, counselors are available at Victor Valley College to help students fulfill some of the requirements to health professions schools.

Medical Assistant

The Medical Assistant is a professional, multi-skilled person dedicated to assisting in patient care management. The practitioner performs administrative and clinical duties and may manage emergency situations, facilities, and/or personnel. Competence in the field also requires that a medical assistant display professionalism, communicate effectively, and provide instructions to patients.

The medical assistant program is a one-year program that is designed to prepare students to work effectively in a physician's office, medical records or business office of a clinic or a hospital. Upon completion of the required courses, the student will demonstrate proficiency in both front and back office procedures. Successful completion of the program leads to a Certificate of Achievement.

While students are encouraged to complete the entire certificate, they are employable in the Medical Assisting field upon successful completion of ALDH 82 and 82C.

NOTE: Upon successful completion of ALDH 82 the student may enroll in ALDH 82-C (Clinical). On the first day of ALDH 82-C the student is required to bring to class the following:

1. Students must demonstrate physical health as determined by a history and physical examination.
2. The students must submit a current physical and meet required immunizations, titers, and have a chest X-ray and/or PPD. Also, a current American Heart Association Health Care Provider CPR Certificate, or equivalent, must be obtained and current. Criminal background checks are required in order to comply with the program and clinical agencies' contractual requirements. Per individual facility requirements, random drug testing may also be required.

Career Opportunities

Medical Assistant, Patient Account Representative, Receptionist, Medical Secretary, Medical Records Technician

Faculty

Diego Garcia

Degrees and Certificates Awarded

Associate in Science, Medical Assistant

Medical Assistant Certificate

Associate Degree

To earn an Associate in Science degree with a major in Medical Assistant (04956), complete the certificate requirements, three additional units in Allied Health, and meet all remaining Victor Valley College graduation requirements.

Transfer

Not a transfer major. Some Allied Health courses transfer as Electives or fulfill subject credit requirements.

Medical Assistant

MEDICAL ASSISTANT CERTIFICATE OF ACHIEVEMENT (20543)		
This certificate prepares students for an entry-level position in a physician's office, clinic, or medical records.		
Units Required: 24.0	<i>Most course descriptions may be found under Allied Health.</i>	
<i>All of the following must be completed with a grade of "C" or better:</i>		
ALDH 80	Pharmacology	3.0
ALDH 81	Medical Insurance	3.0
ALDH 82	Medical Office Procedures	4.0
ALDH 82C	Medical Office Procedures -Clinical	5.0
ALDH 139	Medical Terminology	3.0
BET 104	Beginning Word Processing/Typing-Word for Windows A/B/C	3.0
PSYC 110	Developmental Psychology*	3.0

*PSYC 110 simultaneously satisfies VVC's General Education requirement in Category IIA, Social and Behavioral Sciences.

Music

Music is the study of the language of sound and its effect on the minds and souls of creator, performer and listener. It is one of the few academic disciplines to deal extensively with the development of the creative side of personhood; in that sense it is one of the most wholly “human” of the humanities. The creative problem-solving skills and discipline of music studies prepare students for a wide range of life’s activities and pursuits. The Music Department offers a wide range of classes, providing opportunities for transfer music majors, music for general studies students, and the opportunity for student and community musicians of all skill levels to participate in a wide variety of performance ensembles.

Career Opportunities

Accompanist, Announcer, Composer/Arranger, Educator, Instrumentalist, Music Publisher, Music Sales Business Musician, Private Music Teacher, Studio Engineer, Vocalist

Faculty

David Graham | Thomas E. Miller

Degrees and Certificates Awarded

Associate in Arts, Fine Arts

Associate in Arts, Liberal Arts

Associate Degree

No associate degree offered with a major in Music. Music courses may be used to fulfill requirements for an Associate in Arts degree with a major in Fine Arts or Liberal Arts. Please see degree listings for those majors. MUSC 138 (Cooperative Education) may be used as elective credit, but may not be used to fulfill major requirements.

Transfer

Transfer music majors are required to begin major courses at the freshman level. Music majors will take the following music courses in preparation for transfer to a four-year institution: MUSC 102, 103, 104, 105, 110, 111, 202, 203, 204, 205, 210, 211, 120A and 120B. In addition, music majors must be enrolled in the appropriate performance ensemble each semester. The Music Department offers periodic workshops for transfer majors to insure that students are aware of the curriculum requirements of transfer institutions and such additional concerns as concert attendance, juries, entrance proficiency exams and scholarship and performance auditions.

For the most up-to-date information on these programs and others, visit www.assist.org. Please stop by the Transfer Center in Building 55 or make an appointment with a counselor if you have questions.

- *California State University, San Bernardino: Music major*
- *University of California, Riverside: Music major*

MUSC 100 INTRODUCTION TO MUSIC

Units: 3.0 **CSU, UC** | 48-54 hours lecture

(No prerequisite)

This course is a general introduction to the art of music, its nature, history, materials and vocabulary. The course examines the historical and contemporary value of music to the individual and society. Consideration will also be given to structural organizations of music composition and the characteristic styles of historical periods and important individuals.

MUSC 101 FUNDAMENTALS OF MUSIC

Units: 3.0 **CSU, UC** | 48-54 hours lecture

(No prerequisite)

A beginning study of the basic elements of music, including pitch and rhythm recognition, key signatures, intervals, time signatures, and major and minor scales and simple triads. Useful to those wishing to learn to sight read or play an instrument, and for those who wish to write music.

MUSC 102 MUSIC THEORY I

Units: 3.0 **CSU, UC** | 32-36 hours lecture and 48-54 hours laboratory

(Prerequisite: MUSC 101 or equivalent information as demonstrated by pretest.)

Comprehensive theory musicianship study centering on basic four part diatonic harmonic practices. Use of triads in root position in all major and minor modes, principles of voice leading including doubling, spacing, voice ranges, part crossings, basic harmonic progression, and melodic construction. Emphasis on written and aural analysis, and creative application of concepts to musical composition. Stresses programmed instruction supported by computer and electronic teaching aids in an interactive classroom environment. Required for those majoring in music and useful to those desiring to write or arrange music for any purpose.

MUSC 103 MUSIC THEORY II

Units: 3.0 **CSU, UC** | 32-36 hours lecture and 48-54 hours laboratory

(Prerequisite: MUSC 102)

Continuation of MUSC 102 Comprehensive theory study centering on basic four-part diatonic harmonic practices. Use of triads in all positions, principles of voice leading, harmonic progression, form at the phrase structure and cadence level, non harmonic tones, and melodic construction; introduction to non-dominant 7th chords, two part counterpoint and modulation. Emphasis on written and aural analysis, and creative application of concepts in a technology supported interactive classroom/lab environment. Required for those majoring in music and useful to those desiring to write or arrange music for any purpose.

MUSC 104 BASIC MUSICIANSHIP, LEVEL I

Units: 1.0 **CSU, UC** | 48-54 hours laboratory

(Prerequisite: MUSC 101 minimum grade C. Co-requisite: MUSC 102)

This course utilizes in class and computer based modalities to apply and develop the rhythmic, melodic, and harmonic materials of Music Theory I through ear training, sight singing, analysis, and dictation.

MUSC 105 BASIC MUSICIANSHIP, LEVEL II

Units: 1.0 **CSU, UC** | 48-54 hours laboratory

(Prerequisite: MUSC 104. Co-requisite: MUSC 103.)

This course uses in-classroom and computer based modalities to develop the rhythmic, melodic and harmonic materials of music theory II through ear training, sight singing, analysis and dictation.

MUSC 110 ELEMENTARY PIANO I

Units: 1.0 **CSU, UC** | 48-54 hours laboratory

(No prerequisite) (UC credit limitation)

This course offers practical keyboard facility, sight reading, elementary improvisation and harmonization of folk melodies, and performance of simple piano selections. Useful to those desiring to learn to play the piano, organ or electronic keyboards.

Music Courses

MUSC 111 ELEMENTARY PIANO II

Units: 1.0 **CSU, UC** | 48-54 hours laboratory

(Prerequisite: MUSC 110)

This course is a continuation of MUSC 110 and offers practical keyboard facility, sight reading, elementary improvisation and harmonization of folk melodies, and performance of simple piano selections. Useful to those desiring to learn to play the piano, organ or electronic keyboards.

MUSC 116 MUSIC IN AMERICA

Units: 3.0 **CSU, UC** | 48-54 hours lecture

(No prerequisite)

A survey of music in American life and culture from colonial times to the present, including both popular and art music styles.

MUSC 117 HISTORY OF JAZZ

Units: 3.0 **CSU, UC** | 48-54 hours lecture

(No prerequisite)

A survey of jazz from 1900 to the present, including definitions of jazz, African and European heritage, blues, Dixieland, ragtime, boogie woogie, swing, bop, cool, funky, gospel, third stream, free form and fusion. Lecture and structured listening and viewing.

MUSIC 118 SURVEY OF ROCK AND ROLL

Units: 3.0 **CSU, UC** | 48-54 hours lecture

(No prerequisite)

This course will discuss the unfolding of rock and roll as a modern musical genre. It will also discuss societal influence on its development as well as its impact on modern society. Other styles of contemporary commercial music will be discussed and analyzed within the general historical scope of this survey.

MUSC 120A APPLIED MUSIC STUDIES I

Units: 1.0 **CSU, UC** | 48-54 hours laboratory

(Prerequisite: Placement audition.)

Coordinates the development of the music major's performance proficiency in their primary instrument. Student will take a minimum of fifteen half-hour lessons per semester with a teacher approved by the Music Department and a minimum of three hours of on campus practice each week. All applied students will perform on faculty/student recitals and juried exams.

MUSC 120B APPLIED MUSIC STUDIES II

Units: 1.0 **CSU, UC** | 48-54 hours laboratory

(Prerequisite: MUSC 120A)

Coordinates the development of the music major's performance proficiency in the second level of their primary instrument. Student will take a minimum of fifteen half-hour lessons per semester with a teacher approved by the Music Department and a minimum of three hours of on campus practice each week. All applied students will perform on faculty/student recitals and juried exams.

MUSC 122 BEGINNING VOICE PRODUCTION I

Units: 1.0 **CSU, UC** | 48-54 hours laboratory

(No prerequisite)

Fundamental techniques of proper voice production including healthy use of the voice for speaking and singing. Teaches proper relaxation and support techniques, speech intensification, vocal freedom and resonance, and emotional support for the singing and speaking process. Designed to meet the needs of those who use their voices for solo and/or ensemble singing or in such vocally intense activities as teaching, group leading, sales, coaching, or for those taking courses in speech communication and acting.

MUSC 123 BEGINNING VOICE PRODUCTION II

Units: 1.0 **CSU, UC** | 48-54 hours laboratory

(Prerequisite: MUSC 122.)

Continued study of the techniques of proper voice production to develop healthy use of the voice for speaking and singing. Habituation of optimal techniques for relaxation, support, speech intensification, resonance, vocal freedom and developing an expressive performance persona. Will include the study of basic English and Italian diction, including use of the International Phonetics Alphabet to teach accurate and efficient diction and tone.

MUSC 124 BEGINNING GUITAR I

Units: 1.0 **CSU, UC** | 48-54 hours laboratory

(No prerequisite)

The study and performance of music for the beginning guitarist, teaching basic guitar technique and music reading skills through simple guitar pieces. Some in-class performance required.

MUSC 125 BEGINNING GUITAR II

Units: 1.0 **CSU, UC** | 48-54 hours laboratory

(No prerequisite)

This course offers further study and performance of music for the beginning guitarist. It gives the student with minimal knowledge of guitar performance the opportunity to learn basic reading skills through simple guitar pieces. Some public performance will be required.

MUSC 126 GUITAR ENSEMBLE

Units: 1.0 **CSU, UC** | 48-54 hours laboratory

(Prerequisite: MUSC 124 or MUSC 125 or equivalent.) This course may be taken four times.

This course offers the study and performance of music for guitar ensemble. It gives the student with basic knowledge of guitar performance skill the opportunity to perform in an ensemble setting. Some public performance will be required.

MUSC 128 SPECIAL TOPICS

Units: Variable units **CSU**

See Special Topics listing

MUSC 129 INDEPENDENT STUDY

Units: 1-3 units **CSU**

See Independent Study listing

MUSC 130 WOMEN'S CHOIR

Units: 1.0 **CSU, UC** | 48-54 hours laboratory

(No prerequisite.) This course may be taken three times.

A treble choir of female voices to perform repertoire from all styles and periods of music written or arranged for treble choir. Some songs may be sung in languages other than English. Emphasis on the development of the total choral musicianship skills of each singer within the group context. Choir will perform at various college and community functions.

MUSC 131 THE COLLEGE SINGERS

Units: 2.0 **CSU, UC** | 96-108 hours laboratory

(Prerequisite: Solo audition. Applicant should possess strong basic choral/vocal skills and experience in choral singing i.e. ability to sing on pitch with a well-supported, clear choral tone; strong ear able to retain and accurately recall parts learned; basic sight reading skills; team player willing to take direction. Number of singers accepted in any section may be limited by the requirements of part balance and the repertoire planned for that semester.) (Grade option) This course may be taken four times.

A select chamber choral ensemble of mixed voices to perform at various college and community functions. Repertoire includes significant choral music from all periods of music history, including motets and madrigals, part songs, masses and cantatas with orchestra, 20th century choral songs, and spirituals, vocal jazz and Broadway arrangements. Music is most often performed in the original languages. Emphasis on development of the total choral musicianship skills of each singer. Group may tour out of state or to Europe.

Music Courses

MUSC 132 MASTER ARTS CHORALE

Units: 1.0 **CSU, UC** | 48-54 hours laboratory

(Prerequisite: Solo audition to determine ability to match pitch, sing in tune, carry a harmony part, level of music reading. Prior choral experience in a high school, college/university, community or church choir desirable.) This course may be taken four times.

A large choral ensemble dedicated to the performance of major choral works from all musical periods, often with orchestra. Group may tour from time to time in the United States and abroad. Membership open by audition to all students as well as to members of the community.

MUSC 134A MUSICAL THEATRE LAB I

Units: 1.0 **CSU** | 48-54 hours laboratory

(Prerequisite: Demonstrated musical and dramatic skills as evidenced by audition. Pass/No Pass.)

A course to prepare the vocal and instrumental music for the college's musical theater and opera productions. Students will play lead, supporting or ensemble roles or participate in the pit orchestra as determined by audition.

MUSC 135 COLLEGE BAND

Units: 0.5 **CSU** | 24-27 hours laboratory

(Prerequisite: Student must audition. Pass/No Pass)

The study and performance of standard band literature composed for the intermediate level wind ensemble. Proper breathing and phrasing techniques will be emphasized along with specific instrument performance technique.

MUSC 136 COLLEGE SYMPHONIC BAND

Units: 1.0 **CSU, UC** | 48-54 hours laboratory

(Prerequisite: Appropriate level of musical performance skill as demonstrated by audition.) This course may be taken four times.

The study and performance of standard college large wind ensemble literature, stressing the proper playing and performance techniques. The development of warm up skills, scale studies, rhythmic refinement, and the full range of wind ensemble techniques will be emphasized. Public performance required.

MUSC 138 COOPERATIVE EDUCATION

Units: 1-8 Units **CSU** |

See Cooperative Education listing

MUSC 139 STUDIO JAZZ BAND

Units: 1.0 **CSU, UC** | 48-54 hours laboratory

(Prerequisite: Student must audition.)

This course provides playing experience in the fields of dance, jazz, rock and popular music. Accurate execution and consistent style will be emphasized. Attention will also be given to improvisation, sight reading, ear training and performance practice skills. Public performances at the college and in the community.

MUSC 140 STUDIO SINGERS

Units: 1.0 **CSU, UC** | 48-54 hours laboratory

(Prerequisite: Student must audition.)

Study and performance of commercial music styles written and arranged for choir in jazz, rock, gospel and popular styles. Development in healthy commercial vocal techniques, sight singing skills, ear training, improvisation and ensemble performance skills will be emphasized. Public performances at college and community concerts.

MUSC 141 JAZZ ROCK COMBO

Units: 1.0 **CSU, UC** | 48-54 hours laboratory

(Prerequisite: Student must audition.)

A study and performance of the principles and skills needed for performing in various commercial music styles in small combos. Emphasis on ensemble skills, improvisation, ear training, music theory, stylistic interpretation and performance practices. Public performances at college and community concerts.

MUSC 143 BEGINNING STRING ENSEMBLE

Units: 0.5 **CSU, UC** | 24-27 hours laboratory

(Prerequisite: Students must audition for this ensemble. Alternative course is MUSC 137. Pass/No Pass) This course may be taken four times.

This course will be a beginning study and performance of standard string orchestra literature composed for the beginning string player. Proper left hand position (excluding the use of third position), beginning bow techniques, appropriate performance practices will be emphasized.

MUSC 144 PRELUDIUM STRING ENSEMBLE

Units: 0.5 **CSU** | 24-27 hours laboratory

(Prerequisite: Student must audition. Pass/No Pass) This course may be taken four times.

A study and performance of standard string orchestra literature. Proper left hand position, bowing techniques and appropriate performance practices will be emphasized. College and community performances.

MUSC 145 COLLEGE SYMPHONY ORCHESTRA

Units: 1.0 **CSU, UC** | 48-54 hours laboratory

(Prerequisite: Appropriate level of performance on instrument as demonstrated by audition.) This course may be taken four times.

A study and performance of standard full orchestral literature. Emphasis on ensemble skills, ear training and performance practices. Public performances at college and community concerts.

MUSC 147 INSTRUMENTAL ENSEMBLE

Units: 0.5 **CSU, UC** | 24-27 hours laboratory

(Prerequisite: Appropriate level of musical performance skill as demonstrated by audition. Pass/No Pass) This course may be taken four times.

This course will explore small ensemble literature and performance from the Renaissance to the present for small ensembles of wind and brass instruments. Specific technical skills will be addressed including breathing, phrasing, tonguing and ornamentation practices. Student should check with the music program to determine what specific instrumental groupings will be formed that semester. Public performances are required.

MUSC 202 INTERMEDIATE THEORY-- CHROMATIC PRACTICE PART I

Units: 3.0 **CSU, UC** | 32-36 hours lecture and 48-54 hours laboratory

(Prerequisite: MUSC 103)

The study of chromatic harmonic practices, including all types of seventh chords, dominant seventh and leading tone seventh functions, secondary dominants and secondary leading tone chords, altered non harmonic tones, modulation to closely related keys, and borrowed chords and introduction to Neapolitan and augmented 6th chords.

MUSC 203 INTERMEDIATE THEORY-- CHROMATIC PRACTICE, PART II

Units: 3.0 **CSU, UC** | 32-36 hours lecture and 48-54 hours laboratory

(Prerequisite: MUSC 202)

Completes the chromatic harmony studies begun in MUSC 202 through use of foreign/ enharmonic modulations, borrowed and augmented chords, Neapolitan and other sixth chords, chromatic third relation harmony and ninth, eleventh and thirteenth chords, and introduces 20th century concepts including impressionism, bitonality, atonality, 12 tone and set theory, minimalism and new rhythmic concepts.

MUSC 204 INTERMEDIATE MUSCIANSHIP I

Units: 1.0 **CSU, UC** | 48-54 hours laboratory

(Prerequisite: MUSC 105)

This course uses in class and computer based applications to develop the rhythmic, melodic, and harmonic materials of Intermediate Theory I through ear training, sight singing, analysis, and dictation.

Music Courses

MUSC 205 INTERMEDIATE MUSCIANSHIP II

Units: 1.0 [CSU, UC](#) | 48-54 hours laboratory

(Prerequisite: MUSC 204)

This course applies and develops, through in class and computer aided instruction, the rhythmic, melodic, and harmonic materials of Music Theory IV through ear training, sight singing, analysis, and dictation.

MUSC 210 INTERMEDIATE PIANO I

Units: 1.0 [CSU, UC](#) | 48-54 hours laboratory

(Prerequisite: MUSC 111)

This course offers the continued development of keyboard facility from MUSC 111 including harmonization of given melodies using appropriate intermediate accompaniments, furthered exploration of piano repertoire and related skills, styles and technical exercises. Two octave major and minor scales, arpeggios, and harmonization skills will be explored.

MUSC 211 INTERMEDIATE PIANO II

Units: 1.0 [CSU, UC](#) | 48-54 hours laboratory

(Prerequisite: MUSC 210)

This course offers the continuation and development of practical keyboard facility from Music 210, including sight reading, harmonization of given melodies through the use of appropriate accompaniments, exploration of piano repertoire and related stylistic and technical exercises. Useful to those wishing to further the development of keyboard skills.

MUSC 220A APPLIED MUSIC STUDIES II

Units: 1.0 [CSU](#) | 48-54 hours laboratory

(Prerequisite: MUSC 120B.)

Coordinates the 3rd level of the development of the music major's performance proficiency in their primary instrument or voice. Student will take a minimum of fifteen half hour lessons per semester with a teacher approved by the Music Department and at least three hours of individual practice each week. Payment for lessons will be worked out directly between the teacher and student. All applied students will perform on faculty/student recitals and jury exams.

MUSC 220B APPLIED MUSIC STUDIES IV

Units: 1.0 [CSU](#) | 48-54 hours laboratory

(Prerequisite: MUSC 220A)

Coordinates the 4th level of the development of the music major's performance proficiency in their primary instrument or voice. Student will take a minimum of fifteen half hour lessons per semester with a teacher approved by the Music Department and at least three hours of practice on campus each week. All applied students will perform on faculty/student recitals and jury exams.

MUSC 222 INTERMEDIATE VOICE PRODUCTION I

Units: 1.0 [CSU, UC](#) | 48-54 hours laboratory

(Prerequisite: MUSC 122)

Study and refinement of the techniques of proper voice production to develop healthy use of the voice for speaking and singing. Habituation of optimal techniques for relaxation, support, speech intensification, resonance, vocal freedom and developing an expressive performance persona. Will include the study of basic German singing diction, including use of the International Phonetics Alphabet to teach accurate and efficient diction and tone.

MUSC 223 INTERMEDIATE VOICE PRODUCTION II

Units: 1.0 [CSU](#) | 48-54 hours laboratory

(Prerequisite: MUSC 122)

Further study and refinement of the techniques of proper voice production to develop healthy use of the voice for speaking and singing. Habituation of optimal techniques for relaxation, support, speech intensification, resonance, vocal freedom and developing an expressive performance persona. Will include the study of basic French singing diction, including use of the International Phonetics Alphabet to teach accurate and efficient diction and tone.

The Associate of Science Degree in Nursing is approved by the California Board of Registered Nursing. Graduates are eligible to take the National Council for Licensure Examination for Registered Nursing (NCLEX-RN) and, upon successful completion, become eligible for licensure as a Registered Nurse in the state of California.

California law allows for the denial of Registered Nurse Licensure on the basis of any conviction or action substantially related to nursing practice. The California Board of Registered Nursing requires applicants for licensure with prior convictions to provide proof of rehabilitation before taking the NCLEX-RN that establishes fitness for performing nursing functions. For further clarification, contact the Nursing Department or the California Board of Registered Nursing.

The Associate Degree Nursing Faculty accepts and operates within the framework of the philosophy and mission of Victor Valley College. The conceptual framework is based on the systems and change theory using the Nursing Process. The components of the curriculum are arranged around the client's bio-psycho-social, and cultural/spiritual beliefs. The faculty believes that the student is an adult learner who is expected to take an active role in the learning process.

Separate application must be made into the nursing program. Several admission and progression options are available, including generic, advanced placement, transfer, non-graduate and 30 unit option. Specific information is available in the application packet, the student nurse handbook and from the program director. Please contact the Nursing Department for application dates.

Prerequisites for admission into the nursing program

1. Human Anatomy (equivalent to Victor Valley College BIOL 211), 4-5 units, completed with a grade of "C" or better.
2. Human Physiology (equivalent to Victor Valley College BIOL 231), 4-5 units, completed with a grade of "C" or better.
3. Microbiology (equivalent to Victor Valley College BIOL 221), 5 units, completed with a grade of "C" or better.
4. Program prerequisites must be completed prior to application.

Note that these prerequisites themselves have prerequisites: MATH 90; CHEM 100; and BIOL 107 (preferred) or 100.

Enrollment Process

After the prerequisites have been verified and there are still too many students for the spaces available, those accepted into the program will be based on the enrollment criteria. The enrollment process is based on the recommended Best Practice for Enrollment prepared by the Chancellor's Office of the California Community Colleges, and approved by the Chancellor's Office. Please contact the Nursing Department or Nursing Counselor for further clarification of the enrollment process.

NOTE:

1. Prior to admission to the ADN program, students must demonstrate physical health as determined by a history and physical examination.
2. To continue in the program, the students must submit a current physical and meet required immunizations, titers, and have a chest X-ray and/or PPD. Also, a current American Heart Association Health Care Provider CPR Certificate, or equivalent, must be obtained and current. Current liability insurance and criminal background checks are required in order to comply with the program and clinical agencies' contractual requirements. Per individual facility requirements, random drug testing may also be required.
3. The College does not provide transportation to and from required clinical facilities.
4. In order to continue in the ADN program students must earn a minimum grade of C in all nursing and other required courses.
5. Nursing courses have specific prerequisites. Refer to course descriptions in this catalog.

Career Opportunities

The graduate is prepared to practice nursing at any entry level in the following settings:

Medical/Surgical Nursing, Psychiatric Nursing, Maternal/Newborn Nursing, Post-Anesthesia Nursing, Perioperative Nursing, Geriatric Nursing, Critical Care Nursing, Rehabilitation Nursing, Neurosurgical Nursing, Oncology Nursing

Faculty

Diane Cline - Emeritus | Starlie Luna | Diego Garcia Renata Longoria | JoAnn Munroe
Silvia Portillo | Alice Ramming | Jeanine Speakman | Lois Trudeau | Terry Truelove

Degrees and Certificates Awarded

Associate in Science, Nursing

Associate Degree Nursing Certificate

Nursing Licensure Certificate

Program Learning Outcomes

A student receiving a degree or certificate in this field will be able to:

- Demonstrate clear, culturally sensitive communication with patients, peers, & healthcare staff; documenting clearly care plans which address cultural, developmental, bio-psychosocial and spiritual needs and how they are met.
- Calculate drug dosages for all age groups with 100% accuracy and use current technology according to industry standards.
- After completing an assessment, state appropriate nursing diagnosis, formulate a plan of care which is culturally and age sensitive; implement and evaluate outcomes for patient.
- Practice legally, ethically, and professionally while acting as the patient's advocate.
- Eighty-five percent of the graduates will demonstrate overall competence by successfully passing the NCLEX licensure exam (on the first attempt).

Associate Degree

To earn an Associate in Science degree with a major in Nursing (04955) one must complete all certificate courses and meet all Victor Valley College graduation requirements. The Associate Degree Nursing Certificate includes all requirements for both a certificate and an Associate in Science degree in Nursing. The Nursing Licensure Certificate requires additional general education courses to complete an associate degree. The Nursing Licensure Certificate precludes receiving the Associate Degree in Science with a major in nursing.

Transfer

Acceptance into a baccalaureate of science degree in Nursing is based on completion of prerequisites and entrance requirements. To pursue a BSN, complete the following requirements prior to transfer. Visit www.assist.org for the most current information.

- **California State University, Dominguez Hills:** RN to BSN program

1. Minimum of 60 semester units of transferable college credit with a grade point average of at least 2.0 (C) or better in all transferable course work (non-residents: 2.4) and have satisfied any high school subject deficiency in English and mathematics by equivalent course work (the maximum transferable credit accepted from a two-year college is 70 semester units). English composition, Public Speaking, GE Math and Logic/Critical Thinking must be completed prior to admission for new applicants.
2. Current RN licensure in the United States, or an RN interim permit.
3. It is recommended that students obtain GE certification from a community college prior to admission.

- **California State University, San Bernardino:** BSN program

1. Completion of an application to the university and nursing program
2. Attendance at a group advising session
3. Completion of the following prerequisites:
BIOL 211, BIOL 231, BIOL 221, CHEM 100, MATH 105 or H105 or MATH 132, CMST 109, ENGL 101; PSYC 110; and complete the CSU General Education/Breadth pattern.
4. 3.5 GPA minimum
5. "C" or better on all course work

Placement Options

GENERIC STUDENTS are those who will complete the entire nursing program at Victor Valley College.

The application is submitted, and after approval, class selection is made according to the current enrollment process. Students must also pass (=>62%) the Testing of Essential Academic Skills (TEAS V) prior to program start. The TEAS V Exam tests the student's knowledge of basic Math, English, Reading and applicable science. A maximum of two attempts to pass the TEAS V or higher version is allowable.

TRANSFER STUDENTS are those who transfer nursing units from another college.

The education code allows students to transfer only lower division units to a community college. Each student requesting transfer of Nursing units will be individually evaluated by the Nursing Program Admission, Promotion and Program Effectiveness (AEPE) Committee to determine appropriate placement in the VVC Program. Placement will be made on a space available basis and is determined by the course content and number of nursing degree units completed. A Priority Transfer List will be established according to the Policy for Nursing Program Transfer. Students will be given credit for general education courses according to the college's published policy (see College Catalog). If the student has earned a non-progression grade (D or F) in a registered nursing at another school, acceptance to Victor Valley College Nursing Program will be considered their second chance. Prospective students must score a minimum of 62% on the TEAS V or higher version.

LVN TO RN ENTRY OPTION are those documented as a Licensed Vocational Nurse (LVN) in California. Students choosing this option must apply to the program, meet the prerequisites (Completion of college-level Anatomy, Physiology and Microbiology) and take the Credit by Examination for NURS 246 (Assessment and Nursing Skills). LVN-RN Entry Option placement students must pass the Credit by Examination for NURS 246. Applications for this option are accepted in the winter and summer. Program placement for NURS 221 will be in fall and spring respectfully. Passing TEAS V or higher version is also a requirement for all entering students.

*(LVN-RN) Please note: All Victor Valley College requirements for Credit by Examination must also be met. 1) Twelve units completed at VVC. 2) Minimum overall cumulative GPA of 2.0. 3) No previous grade received for the course. 4) Currently enrolled. NOTE: Credit by Examination may only be taken once for a course.

CHALLENGE STUDENTS

Students admitted to the Nursing Program with previous documented experience may be allowed to challenge certain specified content areas (Education Code, Section 5557537), Title 5 of the California Administrative Code.) (Contact the Director of Nursing regarding this option.)

THIRTY UNIT OPTION is available to California Licensed Vocational Nurses. The Board of Registered Nursing regulation 1435.5 provides the option of completing 30 semester units in nursing and related sciences. In order to enter under this option the applicant must: 1) Have a current California LVN license; 2) Prior to starting NURS 246, have previously completed Human Physiology, 4 units with a lab, and Microbiology, 4 units with a lab; both with C or better. 3) Prior to starting NURS 223 & NUR 224, NURS 246 must be completed with a C or better. After successfully completing NURS 246, candidates will enter NURS 223 and complete NURS 223 and NURS 224. Candidates completing this option are not graduates of VVC, but are eligible to take the licensure exam. They are not eligible to wear the VVC graduate nursing pin nor graduate from the Associate Degree program. Additionally, they may not be eligible for RN licensure in any other state than California. Passing the TEAS V is also a requirement for the 30-Unit Option students.

NON-GRADUATE OPTION

Allows students to complete only those classes required to take the NCLEX exam. In the VVC Nursing Program, those classes are: BIOL 211, 221, 231; ENGL 101; SOC 101, CMST 106, 107, 108, or 109; PSYC 101, PSYC 110; NURS (5 classes) All classes must be completed with a C or better. Students choosing this option are not graduates of VVC. The TEAS V requirement applies to all entry options.

Contracts or Grants

The Nursing program reserves the right to bypass portions of the enrollment process to designate a certain number of spaces from any of the above entry options for contracts, grants, pilot programs or partnerships, and/or to meet requirements of grant-designated outcomes.

For detailed information regarding VVC's Associate Degree Nursing Program Placement/Advancement Policy, please refer to the current ADN Program Student Handbook.

Nursing, AS (04955)**Units Required: 80.0***Nursing Core*

NURS 220	Pharmacology and Nursing Management	2.0
NURS 221	Nursing Process 1	10.0
NURS 222	Nursing Process 2	9.0
NURS 223	Nursing Process 3	9.0
NURS 224	Nursing Process 4	9.0
NURS 246	Assessment and Nursing Skills	3.0

Group A: All of the following must be completed:

BIOL 211	Human Anatomy	5.0
BIOL 221	General Microbiology	5.0
BIOL 231	Human Physiology	5.0
ENGL 101	English Composition and Reading	4.0
PSYC 101	General Psychology	3.0
PSYC 110	Developmental Psychology	3.0
SOC 101	Introduction to Sociology	3.0

Group B: One of the following must be completed:

CMST 106	Human Communication	3.0
CMST 107	Family Communication	3.0
CMST 108	Group Discussion	3.0
CMST 109	Public Speaking	3.0

*One course which meets the VVC Mathematics general education requirement for Category V**One course which meets the VVC Humanities general education requirement for Category III**One course which meets the VVC American Institutions general education requirement for Category IIB. One unit of Physical Education. Each class must be completed with a grade of "C" or better.***NURSING LICENSURE CERTIFICATE OF ACHIEVEMENT (20545)****Units Required: 67.0***Each class must be completed with a grade of "C" or better.*

BIOL 211	Human Anatomy	5.0
BIOL 231	Human Physiology	5.0
BIOL 221	General Microbiology	5.0
SOC 101	Introduction to Sociology	3.0
PSYC 101	General Psychology	3.0
PSYC 110	Developmental Psychology	3.0

Complete one of the following:

CMST 106	Human Communication	3.0
CMST 107	Family Communication	3.0
CMST 108	Group Discussion	3.0
CMST 109	Public Speaking	3.0

Each class must be completed with a grade of "C" or better.

ENGL 101	English Composition and Reading	3.0
NURS 220	Pharmacology and Nursing Management	2.0
NURS 221	Nursing Process 1	10.0
NURS 222	Nursing Process 2	9.0
NURS 223	Nursing Process 3	9.0
NURS 224	Nursing Process 4	9.0
NURS 246	Assessment and Nursing Skills	3.0

NURS 138 COOPERATIVE EDUCATION

(See Cooperative Education 1-8 units). **CSU**

NURS 148 SPECIAL TOPICS

See Special Topics listing (Variable units). **CSU**

NURS 149 INDEPENDENT STUDY

See Independent Study listing (1-3 units). **CSU**

NURS 220 PHARMACOLOGY AND NURSING MANAGEMENT

Units: 2.0 **CSU** | 32-36 hours lecture

(Prerequisite: BIOL 211, BIOL 221, BIOL 231 completed with a minimum grade of 'C', TEAS V or TEAS score 62% or better, and admission to the Nursing Program as required by BRN.)

This course is a nursing class about the study of drug therapy to prevent, diagnose, or cure disease processes or to relieve signs and symptoms of diseases. It includes content specific to the registered nurse and utilization of the nursing process to fulfill nursing responsibility in medication management of clients.

NURS 221 NURSING PROCESS 1

Units: 10.0 **CSU** | 80-90 hours lecture and 240-270 hours laboratory

(Prerequisite: NURS 220, and NURS 246 all completed with a minimum grade of 'C')

An introduction to the Victor Valley College Associate Degree Nursing Program and the nursing profession. Emphasis is on the nursing process and fundamentals of nursing; including risk management, health promotion, psycho-social aspects, electrolyte and acid-base management, and the perioperative experience practiced in various clinical settings and the classroom laboratory.

NURS 222 NURSING PROCESS 2

Units: 9.0 **CSU** | 64-72 hours lecture and 240-270 hours laboratory

(Prerequisite: NURS 221 completed with a grade of 'C' or better.)

The Nursing Process applied to family nursing and the childbearing family, the adaptations of nursing care for various stages of growth and development, and the nursing management required in common adult conditions; e.g., nutritional, tissue perfusion, elimination.

NURS 223 NURSING PROCESS 3

Units: 9.0 **CSU** | 64-72 hours lecture and 240-270 hours laboratory

(Prerequisite: NURS 222)

This course will synthesize and correlate nursing knowledge and skills in providing care to multiple patients who have complex, multi-system illnesses. Focus will be for the students to predict patient needs and priorities, and evaluate outcomes of care. Associated psychomotor skills will be integrated and practiced.

NURS 224 NURSING PROCESS 4

Units: 9.0 **CSU** | 64-72 hours lecture and 240-270 hours laboratory

(Prerequisite: NURS 223)

The Nursing Process applied with a holistic view to multi-system problems with a comprehensive approach in the hospital and community setting. Clinical experience demonstrates the use of legal, ethical, and leadership principles, and the ability to function with minimum supervision as a preceptor.

NURS 226 CRITICAL CARDIAC and RESPIRATORY NURSING

Units: 2.0 **CSU** | 32-36 hours lecture

(Prerequisites: NURS 222 and/or licensed as a Registered Nurse or Licensed Vocational Nurse. Grade Option)

This optional nursing course provides an introduction to critical care nursing concepts with an emphasis on clients with complex cardiac and respiratory problems, seen primarily in the critical care environment. Pathophysiology, diagnosis, treatment and nursing implication for patients in the critical care area will be discussed. This course will primarily benefit students going into their third semester of nursing.

Nursing Courses

NURS 246 ASSESSMENT AND NURSING SKILLS

Units: 3.0 CSU | 32-36 hours lecture and 48-54 hours laboratory

(Prerequisite: BIOL 211, BIOL 221, BIOL 231 completed with a minimum grade of 'C'; TEAS V or TEAS score 62% or better, and acceptance into the VVC Nursing Program.)

Focuses on development of assessment skills including obtaining a health history, performing physical assessment of the adult, and evaluating physiologic changes related to aging and pediatric patient population. Emphasis on developing interviewing skills, assessing cultural factors, and utilization of basic assessment techniques.

Oceanography

OCEA 101 OCEANOGRAPHY

Units: 3.0 [CSU, UC](#) | 48-54 hours laboratory

(No Prerequisite)

An introduction to the marine environment. Methods and techniques of exploration, physics, and chemistry of the oceans; adaptations of organisms; significance of the marine environment to man. A general survey of the major aspects of oceanography; history, topography, geography, geology, chemistry, physics, meteorology, biology, and resource management.



Paralegal Studies

The legal profession has evolved to include more paraprofessional assistance in the delivery of legal services to the consumer. Current economic trends and technologies find paralegals filling a space in the consumer market that was once filled only by attorneys. Law firms and corporate legal departments rely on paralegals as cost saving measures forwarded to the client. The Paralegal occupation is expected to grow at a faster than average rate through 2018 according to the Department of Labor, Bureau of Labor Statistics.

The paralegal program at Victor Valley College prepares students to work in the legal industry by introducing students to legal theory which leads to employment in administrative agencies, governmental agencies, corporations, insurance companies, human resources departments, private and public law offices and other legal environments. Paralegals duties include performing factual and legal research and investigation, drafting legal documents and correspondence, interviewing clients and witnesses, trial preparation and organizing and maintaining court files. Training students in the practical application and the development of current paralegal related job skills is emphasized. Paralegals students will learn to adopt and use computer technology skills in the law setting, using electronic databases and research tools.

There are two types of legal industry paraprofessionals. California Business and Professions Codes 6400 (c) and California Business and Professions Code 6450 (a) define the duties, responsibilities and obligations that the industry and state regulate.

“ Paralegals may not provide legal services directly to the public except as permitted by law”.

The primary goal of the paralegal program is to educate and prepare students for employment as paralegals where they can demonstrate competency and ethical standards demanded by and of the profession.

Students must, before entering the program, complete English 101/101H or assess at an English 101 level. The sequencing of courses has been designed to enhance student success in the field. PAL 100, 102, and 103 are the foundational classes that are prerequisite to the higher level legal specialty classes. These three classes should optimally be taken concurrently to provide that firm foundation for success. PAL 104 may be taken concurrent with PAL 100, 102 and 103, but may be taken at any time. A firm foundation in writing and grammar skills and completion of POLS 102 are recommended. This is not a four year transfer program, is not a substitute for law school, nor is it intended to be used for advanced standing in law school applications. It is not a pre-law program. It is not intended to serve as a preparation for bar examination.

At this time, VVC offers PAL 204, Wills and Trusts, and PAL 205, Bankruptcy, but have not yet been incorporated, as electives or core classes, into the certificate award. However, these classes are required classes for the NEW Advanced Paralegal Certificate offered at Victor Valley College. Please see below for the Certificate requirements.

Degrees and Certificates Awarded

Advanced Paralegal Studies Certificate

Paralegal Studies Certificate

Associate Degree

At this time, Victor Valley College does not offer an associate degree with a major in Paralegal Studies.

Transfer

For the most up-to-date information on this program and others, visit www.assist.org. Please stop by the Transfer Center in Building 55 or make an appointment with a counselor if you have questions.

- **California State University, San Bernardino:** Criminal Justice major, Paralegal Studies concentration

Course Sequences

English 101/H101 → (Completion of POLS 102 is strongly recommended prior to the Paralegal classes)
↓

PAL 100 with → PAL 102 (first 8 weeks) → PAL 103 (second 8 weeks)

↓
PAL 104

↓
PAL 201

↓
PAL 202 / PAL 203

Note: After completing PAL 201, students may take the elective courses PAL 204 and PAL 205.

2017-2018 Victor Valley College Catalog

ADVANCE PARALEGAL STUDIES CERTIFICATE OF CAREER PREPARATION		
Students must complete a minimum of 17 units, with at least 6 units taken in residence at Victor Valley College, with a minimum grade of "C" in all paralegal classes.		
Units Required: 17.0		
<i>Group I — All of the following must be completed:</i>		
PAL 101	Law Office Technology for Paralegals	3.0
PAL 200	Law Office Management for Paralegals	2.0
PAL 204	Wills and Trusts for Paralegals	3.0
PAL 205	Basic Bankruptcy Law for Paralegals	3.0
<i>Group II — At least 6 units of the following must be completed:</i>		
BADM 116	Human Relations in Business	3.0
BADM 118	Business Law	3.0
BRE 110	Legal Aspects of Real Estate I	3.0
PAL 206	California Employment and Labor Law	3.0
PAL 207	Conflict Resolution and Negotiations	3.0
PARALEGAL STUDIES CERTIFICATE OF ACHIEVEMENT (11836)		
Students must complete a minimum of 36 units, with at least 12 units taken in residence at Victor Valley College, with a minimum grade of "C" in all paralegal classes. Most Paralegal course descriptions may be found under Political Science.		
Units Required: 36.0		
<i>Group I — All of the following must be completed:</i>		
AJ 103	Criminal Law	3.0
BADM 117	Legal Environment of Business	3.0
PAL 100	Introduction to Paralegal Studies	3.0
PAL 102	Beginning Legal Research for Paralegals	3.0
PAL 103	Legal Writing for Paralegals	3.0
PAL 104	Legal Ethics for Paralegals	3.0
PAL 201	Fundamentals of Litigation for Paralegals	3.0
PAL 202	Family Law	3.0
PAL 203	Tort Law for Paralegals	3.0
<i>Group II — At least 9 units of the following must be completed:</i>		
AJ 102	Criminal Procedures	3.0
AJ 104	Legal Aspects of Evidence	3.0
BADM 101	Financial Accounting <i>or</i>	4.0
BADM 103	Financial Accounting Fundamentals	3.0
BET 104	Beginning Word Processing/Typing Word for Windows A/B/C	1-3
BRE 110	Legal Aspects of Real Estate I	3.0
CMST 109	Public Speaking	3.0
ENGL 104/104H	Critical Thinking and Composition	3.0
PHIL 109	Introduction to Logic	3.0

Note: After completing PAL 201, students may take the elective courses PAL 204 and PAL 205.

Paralegal Studies Courses

PAL 100 INTRODUCTION TO PARALEGAL STUDIES

Units: 3.0 CSU 48-54 hours lecture

(Prerequisite: ENGL 101.0 or ENGL H101)

This is the beginning course for students pursuing a Certificate of Paralegal Studies. Students will learn the nature of the career field, the skills and knowledge required, the ethical requirements, the background in court systems, and the legal research and writing that are necessary for success in the profession. The emphasis is placed on functions of a paralegal within a private law firm, within a government agency, as a business owner, and as a litigation assistant.

PAL 101 LAW OFFICE TECHNOLOGY FOR PARALEGALS

Units: 3.0 CSU 48-54 hours lecture

(Co-requisite: PAL 100)

This class introduces the students to the legal industry technology utilized in the current legal environment. Skills developed include document creation and assembly, spreadsheet software, and data and case management. Students will gain an understanding of the growing and critical role of electronic discovery in litigation, including electronic discovery rules of law, workflow and processes, and the production of electronically stored information. Students will be introduced to litigation support and case management software, and introduction to paperless presentation tools used in today's courtrooms.

PAL 102 BEGINNING LEGAL RESEARCH FOR PARALEGALS

Units: 3.0 CSU 48-54 hours lecture

(Prerequisite/Co-requisite: PAL 100 (POLS 130))

This course provides the paralegal student with a beginning introduction to the sources and means of legal research. The course will focus on developing the student's ability to locate and use various types of legal authority including legal encyclopedias, constitutions, statutes, court opinions, administrative regulations, and appellate decisions. The student will be expected to learn and practice Shepardizing and citation checking skills.

PAL 103 BEGINNING LEGAL WRITING

Units: 3.0 CSU 48-54 hours lecture

(Prerequisite/Co-requisite: PAL 102)

This course provides the paralegal student with the development of good legal writing skills. Critical analysis of proper legal writing forms stressing logic, clarity and format will be used to shape the paralegal student's ability to produce such legal documents as correspondence, legal briefs, memorandum of law, pleadings, and appellate briefs.

PAL 104 LEGAL ETHICS FOR PARALEGALS

Units: 3.0 CSU 48-54 hours lecture

(Prerequisite: None)

This course examines the role of the paralegal in the rendering of legal services by attorneys to clients and the ethical rules that govern that relationship. The student will become familiar with the concept of the unauthorized practice of law, the criminal penalties such practices carry and the best means to avoid liability. Comprehensive study of the ABA's Model Rules of Professional Conduct will give the student a broad base from which to operate ethically and legally as a paralegal.

PAL 200 LAW OFFICE MANAGEMENT FOR PARALEGALS

Units: 2.0 CSU 32-36 hours lecture

(Prerequisite: PAL 100)

Introduction to the role of the paralegal in law office management and practice procedures, including managerial challenges in a legal environment, office activities, policies, and role of the office administrator, comprehensive understanding of financial resources, human resources, risk management, and supervision unique to the legal environment.

Paralegal Studies Courses

PAL 201 FUNDAMENTALS OF LITIGATION FOR PARALEGALS

Units: 3.0 **CSU** | **48-54 hours lecture**

(Prerequisite: PAL 103 minimum grade C (POLS 136))

This course examines the intricate working of the American court system and the role of the paralegal in litigation practice. This course will focus on the process that begins with the client interview, extends through the filing, develops into the discovery state, takes final shape in the trial stage and ends with enforcement of a judgment. Critical analysis of statutory and judicial rules for the conduct of litigation will be used extensively to provide a strong foundation for operating within the legal field.

PAL 202 FAMILY LAW

Units: 3.0 **CSU** | **48-54 hours lecture**

(Corequisite: PAL 201)

This course examines Family Law rules and procedures for the paralegal working in a California family law practice. Concepts covered include marital contracts, annulment, separation, dissolution, child custody and support, spousal support, property division, and tax consequences of family law procedures. Included will be current topics in family law such as demise of marriage, same-sex unions, adoptions, and practice and procedure.

PAL 203 TORT LAW FOR PARALEGALS

Units: 3.0 **CSU** | **48-54 hours lecture**

(Corequisite: PAL 201)

This course introduces the paralegal to the world of tort law; takes them through the basic concepts that are the foundation of negligence litigation (duty, breach, causation, damages), intentional torts to both persons and property, and strict liability. Introduces the student to investigative procedures in personal injury cases.

PAL 204 WILLS AND TRUSTS FOR PARALEGALS

Units: 3.0 **CSU** | **48-54 hours lecture**

(Prerequisite: PAL 201 minimum grade C.)

This course introduces the paralegal student to the laws of wills, trusts and estates, including the creation of wills, testate succession, intestate succession, trust creation and arrangements, family protection, estate planning, probate courts, and estate taxes.

PAL 205 BASIC BANKRUPTCY LAW FOR PARALEGALS

Units: 3.0 **CSU** | **48-54 hours lecture**

(Prerequisite: PAL 201 minimum grade C.)

This course is an introduction to the Federal Bankruptcy law, with emphasis on Chapter 7 Bankruptcies, and discussions and introduction to Chapter 11 and 13 proceedings. The student will complete an entire Chapter 7 Bankruptcy petition and other documents and motions involving a bankruptcy case under the Bankruptcy Code. Included will be creditors' claims and motions for relief of automatic stay.

Philosophy

The study of philosophy is dedicated to reflection on the most fundamental concerns of human life. Students examine and assess the concepts and arguments expressed in writings of influential philosophers on such enduring themes as moral value, religious knowledge, political order, truth, and ultimate reality. Philosophical study assists students in developing such valuable and transferable skills as analytical reading and writing, creative and critical thinking, and sound judgment.

Career Opportunities

(Most careers require a bachelor's or advanced degree.)

Corporate Manager, Ethics Consultant, Lawyer, Management Trainer, Public Administrator, Religious Leader
Social Worker, Teacher, Writer

Faculty

Daniel Vecchio | Marc Skuster-Emeritus

Degrees and Certificates Awarded

Associate in Arts, Liberal Arts

Associate Degree

No associate degree offered with a major in Philosophy. Philosophy courses may be used to fulfill requirements for an Associate in Arts degree with a major in Liberal Arts. See Liberal Arts for degree requirements for this major.

Transfer

To pursue a bachelor's degree in this field, here are some schools that have programs that might interest you. For the most up-to-date information on these programs and others, visit www.assist.org. Please stop by the Transfer Center in Building 55 or make an appointment with a counselor if you have questions.

- **California State University, San Bernardino:** *Philosophy major*
- **University of California, Riverside:** *Philosophy major*

Philosophy Courses

PHIL 101 INTRODUCTION TO PHILOSOPHY

Units: 3.0 **CSU, UC** | 48-54 hours lecture

(No prerequisite. Recommended preparation: ENGL 50 or eligibility for ENGL 101.0/H101)

Introduction to the methods and subject matter of the discipline of philosophy through critical analysis of primary texts and discussion of enduring questions regarding reality, knowledge, and value. Topics include the sources and limits of knowledge; the nature of reality, mind, and personal identity; the existence of God and religious experience; moral value; philosophy of science; the nature of truth; distributive justice; and the meaning of life.

PHIL 108 INTRODUCTION TO ETHICS AND CONTEMPORARY MORAL ISSUES

Units: 3.0 **CSU, UC** | 48-54 hours lecture

(No prerequisite. Recommended preparation: Eligibility for ENGL 101.0/H101)

Critical study of major ethical theories and their application to contemporary moral issues in bio-medical practice, law and violence, sexuality, social and economic justice, the environment, and business conduct.

PHIL 109 INTRODUCTION TO LOGIC

Units: 3.0 **CSU, UC** | 48-54 hours lecture

(No prerequisite)

Introduction to the principles and practice of sound reasoning: argument analysis and evaluation, induction, deduction, fallacies, categorical logic, and propositional logic. Assignments require use of the computer.

PHIL 114 POLITICAL PHILOSOPHY

Units: 3.0 [CSU, UC](#) | 48-54 hours lecture

(No prerequisite. Recommended preparation: Eligibility for ENGL 101.0/H101.)

Introduction to the normative discussion of social organization from a variety of philosophical perspectives. Topics include the nature of the state, rights, the role of law, liberty, distributive justice, and the common good. Emphasis on the American social experience with additional attention given to the global context. No prerequisite. ENGL 101.0 recommended See cross listing for POLS 114.

PHIL 117 PHILOSOPHY OF RELIGION

Units: 3.0 [CSU, UC](#) | 48-54 hours lecture

(Recommended preparation: ENGL 50 or eligibility for ENGL 101.0.)

Introduction to major topics in the philosophy of religion: the existence and nature of God, religious experience and knowledge, and concepts of immortality and human destiny. Special attention is given to conflicts between religion and science, competing claims for religious truth, and the relevance of religion to social ethics. Three lecture hours per week. See cross-listing for RLST 117.

PHIL 120 HISTORY OF ANCIENT PHILOSOPHY

Units: 3.0 [CSU, UC](#) | 48-54 hours lecture

(No prerequisite. Recommended preparation: Eligibility for ENGL 101.0/H101.)

Critical study of the major movements, figures, and influential texts in the ancient period of Western Philosophy: the Pre-Socratics, Socrates, Plato, and Aristotle. Discussion of the influence of Greek thought on Hellenistic, Roman, and Medieval philosophy.

PHIL 121 HISTORY OF MODERN PHILOSOPHY

Units: 3.0 [CSU, UC](#) | 48-54 hours lecture

(No prerequisite. Recommended preparation: Eligibility ENGL 101.0/H101.)

Introduction to major Western philosophers and movements from the 16th through the 18th Centuries. Emphasis on primary source readings representative of Continental Rationalism, British Empiricism, and Kant, with some attention given to precursors and following developments

PHIL 128 SPECIAL TOPICS

See Special Topics listing (Variable units). [CSU](#)

PHIL 129 INDEPENDENT STUDY

See Independent Study listing (1-3 units). [CSU](#)

PHIL 207 INTRODUCTION TO CRITICAL THINKING

Units: 3.0 [CSU, UC](#) | 48-54 hours lecture

(Prerequisite: ENGL 101.0/101H minimum grade C).

Study and practice in critical thinking and advanced English composition: analysis, evaluation, and formulation of arguments; critical study of texts; and extended argumentative writing. Application of critical thinking and writing skills to current moral, social, and religious issues. See cross listing for RLST 207

Photography

The study of photography offers a multitude of career possibilities. From fine art to commercial applications, photography is an exciting field that involves an education founded in conceptual as well as technical aspects. The development of the visual mind and a technical foundation in both traditional and digital imaging are the goals of the study of photography here at Victor Valley College.

Career Opportunities

Aerial Surveying, Advertising, Architectural Design, Art, Digital Imaging, Fashion, Film Maker, Forensic and Criminal Applications, Marine Biology, Photo Finishing, Portrait Photography, Product Photography, Photographer's Assistant Sports, Teaching

Faculty

Frank Foster

Degrees and Certificates Awarded

Associate in Arts, Fine Arts
Photography Certificate

Associate Degree

No associate degree offered with a major in Photography. Photography courses may be used to fulfill requirements for an Associate in Arts degree with a major in Fine Arts. See specific listings for degree requirements in these majors. PHOT 138 (Cooperative Education) may be used as Elective credit, but may not be used to fulfill major requirements.

Transfer

Photography is usually a concentration or option within an Art or Applied Art major at colleges within the University of California and California State University systems. Various private or independent colleges that focus specifically on the arts offer bachelor's degrees with a major in Photography or as a concentration or option within an Art or Applied Art major.

Because the major and the general education requirements vary in this major from university to university, students interested in photography should study the catalog or website of the specific university to which they plan to transfer. Also, visit www.assist.org and, for independent schools, www.aiccu.edu.

The following is a sampling of colleges which offer Photography majors or Photography concentrations within Art or Applied Art majors:

- **California State University campuses at East Bay, Fullerton, Hayward, San Jose, San Luis Obispo**
- **University of California, Santa Cruz**
- **Art Center College of Design, Pasadena**
- **California College of Arts and Crafts, Oakland**
- **California Institute of the Arts, Valencia**
- **Chapman University**

PHOTOGRAPHY CERTIFICATE OF CAREER PREPARATION

Prepares the student for a variety of employment opportunities within the photographic field. This certificate also provides an opportunity for the student to continue on toward a more advanced certificate program. The student will be exposed to portrait, industrial, commercial, and architectural photography. An emphasis will be placed on learning Adobe Photoshop, digital cameras and digital output devices. The proper use of light will also be extensively covered. All camera formats will be covered.

Units Required: 17.0

All of the following must be completed:

PHOT 100	Beginning Photography	3.0
PHOT 101	Intermediate Photography	3.0
PHOT 105	Portraiture	3.0
PHOT 52	Introduction to Photoshop	3.0
PHOT 53	Lighting Techniques	3.0
PHOT 54	Portfolio Design	2.0

Photography Courses

PHOT 50 COMMERCIAL PHOTOGRAPHIC APPLICATION

Units: 3.0 | **32-36 hours lecture and 48-54 hours laboratory**

(No prerequisite. Recommended preparation: PHOT 100 and PHOT 101)

This course will introduce the application of photo-graphic imaging to the commercial marketplace. It will stress the use of photography as it applies to the graphic design field as well as portraiture, product and editorial applications. Business principles of this field will also be covered.

PHOT 51 ENVIRONMENTAL PHOTOGRAPHY

Units: 3.0 | **32-36 hours lecture and 48-54 hours laboratory**

(No prerequisite. Recommended preparation: PHOT 100 and PHOT 101)

This course will cover basic camera exposure and composition for a variety of outdoor settings. Topics include: landscape photography, animal photography, flower photography, sports photography, macro photography and outdoor portraits. The uses and understanding of filters, flash and film. Some field trips will be required.

PHOT 52 INTRODUCTION TO PHOTOSHOP

Units: 3.0 | **32-36 hours lecture and 48-54 hours laboratory**

(No prerequisite)

This course will introduce the basics of Adobe PhotoShop and its application to digital photography utilizing the Macintosh and PC platforms.

PHOT 53 LIGHTING TECHNIQUES

Units: 3.0 | **32-36 hours lecture and 48-54 hours laboratory**

(No prerequisite. PHOT 100, PHOT 101, or equivalent experience recommended.)

This course will introduce the student to the fundamentals of lighting and its application to imaging processes. A broad range of topics will be covered that include portraiture, product and commercial applications.

PHOT 54 PORTFOLIO DESIGN

Units: 2.0 | **24-27 hours lecture and 24-27 hours laboratory**

(No prerequisite. PHOT 100 and PHOT 101 recommended.)

This course will present visual problems for the student to solve for the purpose of creating a traditional and digital portfolio.

PHOT 100 BEGINNING PHOTOGRAPHY

Units: 3.0 | **CSU, UC** | **32-36 hours lecture and 48-54 hours laboratory**

(No prerequisite. Grade Option)

This is a course that introduces the basics of black and white photography. Technical and conceptual topics will be covered. Students will furnish their own cameras with manual controls.

PHOT 101 INTERMEDIATE PHOTOGRAPHY

Units: 3.0 | **CSU, UC** | **32-36 hours lecture and 48-54 hours laboratory**

(No prerequisite. PHOT 100 is recommended. Grade Option)

This is an intermediate course designed to teach the student how to use film and digital cameras. Topics covered in this course will be intermediate techniques of photography such as an introduction to portraiture, lighting techniques, multiple light portrait photography, infrared techniques and the view camera. An introduction to Adobe Photoshop will also be covered. This course can be completed with film or digital cameras.

Photography Courses

PHOT 103 ALTERNATIVE IMAGING PROCESS

Units: 3.0 [CSU](#) | 32-36 hours lecture and 48-54 hours laboratory

(No prerequisite. PHOT 100 or equivalent recommended. Grade Option)

This course will cover a variety of alternative 19th century photographic processes such as cyanotype, Van Dyke, hand-coloring and toning using traditional techniques as well as computer generated images. Plastic cameras and their use in creative image creation will be covered. Applying creative textures and borders will also be covered. Anyone with a high interest in creative image production should take this course. Each student will supply his or her own camera.

PHOT 105 PORTRAITURE

Units: 3.0 [CSU](#) | 32-36 hours lecture and 48-54 hours laboratory

(No prerequisite. Recommended preparation: PHOT 100 and PHOT 101.)

This course will cover studio and outdoor portrait techniques, flash fill techniques as well as elements of commercial photography. This course may be completed with digital or film based cameras. Student must supply a DSLR camera or a 35mm manual film based camera.

PHOT 106 INTRODUCTION TO PHOTOJOURNALISM

Units: 2.0 [CSU](#) | 96-108 hours laboratory

(No prerequisite.)

This lab class is an introduction to the basics of photojournalism including basic photography skills, digital imaging, processing, composition, and production of written news stories. See cross-listing for JOUR 106.

PHOT 110 INTERMEDIATE PHOTOSHOP

Units: 3.0 [CSU](#) | 32-36 hours lecture and 48-54 hours laboratory

(No prerequisite.)

This course will introduce intermediate techniques of Adobe Photoshop and its application to digital media.

PHOT 111 BEGINNING DIGITAL PHOTOGRAPHY

Units: 3.0 [CSU](#) | 32-36 hours lecture and 48-54 hours laboratory

(No prerequisite.)

This beginning digital photography course will cover imaging basics such as exposure control using shutter speeds and apertures, composition and lighting. Topics include the integration of traditional design, color and compositional principles utilizing contemporary digital methods and tools. This course will also use the computer to further manipulate digital images. The controls of digital cameras, scanning, editing, output and image enhancement will be covered.

PHOT 115 HISTORY OF STILL PHOTOGRAPHY

Units: 3.0 [CSU,UC](#) | 48-54 hours lecture

(No prerequisite. Grade Option)

This course surveys the history and development of photography across the globe from its inception to the present. Photographic works are investigated in relation to art history, cultural history and social history. This course ends with a consideration of photography in the digital age.

PHOT 129 INDEPENDENT STUDY

See Independent Study listing (1-3 units). [CSU](#)

PHOT 138 COOPERATIVE EDUCATION

See Cooperative Education listing (1-8 units). [CSU](#)

Physical Sciences

General Physical Sciences includes a number of scientific courses which often encompass a number of related disciplines. They are intended to serve as introductory level general education courses while also providing a basis for future, more advanced study in each of their respective fields.

Career Opportunities (May require advanced degree)

Astronomer, Geologist, Meteorologist, Oceanographer

Degrees and Certificates Awarded

Associate in Arts, Liberal Arts

Associate in Science, Math/Science

Associate Degree

No associate degree offered with a major in Physical Sciences. Physical Science courses may be used to fulfill requirements for an Associate in Science degree with a major in Math/Science or Liberal Arts. See specific listings for requirements in these majors. PSCI 138 (Cooperative Education) may be used for elective credit, but may not be used to fulfill major requirements.

Transfer

For the most up-to-date information on this program and others, visit www.assist.org. Please stop by the Transfer Center in Building 55 or make an appointment with a counselor if you have questions.

- *University of California, Riverside: Physical Sciences major*

Physical Sciences Courses

PSCI 101 PRINCIPLES OF PHYSICAL SCIENCE

Units: 3.0 **CSU, UC** | 48-54 hours lecture

(UC credit limitation) (No prerequisite)

A general education course dealing with basic concepts of the physical sciences including astronomy, geology, meteorology, and oceanography.

PSCI 128 SPECIAL TOPICS

See Special Topics listing (Variable units). **CSU**.

PSCI 138 COOPERATIVE EDUCATION

See Cooperative Education listing (1-8 units). **CSU**

Physics

The study of physics involves trying to understand, at the most fundamental level, our observations of natural phenomena. Inquiries extend from the most minute of subatomic particles, to nuclei, atoms, molecules, solids, liquids, gases and plasmas, stars and galaxies. Physics seeks to explain how, under the influence of some fundamental forces, nature behaves as it does. In a larger sense it tries to address questions about our universe, such as: Where did we come from? What will be our ultimate fate?

The sequence of physics classes fills the lower division requirements for students who plan to major in fields such as physics, engineering or medicine.

Career Opportunities (May require advanced degree)

Engineer, Physicist, Teaching at many levels

Faculty

Michael Butros

Degrees and Certificates Awarded

Associate in Arts, Liberal Arts
Associate in Science, Math/Science

Associate Degree

No associate degree offered with a major in Physics. Physics courses may be used to fulfill requirements for an Associate in Science degree with a major in Math/Science or Liberal Arts. See specific listings for requirements in these majors. PHYS 138 (Cooperative Education) may be used as Elective credits, but may not be used to fulfill major requirements.

Transfer

For the most up-to-date information on these programs and others, visit www.assist.org. Please stop by the Transfer Center in Building 55 or make an appointment with a counselor if you have questions.

- **California State University, San Bernardino:** Physics major
- **University of California, Riverside:** Physics major

Physics Courses

PHYS 100 INTRODUCTORY PHYSICS

Units: 4.0 **CSU, UC** | 48-54 hours lecture and 48-54 hours laboratory

(UC credit limitation) (Prerequisite: MATH 42 minimum grade C.)

An introduction to general physics for students who have not had physics, or who have not had physics recently. Fundamental principles of mechanics, waves, heat, electricity and magnetism, light, atomic and nuclear physics.

PHYS 128 SPECIAL TOPICS

See Special Topics listing (Variable units). **CSU**.

PHYS 129 INDEPENDENT STUDY

See Independent Study listing (1-3 units). **CSU**

PHYS 138 COOPERATIVE EDUCATION

See Cooperative Education listing (1-8 units). **CSU**

PHYS 201 ENGINEERING PHYSICS I - MECHANICS

Units: 4.0 **CSU, UC** | 48-54 hours lecture and 48-54 hours laboratory

(UC credit limitation) (Prerequisite/Co-requisite: MATH 226/226H minimum grade of C.)

Course covers a study of vectors, rectilinear motion, motion in a plane, particle dynamics, work and energy, conservation laws, collisions, rotational kinematics and dynamics.

PHYS 202 ENGINEERING PHYSICS II – FLUIDS, SOUND AND THERMODYNAMICS

Units: 4.0 **CSU, UC** | **48-54 hours lecture and 48-54 hours laboratory**

(UC credit limitation) (Prerequisite: PHYS 201 minimum grade C and Prerequisite/Co-requisite: MATH 227/ 227H.)

Course covers the study of equilibrium of rigid bodies, oscillations, gravitation, fluid statics and dynamics, waves in elastic media, sound, and thermodynamics.

PHYS 203 ENGINEERING PHYSICS III - ELECTRICITY AND MAGNETISM

Units: 4.0 **CSU, UC** | **48-54 hours lecture and 48-54 hours laboratory**

(UC credit limitation). (Prerequisite: PHYS 202 minimum grade C and Prerequisite/Co-requisite: MATH 228/ 228H.)

Course covers charge and electric force, the electric field, electric potential, capacitors and dielectrics, direct current and resistance, electromotive force and circuits, the magnetic field, inductance, magnetic properties of matter, electromagnetic oscillations, alternating currents, electromagnetic waves, and the Maxwell Equations.

PHYS 204 ENGINEERING PHYSICS IV – OPTICS AND MODERN PHYSICS

Units: 4.0 **CSU, UC** | **48-54 hours lecture and 48-54 hours laboratory**

(UC credit limitation) (Prerequisite: PHYS 203 minimum grade C.)

Course covers the nature and propagation of light, reflection and refraction, interference, diffraction, gratings and spectra, relativity, elements of quantum physics, waves and particles, nuclear physics.

PHYS 221 GENERAL PHYSICS I

Units: 4.0 **CSU, UC** | **48-54 hours lecture and 48-54 hours laboratory**

(UC credit limitation) (Prerequisite: MATH 104 minimum grade C and Prerequisite/Co-requisite: MATH 226/ 226H. Recommended preparation: PHYS 100.)

Course covers vectors, motion in one and two dimensions, particle dynamics, work and energy, conservation laws, collisions, rotational motion and dynamics, thermodynamics.

PHYS 222 GENERAL PHYSICS II

Units: 4.0 **CSU, UC** | **48-54 hours lecture and 48-54 hours laboratory**

(UC credit limitation) (Prerequisite: PHYS 221 minimum grade C and Prerequisite/Co-requisite: MATH 227/ 227H. Recommended preparation: PHYS 100.)

Course covers electromagnetic theory, oscillations, waves, geometrical optics, interference and diffraction quantum physics, atomic and nuclear physics.

PHYS 230 STATICS

Units: 3.0 **CSU, UC** | **48-54 hours lecture**

(Prerequisite: PHYS 201, and MATH 227 or 227H with a grade of "C" or better.)

This class is concerned with the analysis of forces on physical systems in static equilibrium. Topics covered include:

- *Force and moment vectors, resultants. *Principles of statics and free-body diagrams.
- *Applications to simple trusses, frames, and machines. *Distributed loads.
- *Internal forces in beams. *Properties of areas, second moments. *Laws of friction.

Political Science

Political science is the study of political philosophies, processes, principles, and the structures of government and other political institutions. This academic discipline leads toward an understanding of the institutions of political ideologies, institutions of government, the roles of citizens and political leaders, interest groups and political parties, the electoral process, and con-temporary issues that surround our public life. This field also includes an analysis of governments around the world and of international relations.

Career Opportunities

Attorney, Budget Analyst, Campaign Consultant/Staff Member, Educator, Foreign Diplomat/International Organization Worker, Government Official/Elected Official, Intelligence Officers & Analysts, Law Enforcement Officer Legislative/Executive Staff Assistant, Lobbyist, National/International Business Position, Nonprofit Organization Staff Member, Print/Broadcast Journalist, Political Party Worker, Urban Planner/City Manager

Faculty

Dino Bozonelos | David Dupree

Degrees and Certificates Awarded

Associate in Arts for Transfer, Political Science
International Studies Certificate

The Political Science Department also offers a certificate in Paralegal Studies. See Paralegal Studies for further information about this program of study.

Program Learning Outcomes

A student receiving a degree or certificate in this field will be able to:

- Demonstrate a breadth of knowledge and critical thinking skills as related to political theory, institutional politics and political behavior
- Analyze political and social issues within a wide variety of assigned formats
- Recognize the relationships among political actors within political systems and the political processes for policy development

Associate Degree

Some Political Science courses may be used to fulfill requirements for an Associate in Arts degree with a major in Liberal Arts. See specific listing for requirements in that major. Also see Administration of Justice.

To earn an Associate in Arts degree for Transfer with a major in Political Science, complete the required major courses and all other requirements specified on the following pages (i.e. 60 CSU transferable units, CSU GE or IGETC, etc.). For more information on the AA-T/AS-T degrees, meet with a counselor or www.adegreewithaguarantee.com

Transfer

For the most up-to-date information on these programs and others, visit www.assist.org. Please stop by the Transfer Center in Building 55 or make an appointment with a counselor if you have questions.

- **California State University, San Bernardino:** Political Science major
- **University of California, Riverside:** Political Science major

Political Science, AA-T (33022)		
<p>Political science is the study of political philosophies, processes, principles, and the structures of government and other political institutions. This academic discipline leads toward an understanding of the approaches to the study in the field of political science, political ideologies, institutions of government, the roles of citizens and political leaders, interest groups and political parties, the electoral process, and contemporary issues that surround our public life. This field also includes an analysis of governments around the world and of international relations.</p> <p>The Associate in Arts in Political Science for Transfer degree is aligned with the Transfer Model Curriculum (TMC) for Political Science. The goal of the degree is to prepare students for transfer to the California State University system. It is specifically designed to fulfill the lower division requirements for the Baccalaureate degree in Political Science at a California State University. Students should consult with a counselor to determine whether this degree is the best option for their transfer goals.</p>		
Program Requirements: 18-19 units		
Required Courses (3 units total)		
POLS 102/H102	Introduction to American Government and Politics	3.0
Additional Courses		
List A – Select THREE of the following courses (9-10 units)		
POLS 101	Introduction to Political Science	3.0
POLS 110	Contemporary World Affairs	3.0
POLS 112	Comparative Government	3.0
POLS 114	Political Philosophy	3.0
MATH 120/H120	Introduction to Statistics	4.0
List B – Select TWO (6 units)		
POLS 103	American State and Local Government	3.0
POLS 113	Politics of the Middle East and North Africa	3.0
POLS 206	Introduction to Environmental Policy and Natural Resource Management	3.0
POLS 211	Global Issues	3.0
ECON 101	Principles of Economics: Macro	3.0
<p>A student wishing to pursue an AA-T/AS-T degree in the major listed on this page must ensure the CSU of their choice is accepting that similar major. Students completing an AA-T/AS-T degree are guaranteed admissions into a CSU campus given that a student fulfills the following:</p> <ol style="list-style-type: none"> 1) 60 CSU transferable units; 2) Completes the CSU General Education (GE) or IGETC General Education pattern; 3) Completes the major requirements for the AA-T/AS-T; 4) Maintains a transferable cumulative GPA of at least 2.0 (C or better); 5) Completes the basic/Golden 4 GE requirements. <p>For more information on the AA-T/AS-T degrees, meet with a counselor or visit www.adegreewithaguarantee.com</p>		

Political Science

INTERNATIONAL STUDIES CERTIFICATE OF CAREER PREPARATION

The International Studies Certificate program at Victor Valley College is designed for students pursuing careers in International affairs. Career Opportunities include: Foreign Diplomat, Homeland Security Analyst, Intelligence Officers & Analysts, International Organization Worker, and International Business Positions.

Units Required: 15-17.0

Group I – All of the following must be completed:

POLS 104	Introduction to Global Studies	3.0
POLS 110	Contemporary World Affairs	3.0
POLS 112	Comparative Government	3.0
POLS 113	Politics of the Middle East & North Africa	3.0

Group II – One of the following must be completed:

ANTH 102	Cultural Anthropology	3.0
CMST 105	Intercultural Communication	3.0
FREN 101	Elementary French	5.0
GEOG 102	Cultural Geography	3.0
HIST 104	World History Since 1500	3.0
HIST 131	Latin American History	3.0
POLS 211	Global Issues	3.0
POLS 221	Model United Nations	3.0
RLST 110	World Religions	3.0
SPAN 101	Elementary Spanish	5.0
SPAN 101A	Fundamentals of Spanish 101A	3.0
SPAN 125	Conversational Spanish	3.0

POLS 101 INTRODUCTION TO POLITICAL SCIENCE

Units: 3.0 **CSU, UC** | **48-54 hours lecture**

(No prerequisite. Recommended preparation: Eligibility for ENGL 50)

An introduction to modern politics and the scope of political science as a discipline. Presents a comprehensive survey of the study of political science, modern political ideologies and movements, participation, institutions of government, political issues and foreign affairs of nation-states around the world.

POLS 102 INTRODUCTION TO AMERICAN GOVERNMENT AND POLITICS

Units: 3.0 **CSU, UC** | **48-54 hours lecture**

(UC credit limitation) (No prerequisite. Recommended preparation: ENGL 50 or eligibility for ENGL 101.0 or ENGL 101H.)

Examines the workings of our complex system of American government, including: national, California state, and local levels (with emphasis on the national level). This survey will focus on the historical and contemporary development of our Constitution, political institutions, citizen participation, politics, and policies. Examines the causes, consequences, and possible solutions to significant problems in contemporary America.

POLS 102H HONORS AMERICAN GOVERNMENT AND POLITICS

Units: 3.0 **CSU, UC** | **48-54 hours lecture**

(UC credit limitation). (Prerequisite: ENGL 101.0 or ENGL 101H minimum grade B)

Enhanced for honors students. This course is an introductory survey of American governing institutions, federal and state, and other elements of the political system. The course is issue-oriented, inviting students to analyze critically competing theories and arguments relating to the founding of the Republic (especially the development of the Constitution), federalism, individual rights and liberties, interest groups, political parties, voting behavior and elections, campaign finance reform, public policy options, and the operational relations among the executive, legislative, and judicial branches. Course curriculum recognizes the roles and contributions of racial and ethnic groups and women in American politics. On each of these topics comparisons will be made to the governing units and politics of California, as well as local government.

POLS 103 STATE AND LOCAL GOVERNMENT

Units: 3.0 **CSU** | **48-54 hours lecture**

(No prerequisite. Recommended preparation: ENGL 50 or eligibility for ENGL 101.0 or ENGL 101H.)

An introduction to the study of the American political system at the state and local levels of government. Examines the workings of our complex system of federalism by focusing on contemporary state and local government institutions, citizen participation, political problems, politics, and policies. Emphasis is given to the analysis of California political issues, politics and government.

POLS 104 INTRODUCTION TO GLOBAL STUDIES

Units: 3.0 **CSU, UC** | **48-54 hours lecture**

(No prerequisite)

A survey of the historical and cultural processes that have made the world more interconnected. This course will canvass the "great ideas" that have connected human civilizations and the processes which have initiated and continued the process of globalization. Topics include the cultural, economic, historical, political and religious effects of globalization.

POLS 110 CONTEMPORARY WORLD AFFAIRS

Units: 3.0 **CSU, UC** | **48-54 hours lecture**

(No prerequisite)

An introduction to the analysis of the historical development and contemporary setting of political relations between and among nation-states, trans-national movements, and international organizations. Introduces the analytical approaches to the study of world affairs and theories of international conflict and cooperation. Explores the variety of governmental and non-governmental entities on the world stage today, their foreign policy goals and interests, and instruments and uses of power. Examines contemporary issues confronting the global community and the historical development and uses of international law and organizations.

Political Science Courses

POLS 112 COMPARATIVE GOVERNMENT

Units: 3.0 **CSU, UC** | 48-54 hours lecture

(No prerequisite)

A comparative study of the development, organization and principles of a number of foreign governments. The international community will be discussed in four broad categories on a continuum from political instability to political stability. Specific focus upon the German, Russian, French, and British governments.

POLS 113 POLITICS OF THE MIDDLE EAST & NORTH AFRICA

Units: 3.0 **CSU, UC** | 48-54 hours lecture

(No prerequisite. Grade option)

This course will examine the Middle East and North Africa through a comparative politics perspective. This will include an examination of the following items: an overview of the region's histories, geographies, peoples, cultures, religions and languages; the fundamentals of the Islamic and Judaic belief systems; current events such as the Israeli-Palestinian conflict, the War in Iraq and other real potential geopolitical conflicts.

POLS 114 POLITICAL PHILOSOPHY

Units: 3.0 **CSU, UC** | 48-54 hours lecture

(Recommended Preparation: ENGL 101.0)

Introduction to the normative discussion of social organization from a variety of philosophical perspectives. Topics include the nature of the state, rights, the role of law, liberty, distributive justice, and the common good. Emphasis on the American social experience with additional attention given to the global context

POLS 128 SPECIAL TOPICS

See Special Topics listing (Variable units) **CSU**

POLS 129 INDEPENDENT STUDY

See Independent Study listing (1-3 units) **CSU**

POLS 138 COOPERATIVE EDUCATION

See Cooperative Education listing (1-8 units) **CSU**

POLS 206 INTRODUCTION TO ENVIRONMENTAL POLICY AND NATURAL RESOURCE MANAGEMENT

Units: 3.0 **CSU, UC** | 48-54 hours lecture

(No prerequisite)

This course examines American environmental policy and how natural resources are managed. The historical, global, and ethical dimensions of how our society relates to the environment are analyzed from an interdisciplinary perspective.

POLS 211 GLOBAL ISSUE

Units: 3.0 **CSU, UC** | 48-54 hours lecture

(No prerequisite. Grade Option)

Surveys recent developments in the nature of global interdependence. Examines the major political, economic, and military conflicts of this century and recent problems of population growth, environmental decay, ethnic/national antagonism and violence, and post-Cold War politics. Course content changes based on current events.

POLS 221 MODEL UNITED NATIONS

Units: 3.0 **CSU** | 48-54 hours lecture

(No prerequisite. This course may be taken four times)

The course introduces students to the theory and practice of international diplomacy through participation in Model United Nations simulations. The course focuses on the history, structure, and functions of the United Nations; international bargaining and diplomacy; conflict resolution; researching and writing position papers and resolutions; and public speaking. Students are not required to attend a Model United Nations Conference.

Psychology

Psychology is a behavioral science that has as its goals to describe, understand, explain, predict and influence behavior and mental processes. Graduates in psychology—bachelor’s degree and post-graduate study are employed in a number of areas, including education, research, clinical practice, government, and business. Some of the major sub-fields in psychology are clinical, developmental, educational, environmental, health, industrial/organizational, neuropsychology, school, and social psychology.

Career Opportunities

Academic Counselor, Education, Educational Psychologist, Industrial/Organizational Psychologist, Licensed Marriage and Family Therapist, Licensed Professional Clinical Counselor, Mental Health Officer, Human Resources, Probation Officer, Psychologist, Rehabilitation Counselor, Social Worker

Faculty

April Garcia, MA, BCBA | Robert Flome, MS, LMFT | Patricia Jennings, MA, LMFT
Jim Previte, MA - Emeritus | Bill Bachofner, MA - Emeritus

Degrees and Certificates Awarded

Associate in Arts for Transfer, Psychology

Program Learning Outcomes

A student receiving a degree or certificate in this field will be able to:

- Demonstrate a breadth of knowledge and critical thinking skills as related to human behavior and mental processes
- Apply the scientific method to distinguish science from pseudoscience as it relates to behavior and mental preferences.
- Communicate scientifically to peers and to the community

Certificate Program

No certificates awarded. See Alcohol and Drug Studies for certificates offered at surrounding community colleges.

Associate Degree

To earn an Associate in Arts degree for Transfer with a major in Psychology, complete the required major courses and all other requirements specified on the following pages (i.e. 60 CSU transferable units, CSU GE or IGETC, etc.). For more information on the AA-T/AS-T degrees, meet with a counselor or www.adegreewithaguarantee.com

Transfer

For the most up-to-date information on these programs and others, visit www.assist.org. Please stop by the Transfer Center in Building 55 or make an appointment with a counselor if you have questions.

- **California State University, San Bernardino:** Psychology major
- **University of California, Riverside:** Psychology major | Psychobiology major

Local Bachelors Program

For information on the following program located in the High Desert, please visit: www.vvc.edu/offices/transfer-center and select “Counseling Information Sheets”:

- **Brandman University, Victor Valley Campus:** Psychology major

Psychology

Psychology, AA-T (33026)

Psychology offers much to the student who desires to study and understand the complexity of behavior and mental processes. The Associate in Arts in Psychology for Transfer program allows the student to utilize research methods, evaluate the credibility of research, theories, and applications; understand the core fields, paradigms, and theories; apply psychological concepts, theoretical perspectives, empirical findings, and historical trends to questions and issues in personal experience and contemporary society; and understand the ethical standards in academic and applied psychology. The Associate in Arts in Psychology for Transfer degree program also provides students with the opportunity to learn to describe, explain, predict, and influence behavior, in various situations, because it is one of a few disciplines with a broad and relevant scope.

Associate in Arts in Psychology for Transfer degree is to prepare students for transfer to the California State University system to complete the Baccalaureate degree in Psychology. Students should consult with a counselor to determine whether this degree is the best option for their transfer goals.

Program Requirements: 19 units

Required Courses (10 units total)

MATH 120/H120	Introduction to Statistics	4.0
PSYC 101	Introductory Psychology	3.0
PSYC 102	Research Methods for Behavioral Sciences	3.0

Additional Courses

List A –(3 units total)

PSYC 109	Biopsychology	3.0
----------	---------------	-----

List B – Select ONE (3 units)

PSYC 110	Developmental Psychology	3.0
PSYC 111	Introduction to Child Psychology	3.0

List C – Select ONE (3 units)

PSYC 108	Family Dynamics of Addiction and Abuse	3.0
PSYC 121	Human Sexuality and Intimacy	3.0
PSYC 125	Introduction to Counseling	3.0
PSYC 133	Introduction to Substance Abuse Studies	3.0
PSYC 204	Social Psychology	3.0
SOC 101	Intro to Sociology	3.0

A student wishing to pursue an AA-T/AS-T degree in the major listed on this page must ensure the CSU of their choice is accepting that similar major. Students completing an AA-T/AS-T degree are guaranteed admissions into a CSU campus given that a student fulfills the following:

- 1) 60 CSU transferable units;
- 2) Completes the CSU General Education (GE) or IGETC General Education pattern;
- 3) Completes the major requirements for the AA-T/AS-T;
- 4) Maintains a transferable cumulative GPA of at least 2.0 (C or better);
- 5) Completes the basic/Golden 4 GE requirements.

For more information on the AA-T/AS-T degrees, meet with a counselor or visit www.sb1440.org and www.adegreewithaguarantee.com

PSYC 51 PEER TUTORING FUNDAMENTALS

Units: 1.0 | 16-18 hours lecture

(No prerequisite.)

PSYC 51 is designed to teach potential tutors to learn and practice the skills tutors need to work with students in one-on-one and group situations. The primary goal for a tutor is not to teach but to assist the student in learning course content and study skills/habits biological and neurological basis of behavior.

PSYC 101 INTRODUCTORY PSYCHOLOGY

Units: 3.0 | CSU, UC | 48-54 hours lecture

(No prerequisite. Recommended preparation: Eligibility for ENGL 101.0 or ENGL 101H)

This course provides instruction in the nature of human behavior and a consideration of theories and principles pertaining to the topics of research design and experimentation, perception, emotions and motivation, personality, social psychology, psychopathology, human development, learning, cognition and memory. It includes essential features of the biological and neurological basis of behavior.

PSYC 102 RESEARCH METHODS FOR BEHAVIORAL SCIENCES

Units: 3.0 | CSU, UC | 32-36 hours lecture 48-54 hours laboratory

(Prerequisite: PSYC 101 or PSYC 101H; MATH 120 or MATH 120H. Recommended preparation: Eligibility for ENGL 101.0 or ENGL 101H)

This course is designed to introduce students to the basic assumptions of the scientific method and principles of research methods for the behavioral sciences. Psychological and social research methods examined may include experimental research, survey research, field research, correlations and comparative-historical research. Procedures to evaluate the soundness of research designs and ethical issues related to research designs and methodologies are also considered.

PSYC 108 FAMILY DYNAMICS OF ADDICTION AND ABUSE

Units: 3.0 | CSU | 48-54 hours lecture

(No prerequisite)

This course studies family abuse and addiction. Theories and evidence-based intervention strategies that promote behavioral change and wellness are evaluated. Chemical, child, spousal, and dependent adult abuse are defined within a social, cultural, and historical context. It also explores the correlation between chemical dependency and family dysfunction as well as the developmental impact abuse has on children and adolescents.

PSYC 109 BIOPSYCHOLOGY

Units: 3.0 | CSU, UC | 48-54 hours lecture

(Prerequisite: PSYC 101 or PSYC 101H)

Introduction to the study of behavior from a biological perspective. Neuroanatomy, neurophysiology, psychopharmacology, and the biological systems and processes underlying behavior. Emphasis will be placed on brain mechanisms underlying behavior and their relation to issues in psychology.

PSYC 110 DEVELOPMENTAL PSYCHOLOGY

Units: 3.0 | CSU, UC | 48-54 hours lecture

(UC credit limitation) (No prerequisite. Recommended preparation: Eligibility for ENGL 101.0 or ENGL 101H and satisfactory completion of PSYC 101.)

This course includes the study of the theories, methods, and research findings regarding biosocial, cognitive, and psychosocial development of the individual from conception through adulthood, including death, dying, and bereavement.

PSYC 111 INTRODUCTION TO CHILD PSYCHOLOGY

Units: 3.0 | CSU, UC | 48-54 hours lecture

(UC credit limitation). (No prerequisite. Recommended preparation: Eligibility for ENGL 101.0 or ENGL 101H.)

This course is a survey of the psychological growth of the normal individual from conception through adolescence. Particular emphasis is given to biopsychosocial, emotional, and cognitive development. Other topics include parenting styles and the potential problems encountered by children and adolescents.

Psychology Courses

PSYC 121 HUMAN SEXUALITY AND INTIMACY

Units: 3.0 CSU, UC | 48-54 hours lecture

(No prerequisite)

This is a survey course of human sexual and intimate behaviors throughout the life cycle. It includes the physiological, psychological, sociological, and theoretical approaches of human sexuality, the cultural legacy of human sexuality, variations of sexual behaviors and intimate relationships, sexuality throughout the life cycle, sexual disorders and related social issues.

PSYC 125 INTRODUCTION TO COUNSELING

Units: 3.0 CSU | 48-54 hours lecture

(No prerequisite. Recommended preparation: PSYC 101)

An introduction to principles and practices of counseling concepts will be the primary focus. A systematic consideration of the basic skills and theories essential for effective counseling and problem solving.

PSYC 128 SPECIAL TOPICS

See Special Topics listing (Variable units) CSU

PSYC 129 INDEPENDENT STUDY

See Independent Study listing (1-3 units) CSU

PSYC 133 INTRODUCTION TO SUBSTANCE ABUSE STUDIES

Units: 3.0 CSU, UC | 48-54 hours lecture

(UC credit limitation) (No prerequisite)

This course will provide a historical perspective on drug/alcohol abuse, its impact on the individual, the family, the community and society. Definitions of use, abuse, and addiction will be presented as well as the disease concept of addiction. The effectiveness and economics of various models of treatment and rehabilitation will be explored.

PSYC 138 COOPERATIVE EDUCATION

See Cooperative Education listing (1-8 units)

PSYC 204 SOCIAL PSYCHOLOGY

Units: 3.0 CSU, UC | 48-54 hours lecture

(Prerequisite: PSYC 101 or PSYC H101)

The focus of this course is the relationship between the individual and society including such topics as social identity, conformity, obedience and deviance, attitudes and attitude change, attribution theory, persuasion, prejudice and stereotyping, aggression and prosocial behavior, interpersonal relationships, group dynamics, and conflict and conflict resolution.

PSYC 206 PSYCHOSOCIAL REHABILITATION AND RECOVERY

Units: 3.0 CSU | 48-54 hours lecture

(Prerequisite: PSYC 101. Recommended Preparation: ENGL 101)

This course is an overview of the field of psychosocial rehabilitation (PSR). The course will explore the principles and values of PSR with an emphasis on person-centered treatment, consumer empowerment, and recovery. It will survey a history of psychiatric disorders and treatments, practice models, current issues facing the psychosocial rehabilitation practitioner, co-occurring disorders, consumer support systems, social services, and community resources.

PSYC 209 DEVELOPMENTAL PSYCHOPATHOLOGY

Units: 3.0 CSU | 48-54 hours lecture

(Prerequisite: PSYC 101 with a grade of "C" or better).

This course studies childhood and adolescent psychological disorders within the context of human development. Emphasis is on the developmental origins and developmental consequences of biological, social, emotional, and behavioral disturbances/influences. Topics include DSM-V classification, assessment, testing, course, etiology, gender, culture, prevention, risk and treatment modalities.

PSYC 211 INTRODUCTION TO LEARNING AND BEHAVIOR ANALYSIS

Units: 3.0 CSU 48-54 hours lecture

(Prerequisite: PSYC 101 with a grade of "C" or better).

This course addresses the fundamental principles in Learning and Behavior Analysis with an emphasis on operant conditioning, applied behavior analysis, and evolutionary and biological factors. Topics include the history and basic principles of modern learning theories; methodology, measurement and quantification of behavior research, and the application of behavior analysis techniques for changing behavior.

PSYC 213 ABNORMAL PSYCHOLOGY

Units: 3.0 CSU, UC 48-54 hours lecture

(No prerequisite)

This course explores the history and classifications of psychological disorders, symptom criteria, clinical assessment, diagnosis, and the major theoretical treatment modalities. Biopsychosocial, Psychoanalytic, Cognitive-Behavioral, Sociocultural theories are emphasized. How we define, assess, treat, and study psychological disorders is the thematic focus of the course. A variety of class exercises are used to illustrate and understand the etiology, symptoms, diagnosis, and treatment of psychological disorders.

PSYC 215 INTRODUCTION TO STATISTICS FOR THE BEHAVIORAL SCIENCES

Units: 3.0 CSU, UC 48-54 hours lecture

(Prerequisite: MATH 90 with a grade of "C" or better. Recommended preparation: ENGL 101.0/101H PSYC 101 and SOC 101.)

This is an introduction to the basic statistical methods and analyses commonly used in behavioral and sociological research. Topics include: descriptive and inferential statistics including levels and types of measurement; measures of central tendency and dispersion; normal, t, and chi-square distributions; probability and hypothesis testing; measures of significance; regression and correlation; and, analysis of variance (ANOVA). Application of statistical software to social and behavioral science data required.

PSYC 217 INTRODUCTION TO RESEARCH METHODS IN PSYCHOLOGY

Units: 4.0 CSU 48-54 hours lecture and 48-54 hours laboratory

(Prerequisite: PSYC 101/101H; PSYC 215 or MATH 120/120H, with a grade of "C" or better. Recommended preparation: ENGL 101.0/101H.)

This course surveys psychological research design and methods with an emphasis on correlational relationships, experimental procedures, descriptive methods, instrumentation, data collection, statistical analysis, and interpretation. Research design and methodology will be examined through the review of scholarly journal articles. In laboratory sessions students will conduct research in psychology and/or social science. Actual data collected from research conducted during laboratory sessions will be analyzed with statistical software.

PSYC 219 FIELDWORK IN PSYCHOLOGY AND SOCIAL SCIENCES

Units: 3.0 CSU 16-18 hours lecture and 96-108 hours laboratory

(No prerequisite. Recommended preparation: PSYC 101 with a grade of "C" or better, PSYC 125, PSYC 213, requires permission from instructor AND the Psychology Department Chair.)

Fieldwork experience in Psychology and Social Science is a required course for the Mental Health Worker and the Applied Developmental Psychology Certificate(s) of Achievement. Practical experience is a major factor in professional skill development and application of research and academic knowledge. Class meetings focus on fieldwork experiences, self-care, case communication, and multi-disciplinary teamwork experiences. Students will be assigned a supervised position in a placement setting. Field placement agencies may require a TB test and/or fingerprinting. This course requires permission from the instructor AND the Psychology Department Chair.

Religious Studies

The academic study of religion is an objective, factual, interdisciplinary study of the texts, symbols, myths, rituals, ideas, and values of the world's many religious traditions. Students are encouraged to view religion multiculturally as a means of understanding more deeply the spiritual dimensions of human nature, history, and society. Study in this field prepares students for life in a multicultural society and provides practice in such valuable skills as empathetic reading and listening, critical reflection, and descriptive and analytical writing.

Career Opportunities (Most careers require a bachelor's or advanced degree.)

Chaplain, Counselor, Government Service, Nonprofit Management, Professional Religious Leader, Religious Broadcaster, Religious Business Manager, Religious Educator, Religious Journalist, Religion Publisher, Social Worker, Teacher

Faculty

Daniel Vecchio | Marc Skuster -Emeritus

Degrees and Certificates Awarded

Associate in Arts, Liberal Arts

Associate Degree

No associate degree offered with a major in Religious Studies. Religious Studies courses may be used to fulfill requirements for an Associate in Arts degree with a major in Liberal Arts. See Liberal Arts for degree requirements for this major.

Transfer

For the most up-to-date information on this program and others, visit www.assist.org. Please stop by the Transfer Center in Building 55 or make an appointment with a counselor if you have questions.

- **University of California, Riverside:** Religious Studies major

Religious Studies Courses

RLST 101 INTRODUCTION TO RELIGIOUS STUDIES

Units: 3.0 **CSU, UC** | 48-54 hours lecture

(No prerequisite. Recommended preparation: Eligibility for ENGL 101.0 is recommended.)

Introduction to the primary forms of religious experience and expression and to the structure of religious worldviews. Examples from a variety of societies and time periods introduce and illustrate such topics as religious symbols, myths, ritual, and communities, as well as alternative concepts of ultimate reality, cosmogony, theodicy, and soteriology.

RLST 105 RELIGION OF THE OLD TESTAMENT, HEBREW SCRIPTURES, AND ANCIENT NEAR EAST

Units: 3.0 **CSU, UC** | 48-54 hours lecture

(No prerequisite. Recommended preparation: ENGL 50 or eligibility for ENGL 101.0.)

Introduction to the literature and religious history of Ancient Israel and related cultures in the Ancient Near East. Study of the sources, contents, interpretation, and religious and historical significance of the Hebrew Scriptures and the Old Testament.

RLST 106 INTRODUCTION TO THE NEW TESTAMENT AND EARLY CHRISTIAN LITERATURE

Units: 3.0 **CSU, UC** | 48-54 hours lecture

(No prerequisite. Recommended preparation: ENGL 50 or eligibility for ENGL 101.0 is recommended.)

Historical introduction to Mediterranean religion and culture in late classical antiquity. Comparative literary, historical, and sociological analysis of the literature of the period, with emphasis on the New Testament and early Christian literature.

Religious Studies Courses

RLST 110 RELIGIONS OF THE MIDDLE EAST AND THE WEST

Units: 3.0 CSU, UC | 48-54 hours lecture

(No prerequisite. Recommended preparation: ENGL 50 or eligibility for ENGL 101.0 or ENGL 101H.)

Survey of the history, beliefs, and practices of the major religious traditions of the Middle East and West; prehistoric and indigenous religions, ancient Greek, Roman, Egyptian, and Mesopotamian religions, Zoroastrianism; Judaism; Christianity; Islam; and new religious movements.

RLST 111 RELIGIONS OF SOUTH AND EAST ASIA

Units: 3.0 CSU, UC | 48-54 hours lecture

(No prerequisite. Recommended preparation: ENGL 50 or eligibility for ENGL 101.0.)

Survey of the history, beliefs, and practices of the major religions of East and South Asia: Hinduism, Buddhism, Jainism, Sikhism, Confucianism, Daoism, and Shinto. Discussion of modern challenges to traditional religion and the emergence of new religious movements inspired by Asian traditions..

RLST 113 RELIGION AND SOCIETY

Units: 3.0 CSU, UC | 48-54 hours lecture

(No prerequisite. Recommended preparation: ENGL 50 or eligibility for ENGL 101.0 is recommended.)

Study of the interaction between social forces and religious belief and practice, with an emphasis on contemporary American social and religious life. Special topics include the social aspects of evangelical religion, the interaction of religion and politics, religious diversity, the relation between religion and gender, and the impact of globalization.

RLST 115 RELIGION IN AMERICA

Units: 3.0 CSU, UC | 48-54 hours lecture

(No prerequisite. Recommended preparation: ENGL 50 or eligibility for ENGL 101.0)

Historical study of religion in America. Major topics include Native American Religion, Judaism, Roman Catholicism, Protestant Christianity, African-American Religions, American sects, metaphysical and occult movements, Asian religions, and religious themes in American public life, politics, and popular culture.

RLST 117 PHILOSOPHY OF RELIGION

Units: 3.0 CSU, UC | 48-54 hours lecture

(No prerequisite. Recommended preparation: ENGL 50 or eligibility for ENGL 101.0) See cross listing for PHIL 117.

Introduction to major topics in the Philosophy of Religion: the existence and nature of God, religious experience and knowledge, and concepts of immortality and human destiny. Special attention is given to conflicts between religion and science, competing claims for religious truth, and the relevance of religion to social ethics. Three lecture hours per week.

RLST 128 SPECIAL TOPICS

See Special Topics listing (Variable units) CSU

RLST 129 INDEPENDENT STUDY

See Independent Study listing (1-3 units) CSU

RLST 207 INTRODUCTION TO CRITICAL THINKING

Units: 3.0 CSU, UC | 48-54 hours lecture

(Prerequisite: ENGL 101.0 or ENGL 101H minimum grade C.) See cross listing for PHIL 207.

Study and practice in critical thinking and advanced English composition: analysis, evaluation, and formulation of arguments; critical study of texts; and composition of critical essays. Application of critical thinking and writing skills to topics in the areas of values and religion.

Respiratory Therapy

Respiratory therapy is an allied health profession specializing in the diagnosis, treatment, and care of patients suffering from cardiopulmonary disease.

The program provides didactic instruction and supervised clinical practice in Southern California hospitals. Graduates of the VVC Respiratory Therapy Program, as a result of the education and training they receive, pass the state licensing and national registry exams at a rate much greater than the national average. The Victor Valley College Respiratory Therapy Program is accredited by the Commission on Accreditation for Respiratory Care (www.coarc.com), 1248 Harwood Road, Bedford, TX 76021-4244, (817) 283-2835.

Separate application must be made to the Respiratory Therapy Program. Seating is limited to a maximum of twenty-six students per class.

Applications are available from the Allied Health website www.vvc.edu/academic/respiratory-therapy/ or from the Counseling Department.

Pre-course requirement paid for by student: 1) National background check; 2) Titers demonstrating immunity to Tetanus, Diphtheria, Pertussis, Varicella, Mumps, Measles, Rubella; 3) Two Tuberculosis tests within 3 months of course start; 4) Physical examination by physician; and 5) Background check and drug testing the first week of the course. Please contact Respiratory Therapy program director for information and forms.

Career Opportunities

Respiratory Care Practitioner, Critical Care Specialist, Diagnostic Testing Specialist, Education, Home Care Neonatal/Pediatric Specialist, Pulmonary Rehabilitation, Research

Faculty

Traci Marin | Michael Haines

Degrees and Certificates Awarded

Associate in Science, Respiratory Therapy
Respiratory Therapy Certificate

Program Learning Outcomes

A student receiving a degree or certificate in this field will be able to:

- Demonstrate the ability to comprehend, apply, and evaluate clinical information relative to their role as an advanced-practiced therapist (Cognitive Domain)
- Demonstrate the technical proficiency in all skills necessary to fulfill the role of Registered Respiratory Therapist (Psychomotor Domain).
- Demonstrate behaviors consistent with professionalism and meet employer expectations for the Registered Respiratory Therapist (Affective Domain).

Associate Degree

To earn an Associate in Science degree with a major in Respiratory Therapy (04957), complete all requirements for the Respiratory Therapy Certificate. The Respiratory Therapy Certificate above includes all requirements for both a certificate and an Associate in Science degree in Respiratory Therapy.

Transfer

A handout with all transfer requirements for a B.S. degree in Health Care Services, Respiratory Therapy, and other related medical degrees from Loma Linda University is available in the Counseling Department, or visit www.llu.edu.

Respiratory Therapy

RESPIRATORY THERAPY, A.S. (04957) AND CERTIFICATE OF ACHIEVEMENT (20544)		
This certificate prepares the student to take the State examination to practice as an entry level practitioner and the National Examination for Advanced level practitioner.		
Units Required: 82.0		
<i>Group A: All of the following must be completed:</i>		
RSPT 50	Polysomnography I	4.0
RSPT 230	Introduction to Respiratory Therapy	3.0
RSPT 231	Basic Fundamentals of Respiratory Therapy	10.0
RSPT 232	Patient Assessment and Clinical Application of Respiratory Therapy	10.0
RSPT 233	Intensive Respiratory Care and Advanced Pulmonary Physiology	13.0
RSPT 234	Neonatal / Pediatric Respiratory Therapy Care and Related Pathophysiology	13.0
RSPT 239	Introduction to Continuous Mechanical Ventilation Support	2.0
BIOL 211	Human Anatomy	5.0
BIOL 221	General Microbiology	5.0
BIOL 231	Human Physiology	5.0
ENGL 101	English Composition and Reading	4.0
PSYC 101	Introductory Psychology	3.0
<i>Group B: One of the following must be completed:</i>		
CMST 106	Interpersonal Communication	3.0
CMST 107	Family Communication	3.0
CMST 108	Group Discussion	3.0
CMST 109	Public Speaking	3.0
One course which meets the VVC Logic/Mathematical general education requirement for Category V		
One course which meets the VVC Humanities general education requirement for Category III		
One Physical Education Course and one course which meets the VVC American Institutions general education requirement for Category IIB.		

The Respiratory Therapy Faculty accepts and operates within the framework of the philosophy and objectives of Victor Valley College.

The Associate Degree in Respiratory Therapy provides a foundation for continuing personal, professional and educational development, and includes the study of the arts, sciences and humanities. The program is designed to produce a competent, self-directed respiratory therapist who, in a variety of settings, can assume leadership in planning, providing, and evaluating respiratory care of individuals and groups; who participates in the determination of the goals of the profession; and who actively searches for knowledge in respiratory therapy and related fields essential to the development and application of scientific respiratory care.

The respiratory therapy graduate receives the Associate of Science Degree and is eligible to take the National Registry Exam for Respiratory Therapists and the entry level exam for licensure in the State of California.

In order to be admitted to the Respiratory Therapy Program, separate application must be made in addition to application to the college. The annual deadline date for submitting applications to be considered for respiratory therapy is May 15. Applications can be obtained through www.vvc.edu/academic/respiratory-therapy/ the Allied Health Office or the Counseling Department. Prerequisites: CHEM 100, BIOL 100 or 107, and MATH 90 must be completed with a grade of "C" or higher before entry into the program.

Respiratory Therapy Courses

RSPT 50 POLYSOMNOGRAPHY I

Units: 4.0 | 48-54 hours lecture and 48-54 hours laboratory

(No prerequisite)

Topics include sleep terminology, sleep structure and disorders, complete patient set-up and data acquisition. Students will also learn the basics of noninvasive treatments for certain sleep disorders.

RSPT 90 ECHOCARDIOGRAPHY 1

Units: 10.0 | 64-72 hours lecture and 288-324 hours laboratory

(Prerequisite: Acceptance into the Respiratory Therapy Program. Recommended preparation: BIOL 211, BIOL 231 and MATH 90.)

This course is designed to prepare students for an entry level career in a hospital or clinic as an echocardiographer. Topics include physics, instrumentation, cardiac anatomy and physiology, cardiac disease specific calculations, standard exam calculations and protocol.

RSPT 91 ECHOCARDIOGRAPHY 2

Units: 10.0 | 64-72 hours lecture and 288-324 hours laboratory

(No prerequisite. Recommended preparation: RSPT 90 with a grade of "C" or better.)

This course expands on echocardiography subjects presented in RSPT 90. Topics include assessment of pericardial diseases, vascular disorders, electrocardiogram (ECG) and advanced topics.

RSPT 138 COOPERATIVE EDUCATION

See Cooperative Education listing (1-8 units). [CSU](#)

RSPT 149 INDEPENDENT STUDY

See Independent Study listing (1-3 units) [CSU](#)

RSPT 221 BASIC CARDIOPULMONARY CLINICAL PRACTICUM AND CASE STUDIES

Units: 3.0 | [CSU](#) | 144-162 hours laboratory

(Prerequisite: RSPT 231 or RSPT 90)

Clinic-based practicum in which students perform a variety of cardiopulmonary assessments and therapies appropriate to their level in the respiratory therapy and echocardiography courses. Students present case studies based on patient-information gathering that include history and physical, review of systems, rationale for diagnostics and treatment, vital signs, medical history, questionnaire, scores, treatments, and study data.

RSPT 222 ADVANCE CARDIOPULMONARY CLINICAL PRACTICUM AND CASE STUDIES

Units: 3.0 | [CSU](#) | 144-162 hours laboratory

(Prerequisite: RSPT 233)

Critical care clinic-based practicum in which students perform a variety of cardiopulmonary assessments and therapies. Students present case studies based on critical care patient-information gathering that include history and physical, review of systems, rationale for diagnostics and treatment, vital signs, medical history, questionnaire, scores, treatments, and study data.

RSPT 230 INTRODUCTION TO RESPIRATORY THERAPY

Units: 3.0 | [CSU](#) | 48-54 hours lecture

(Prerequisite: Acceptance to the Respiratory Therapy Program)

This course introduces the student to respiratory therapy as a health science profession, including history, professional requirements, responsibilities, professional organizations, and credentialing of the respiratory care practitioner. Provides basic anatomy and physiology, physics and math, and basic cardio-pulmonary pathology in order to give the student a foundation of theory and application.

Respiratory Therapy Courses

RSPT 231 BASIC FUNDAMENTALS OF RESPIRATORY THERAPY

Units: 10.0 CSU | 64-72 hours lecture and 324 hours laboratory

(Prerequisite: RSPT 230 with a grade of "C" or better.)

This course continues with a more advanced discussion of medical terminology, anatomy, physiology and cardiopulmonary pathology as it relates to the clinical applications of medial gas therapy, humidity and aerosol therapy, therapeutic and diagnostic modalities, and infection control. Students will be provided with an extensive orientation to the hospital environment and the administration of basic respiratory therapy to patients.

RSPT 232 PATIENT ASSESSMENT & CLINICAL APPLICATION OF RESPIRATORY THERAPY

Units: 10.0 CSU | 64-72 hours lecture and 288-324 hours clinical

(Prerequisite: RSPT 231 with a grade of "C" or better.)

This course is a more in-depth study of the theory and application of respiratory therapy. Its content includes airway management, pulmonary assessment, advanced cardiopulmonary physiology and the pharmacology associated with pulmonary patients. The student will spend 16 hours a week in the hospital administrating respiratory modalities to patients.

RSPT 233 INTENSIVE RESPIRATORY THERAPY CARE

Units: 13.0 CSU | 64-72 hours lecture and 54 hours laboratory plus 432 hours clinical

(Prerequisite: RSPT 239, BIOL 211 or BIOL 231, with a grade of "C" or better.)

A more advanced study of the theory and application of respiratory care. The content will include: mechanical life support, cardiopulmonary physiology, equipment utilized in the critical care unit, microbiology, hematology, and advanced patient assessment.

RSPT 234 NEONATAL & PEDIATRIC RESPIRATORY THERAPY CARE AND RELATED PATHOPHYSIOLOGY

Units: 13.0 CSU | 64-72 hours lecture 48-54 hours laboratory and 384-432 hours clinical

(Prerequisite: RSPT 233 and BIOL 221 with a grade of "C" or better.)

This course is a more advanced study of the theory and application of neonatal/pediatric respiratory care. The content will include: mechanical life support, respiratory pathophysiology, equipment utilized in the NICU/PICU, microbiology, umbilical line, capillary blood samples and analysis, endotracheal intubation, and principles of PALS and NRP.

RSPT 239 INTRODUCTION TO MECHANICAL VENTILATION SUPPORT

Units: 2.0 CSU | 16-18 hours lecture and 48-54 hours laboratory

(Prerequisite: RSPT 232 with a grade of "C" or better.)

This course introduces the principles of mechanical ventilation, allows hands-on experience with current ventilators, and reinforces therapeutic care.

RSPT 243 CLINICAL SIMULATION

Units: 1.0 CSU | 16-18 hours lecture

(Prerequisite: RSPT 233 minimum grade C or RCP/CRT credentials with "registry eligibility" as designated by the NBRC/RCB.)

This course will prepare individuals for the National Board of Respiratory Care's (NBRC) Written Respiratory Registry Test (WRRT) and Clinical Simulation examinations. Those already certified (Certified Respiratory Therapist) and designated registry eligible by the NBRC will be able to review, evaluate, and improve their clinical assessment, decision making, and test taking skills.

Restaurant Management

The Restaurant Management program prepares students for careers in the foodservice industry. Restaurants, hotels, clubs, colleges, retirement homes, hospitals, and industrial food service are but a few of the areas of employment options. Basic food preparation and techniques, nutrition, sanitation and safety are emphasized as the fundamentals for an education foundation of more specialized and advanced skills. Creativity, innovation, and team concepts are strongly encouraged. Skills are introduced by emphasizing hands-on, practical experience coupled with strong managerial and accounting subjects.

Locally projected casinos, hotels, and national chain restaurants in the High Desert will increase various employment opportunities to local graduates. Restaurant Management is one of the original partners with the National Restaurant Association Educational Foundation and offers students the opportunity to complete the nationally recognized ManageFirst program. This program is dedicated to the advancement of professionalism in the restaurant and food service industry through education and training. It offers students acknowledgement throughout the United States.

Career Opportunities

Assistant Manager, Banquet Manager, Catering Manager, Chef, Dietary Assistant, Dining Room Manager, Food and Beverage Director, Foodservice/Restaurant Manager, Kitchen Manager, Purchasing Agent

Faculty

Duane Buckles - Emeritus

Degrees and Certificates Awarded

Associate in Science, Restaurant Management

Restaurant Management Certificate

Program Learning Outcomes

A student receiving a degree or certificate in this field will be able to:

- Analyze and evaluate procedures for preventing food borne illnesses through the flow of food specifically: purchasing, receiving, storage, preparation and service.
- Demonstrate advanced culinary techniques for various foods and beverages in both front and back of the house.
- Demonstrate proficiency utilizing the five functions of management in the foodservice setting
- Develop measurable skill-based learning objectives in specific areas of front of the house and back of the house operations.

Associate Degree

To earn an Associate of Science degree with a major in Restaurant Management (04974), complete the Restaurant Management Certificate requirements and meet all Victor Valley College graduation requirements.

Transfer

Restaurant Management courses do not usually transfer toward a bachelor's degree program. Students who earn a certificate or degree in Restaurant Management may choose to pursue a bachelor's degree in Hospitality Management or Hotel and Restaurant Management. The following CSU campuses offer degrees in these areas: Cal Poly Pomona, CSU-Long Beach, San Diego State, San Francisco State, and San Jose State. Visit www.assist.org for major preparation requirements.

Students may also wish to explore programs at the California Culinary Academy in San Francisco, or The Culinary Institute of America in New York, which also has a Napa Valley campus (Greystroke) in St. Helena, and a campus in San Antonio, Texas. Another institution is Le Cordon Bleu College of Culinary Arts in Pasadena. These colleges specialize in preparing a student to become a chef.

Restaurant Management

RESTAURANT MANAGEMENT CERTIFICATE OF ACHIEVEMENT (20547)		
The Restaurant Management certificate program gives the student the basic skills and education to become an entry level manager in the food service industry.		
Units Required: 51.0		
<i>All of the following must be completed:</i>		
First Semester		
RMGT 81	Prep/Line Cook	3.0
RMGT 82*	Customer Service	3.0
RMGT 86*	Food Service Sanitation	3.0
RMGT 87	Prin of Prof Cooking	3.0
<i>RMGT 81 and 82 should be completed within the first semester. Each class is offered twice during the semester; it doesn't matter which class you start with as long as you complete both.</i>		
Second Semester:		
RMGT 83	Kit/Din Rm TRNG <i>and</i>	6.0
Two academics offered on a rotating basis. Completing two courses from the list below will bring your total units for the semester to 12		
Third Semester:		
RMGT 84	Kit/Din Rm TRNG <i>and</i>	6.0
Two academics offered on a rotating basis. Completing two courses from the list below will bring your total units for the semester to 12		
Fourth Semester:		
RMGT 85	Adv Restaurant Mgt <i>and</i>	6.0
Two academics offered on a rotating basis. Completing two courses from the list below will bring your total units for the semester to 12		
Summer or Winter Session:		
RMGT 120	Introduction to Nutrition	3.0
Courses offered on a rotating basis - Add two to your second, third, and fourth semesters as shown above:		
RMGT 88	Management by Menu	3.0
RMGT 89*	Purchasing for Foodservice Mgrs	3.0
RMGT 90*	Restaurant Marketing	3.0
RMGT 91*	Controlling Foodservice Costs	3.0
RMGT 93*	Human Resources Management in the Foodservice Industry	3.0
RMGT 94*	Hospitality and Restaurant Management	3.0
*Indicates ManageFirst curriculum. Individual certificates issued by the National Restaurant Association Education Foundation are available in these areas.		

Restaurant Management Courses

RMGT 1 FOOD TRAINING SERVER

Units: 4.5 | **24-27 hours lecture and 144-162 hours laboratory**

(No prerequisite. Pass/No Pass.) This course does not apply to the Associate Degree.

This course will provide the student the opportunity to meet the primary role of the server in a foodservice establishment. The responsibility to meet the customer's dining needs is emphasized while maintaining the systems of the restaurant to ensure continued high quality service to all customers and maximize profit-ability for the operation. These responsibilities are carried out through five functions which are implemented through a number of tasks.

RMGT 2 PREP/LINE COOK

Units: 4.5 | **24-27 hours lecture and 144-162 hours laboratory**

(No prerequisite. Pass/No Pass.) This course does not apply to the Associate Degree.

This course will provide the student with the basic and essential training as a prep/line cook. This training includes understanding culinary terminology, proper use of kitchen equipment and hand tools, as well as practical experience.

RMGT 3 HOST/HOSTESS

Units: 4.5 | **24-27 hours lecture and 144-162 hours laboratory**

(No prerequisite. Pass/No Pass.) This course does not apply to the Associate Degree.

This course will provide the student the opportunity to develop the skills for a host/hostess position. This includes the primary role to welcome the customer and begin the service experience in a positive way, while maintaining the systems of the restaurant to ensure continued high quality service to all customers and maximize profitability for the operation.

RMGT 4 BUSSER

Units: 4.5 | **24-27 hours lecture and 144-162 hours laboratory**

(No prerequisite. Pass/No Pass.) This course does not apply to the Associate Degree.

This course will provide the student with the basic and essential training as a busser to ensure a clean and comfortable dining environment while maintaining the systems of the restaurant to ensure high quality service to all customers and maximize profitability for the operation.

RMGT 5 CASHIER

Units: 4.5 | **24-27 hours lecture and 144-162 hours laboratory**

(No prerequisite. Pass/No Pass.) This course does not apply to the Associate Degree.

This course will provide the student with the basic and essential training as a cashier in a foodservice establishment to meet the customer's dining needs, while maintaining the systems of the restaurant to ensure continued high quality service to all customers and maximize profitability for the operation.

RMGT 6 DISHWASHER

Units: 4.5 | **24-27 hours lecture and 144-162 hours laboratory**

(No prerequisite. Pass/No Pass.) This course does not apply to the Associate Degree.

This course will provide the student with the basic and essential training as a dishwasher to secure clean and sanitary equipment used in the foodservice establishment while maintaining the systems of the restaurant to ensure high quality service and maximize profitability for the operation.

RMGT 7 BAKERY / PASTRY TRAINING

Units: 4.5 | **24-27 hours lecture and 144-162 hours laboratory**

(No prerequisite. Pass/No Pass.) This course does not apply to the Associate Degree.

This course will provide the student the opportunity to achieve maximum results in the development of baking skill and knowledge. The student will learn to produce breads of many types as well as a wide variety of desserts and pastries.

Restaurant Management Courses

RMGT 8 CATERING TRAINING

Units: 4.5 | **24-27 hours lecture and 144-162 hours laboratory**

(No prerequisite. Pass/No Pass.) This course does not apply to the Associate Degree.

This course will provide the student the opportunity to understand the concepts involved in catering for banquets. This will include the objective of meeting the client's needs while maintaining the systems of the establishment to ensure continued high quality service and maximum profitability for the operation.

RMGT 75 CREATIVE CUISINE - FISH AND SHELLFISH

Units: 2.0 | **32-36 hours lecture**

(No prerequisite)

This course will examine the professional techniques of identifying, purchasing, handling, storing and the marketing of fish and shellfish. It also includes identifying, cutting, filleting, and preparing various fish and seafood.

RMGT 76 CREATIVE CUISINE - MEATS AND POULTRY

Units: 2.0 | **32-36 hours lecture**

(No prerequisite)

This course will examine the professional techniques of identifying, purchasing, handling, and storing of various meats and poultry. It also includes identifying, cutting, filleting, and preparing various meats and poultry.

RMGT 80 OFF PREMISE CATERING

Units: 3.0 | **48-54 hours lecture**

(No prerequisite)

This is a comprehensive course covering the fundamentals of catering, sales and marketing as it pertains to catering, and production of operations. Subjects covered include corporate catering, styles of service, finance, completion of necessary forms and paperwork related to catering.

RMGT 81 PREP/LINE COOK

Units: 3.0 | **32-36 hours lecture and 48-54 hours laboratory**

(No prerequisite)

This course will provide the student with basic and essential training as a prep/line cook. This training includes understanding culinary terminology, proper use experience is gained through activities performed in the lab.

RMGT 83 KIT/DIN RM TRNG

Units: 6.0 | **32-36 hours lecture and 192-216 hours laboratory**

(Prerequisites: RMGT 81, RMGT 82, RMGT 86, RMGT 87.)

This course will instruct the student in the different positions in a kitchen and dining room in the foodservice industry. Actual hands-on experience is gained as students learn by working in a foodservice operation. Students will be required to be team leaders for beginning students in the lab.

RMGT 84 KIT/DIN RM MGT

Units: 6.0 | **32-36 hours lecture and 192-216 hours laboratory**

(Prerequisite: RMGT 83)

This course will instruct the student to manage kitchen and dining room functions in a foodservice operation. While planning, organizing, coordinating, directing and controlling a foodservice operation, students will supervise teams as part of the training.

RMGT 85 ADV RESTAURANT MGT

Units: 6.0 | **32-36 hours lecture and 192-216 hours laboratory**

(Prerequisite: RMGT 84)

This course will instruct the student to integrate concepts of management skills learned in previous courses. It introduces a more extensive range of techniques, ingredients, and recipes that all successful managers must understand relating to culinary change and innovation.

Restaurant Management Courses

RMGT 86 FOOD SERVICE SANITATION

Units: 3.0

48-54 hours lecture

(No prerequisite)

This course provides students with the knowledge to assess risks, establish policies and train employees to assure a safe and sanitary food service.

RMGT 87 PRIN OF PROF COOKING

Units: 3.0

48-54 hours lecture

(No prerequisite)

This course provides an understanding of cooking theory and develops a set of manual skills with the ability to apply these skills to a wide range of cooking styles and products.

RMGT 88 MANAGEMENT BY MENU

Units: 3.0

48-54 hours lecture

(No prerequisite)

This course will provide the student with a com-prehensive look at the menu and its uses in a foodservice operation. All aspects of menu planning from customer demographics to kitchen capabilities, to cost cards and menu analysis are discussed.

RMGT 89 PURCHASING FOR FOODSERVICE MGRS

Units: 3.0

48-54 hours lecture

(No prerequisite)

This course will introduce the student to the purchasing function in the foodservice industry. Course content will include purchasing principles and procedures including ordering, contract administration and product specifications.

RMGT 90 RESTAURANT MARKETING

Units: 3.0

48-54 hours lecture

(No prerequisite)

This course examines the concepts, principles and practices involved with marketing a foodservice operation. Students will gain an understanding of how to merchandise and market an establishment to meet the main objective of an operation.

RMGT 91 CONTROLLING FOODSERVICE COSTS

Units: 3.0

48-54 hours lecture

(No prerequisite)

This course will provide the student with the basic cost control standards utilized by foodservice operations to maintain profitability and success. Students will gain an understanding of food costs as well as labor costs and ways to ensure prosperity and increased sales for a foodservice operation.

RMGT 93 HUMAN RESOURCES MANAGEMENT IN THE FOODSERVICE INDUSTRY

Units: 3.0

48-54 hours lecture

(No prerequisite)

This course will provide the student the opportunity to explore human resources management and supervision in a food-service operation. All facets of supervision as it applies to a foodservice operation will be discussed including recruiting, selection, training and development, staffing, benefit programs as well as legal guidelines for all employees.

RMGT 94 HOSPITALITY AND RESTAURANT MANAGEMENT

Units: 3.0

48-54 hours lecture

(No prerequisite)

This course provides the student with a comprehensive focus on what hospitality managers actually do and the most important challenges facing industry leaders today. The topics include leadership and management, planning, organizing, communication and decision making, motivation and control.

Restaurant Management Courses

RMGT 120 INTRODUCTION TO NUTRITION

Units: 3.0 [CSU](#) | 48-54 hours lecture

(No prerequisite). See cross listing for CHEM 120.

This course focuses on the fundamentals of nutrition as related to the restaurant and food service industry. Course content will include the fundamentals of nutrients, understanding nutrition standards and guidelines, and eating in the United States

RMGT 138 COOPERATIVE EDUCATION

See Cooperative Education listing (1-8 units). [CSU](#)

Sociology

Sociology offers much to the student who desires to understand the web and rhythm of human behavior. From intimate, personal, and family relationships to international corporation activities; from marginality, deviance and crime to recreation, religion and medicine, few disciplines have such broad scope and relevance.

Career Opportunities (Bachelor's or advanced degree usually necessary.)

Claims Examiner, Criminologist, Educator, Employment/Personnel Specialist, Interviewer/Researcher, Law Enforcement/Probation or Corrections Officer, Public Relations Consultant, Social Worker/Counselor, Statistician/Population Analyst, Urban Planning Consultant, Youth Counselor/Recreation Specialist

Faculty

Eugene Tashima

Degrees and Certificates Awarded

Associate in Arts for Transfer, Sociology

Program Learning Outcomes

A student receiving a degree or certificate in this field will be able to:

- Identify and review sociological perspectives.
- Describe and analyze social issues and social problems.
- Recognize and utilize basic concepts in statistics
- Explain and critically evaluate aspects of human social development, social interaction, and socialization in cultures, groups and society.
- Discuss and summarize concepts of ethnicity and race, deviance, social inequality, and social stratification.

Associate Degree

To earn an Associate in Arts degree for Transfer with a major in Sociology, complete the required major courses and all other requirements specified on the following pages (i.e. 60 CSU transferable units, CSU GE or IGETC, etc.). For more information on the AA-T/AS-T degrees, meet with a counselor or www.adegreewithaguarantee.com

Transfer

For the most up-to-date information on these programs and others, visit www.assist.org. Please stop by the Transfer Center in Building 55 or make an appointment with a counselor if you have questions.

- **California State University, San Bernardino:** Sociology major
- **University of California, Riverside:** Sociology major

Local Bachelors Program

For information on the following program located in the High Desert, please visit: www.vvc.edu/offices/transfer-center and select "Counseling Information Sheets":

- **Brandman University, Victor Valley Campus:** Sociology major

Sociology, AA-T (31245)

Sociology offers much to the student who desires to understand the web and rhythm of human behavior. From intimate, personal, and family relationships to international corporation activities; from marginality, deviance and crime to recreation, religion and medicine, few disciplines have such broad scope and relevance.

Associate in Arts for transfer in Sociology fulfills the lower division requirements for the Baccalaureate degree in Sociology at a California State University. Students should consult with a counselor to determine whether this degree is the best option for their transfer goals.

Program Requirements: 19 units

Required Courses (10 units total)

SOC 101	Intro to Sociology	3.0
SOC 102	American Social Problems	3.0
MATH120/120H	Introduction to Statistics	4.0

Additional Courses

List A —Select TWO of the following courses (6 units total)

SOC 103	Marriage & Family Life	3.0
SOC 107	Ethnic Experience in American Society	3.0
AJ 127	Introduction to Criminology	3.0
PSYC 204	Social Psychology	3.0

List B – Select ONE (3 units)

ANTH 102	Introduction to Cultural Anthropology	3.0
PSYC 101/101H	Introductory Psychology	3.0

A student wishing to pursue an AA-T/AS-T degree in the major listed on this page must ensure the CSU of their choice is accepting that similar major. Students completing an AA-T/AS-T degree are guaranteed admissions into a CSU campus given that a student fulfills the following:

- 1) 60 CSU transferable units;
- 2) Completes the CSU General Education (GE) or IGETC General Education pattern;
- 3) Completes the major requirements for the AA-T/AS-T;
- 4) Maintains a transferable cumulative GPA of at least 2.0 (C or better);
- 5) Completes the basic/Golden 4 GE requirements.

For more information on the AA-T/AS-T degrees, meet with a counselor or visit www.sb1440.org and www.adegreewithaguarantee.com

Sociology Courses

SOC 101 INTRO TO SOCIOLOGY

Units: 3.0 [CSU, UC](#) | 48-54 hours lecture

(No prerequisite)

This course is a survey of the various characteristics of social life, the process of social interaction and the tools of sociological investigation. Emphasis is on culture, socialization, and basic institutions.

SOC 102 AMERICAN SOCIAL PROBLEMS

Units: 3.0 [CSU, UC](#) | 48-54 hours lecture

(No prerequisite)

This one semester survey course will focus on identification of major sociological theories, concepts, and perspectives in an analytical approach to the study of social problems in contemporary American society.

SOC 103 MARRIAGE & FAMILY LIFE

Units: 3.0 [CSU](#) | 48-54 hours lecture

(No prerequisite)

This course is a survey of analytical and theoretical concepts involved in the sociological study of courtship, marriage and family in American society.

SOC 107 THE ETHNIC EXPERIENCE IN AMERICAN SOCIETY

Units: 3.0 [CSU, UC](#) | 48-54 hours lecture

(No prerequisite)

This is a one semester sociological survey of major racial/ethnic groups in American society. This course will focus on historical experiences and their relationship to contemporary social realities faced by these racial/ethnic groups in American society. It will also investigate their contributions and special experiences as minorities.

SOC 128 SPECIAL TOPICS

See Special Topics listing (Variable units) [CSU](#)

SOC 129 INDEPENDENT STUDY

See Independent Study listing (1-3 units) [CSU](#)

SOC 138 COOPERATIVE EDUCATION

See Cooperative Education listing (1-8 units) [CSU](#)

The study of Spanish has as its goals to explain, evaluate and communicate ideas and concepts by means of reading, writing and verbal processes through creative use of words (literature) and culture (civilization). This study affords insight into foreign attitudes and methods and encourages free communication, written and oral, among people.

Career Opportunities

Advertising, Business, Education, Government, Health Service, International Business, Journalism, Law Enforcement, Publishing, Social Work, Translating, Writing and Mass Media

Faculty

Cuahtemoc Franco | Martha Vila

Degrees and Certificates Awarded

Associate in Arts, Liberal Arts

Associate Degree

No associate degree offered with a major in Spanish. Spanish courses may be used to fulfill requirements for an Associate in Arts degree with a major in Liberal Arts. See Liberal Arts for degree requirements for this major.

Transfer

For the most up-to-date information on these programs and others, visit www.assist.org. Please stop by the Transfer Center in Building 55 or make an appointment with a counselor if you have questions.

- *California State University, San Bernardino: Spanish major*
- *University of California, Riverside: Spanish major*

Spanish Courses

Spanish 101 through 104 include both classroom sessions and Internet activities.

Students may enroll in Spanish 102 if they have completed three or more years of high school Spanish, or if they are native Spanish speakers who have taken two or more years of high school Spanish.

Students may enroll in Spanish 103 if they have completed the AP exam with a score of 4 or 5, or are native Spanish speakers and have taken at least three years of high school Spanish.

SPAN 101 ELEMENTARY SPANISH

Units: 5.0 *CSU, UC* | 80-90 hours lecture

(No prerequisite)

This course provides an introduction to the Spanish language and the culture of its speakers. Fundamentals of pronunciation, structure and Hispanic culture are studied to develop the ability to use and understand basic spoken and written Spanish. Special emphasis is given to development of oral and aural skills by in classroom exercises and assignment of activities to reinforce course content on the Internet.

SPAN 101A FUNDAMENTALS OF SPANISH 101A

Units: 3.0 *CSU, UC* | 48-54 hours lecture

(No prerequisite)

This course provides an introduction to the Spanish language and culture. Fundamentals of pronunciation, structure and Hispanic culture are studied. Special emphasis is given to development of oral and aural skills. SPAN 101A and SPAN 101B are equivalent to SPAN 101. Upon completion of SPAN 101A and SPAN 101B, CSU will only accept five units for transfer.

Spanish Courses

SPAN 101B FUNDAMENTALS OF SPANISH 101B

Units: 3.0 [CSU, UC](#) | 48-54 hours lecture

(Prerequisite: SPAN 101A minimum grade C.)

This course is a continuation of SPAN 101A. It provides an introduction to Spanish language and culture. Fundamentals of pronunciation, structure and Hispanic culture are studied. Special emphasis is given to development of oral and aural skills. SPAN 101A and SPAN 101B are equivalent to SPAN 101. Upon completion of SPAN 101A and SPAN 101B, CSU will only accept five units for transfer.

SPAN 102 ELEMENTARY SPANISH

Units: 5.0 [CSU, UC](#) | 80-90 hours lecture

(Prerequisite: Completion of SPAN 101 minimum grade C or SPAN 101A and SPAN 101B.)

This course is a continuation of SPAN 101. Further study of pronunciation, structure and Hispanic culture are studied to develop the ability to use and understand basic spoken and written Spanish. Students continue the development of oral and aural skills by in classroom exercises and assignment of activities to reinforce course content on the Internet.

SPAN 103 INTERMEDIATE SPANISH

Units: 3.0 [CSU, UC](#) | 48-54 hours lecture

(Prerequisite: SPAN 102 or AP high school Spanish exam with a score of 4 or 5, or SPAN 102A and SPAN 102B.)

Provides an expanded review of key grammatical concepts and develops vocabulary with emphasis on composition, reading and discussions in Spanish. Students study Hispanic cultures based on cultural and literary materials.

SPAN 104 INTERMEDIATE SPANISH

Units: 3.0 [CSU, UC](#) | 48-54 hours lecture

(Prerequisite: Completion of SPAN 103 minimum grade C.)

A continuation of an expanded review of key grammatical concepts and develops vocabulary with emphasis on composition, reading and discussions in Spanish. Students study Hispanic cultures based on cultural and literary materials.

SPAN 125 CONVERSATIONAL SPANISH I

Units: 3.0 [CSU](#) | 48-54 hours lecture

(No prerequisite. Grade Option)

This is the first of two courses covering the essentials of Spanish conversation. It is a basic introductory course which emphasizes oral practice, pronunciation and vocabulary development. It is designed to develop a speaking and understanding knowledge of Spanish for use in everyday conversational situations. This course is designed for non-native speakers of the language.

SPAN 128 SPECIAL TOPICS

See Special Topics listing (Variable units). [CSU](#)

SPAN 129 INDEPENDENT STUDY

See Independent Study listing (1-3 units). [CSU](#)

Special Topics Courses

SPECIAL TOPICS 98-128-148

Units: 0.5-9.0

48-54 hours lecture

(Prerequisites for Special Topics courses will be in keeping with the California Administrative Code, Title V regulations on open classes, and any prerequisites will be based on terms of performance or specific knowledge necessary to successful performance in the class).

These courses are designed to permit investigation in depth of topics not covered by regular catalog offerings. Course content, hours, and unit credit to be determined by the instructor in relation to community/student interest and/or available staff. May be offered as a seminar, lecture, or laboratory class. Individual course descriptions approved by the Curriculum Committee are on file in Office of Instruction. Special Topics 128 and 148 transfer to CSU, UC. (UC maximum credit allowed: 3.3 semester units per term, 6 units total, in any or all appropriate subject areas combined. Granting of credit by a UC campus contingent on evaluation of course outline.)

Note: UC credit for special topics courses is given only after a review of the scope and content of the course by the enrolling UC campus. This usually occurs after transfer and may require recommendations from faculty. UC does not grant credit for special topics courses in Journalism, Photography, Health, Business Administration, Architecture, Administration of Justice (Criminology) or Library Departments because of credit restrictions in these areas.

Theater Arts

Theatre Arts is the essence of the humanities in that it is the only art form that incorporates all the other fine arts into its final product. Our primary goal is to educate the whole person, to emphasize comprehensive education. Everyone should experience the dynamics of theatre, and our ensemble technique teaches cooperation, teamwork, and communication. The skills learned in producing theatre are necessary in every occupational arena.

Career Opportunities

Actor/Actress, Choreographer, Costumer, Makeup Artist, Publicist, Scene Designer, Screenwriter, Sound Technician, Stage Director, Teacher, Lighting Designer, Properties, Lighting Technician, Stage Manager, Assistant State Director, Scenic Artist, Costumer Designer, Set Dresser, Assistant Stage Manager, Writer, Musicians, Singers, Entertainers, Performers, Set Designers, Agents, Business Mangers of Artists and Performers, Dancers

Faculty

Ed Heaberlin | Dr. John Rude - Emeritus
Theresa Mirci-Smith - Emeritus

Degrees and Certificates Awarded

Associate in Arts, Fine Arts
Associate in Arts, Liberal Arts

Associate Degree

No associate degree offered with a major in Theatre Arts. Theatre Arts courses may be used to fulfill requirements for an Associate in Arts degree with a major in Fine Arts or Liberal Arts. See specific listings for requirements in these majors.. TA 138 (Cooperative Education) may be used as elective credits, but may not be used to fulfill major requirements.

Transfer

For the most up-to-date information on these programs and others, visit www.assist.org. Please stop by the Transfer Center in Building 55 or make an appointment with a counselor if you have questions.

- **California State University, San Bernardino:** Theatre Arts major
- **University of California, Riverside:** Theatre Arts major

Theater Arts Courses

TA 101 INTRODUCTION TO THEATRE

Units: 3.0 CSU, UC 48-54 hours lecture

(No prerequisite)

An introductory course of the history, the performers, the purpose, and the perspective of theatre. Students will be introduced to the basic forms of theatre and disciplines involved in producing a play. Emphasis is on defining and experiencing the role of theatre in society.

TA 102 HISTORY OF THEATRE

Units: 3.0 CSU, UC 48-54 hours lecture

(No prerequisite)

A survey course designed to introduce the student to a history of the world's theatrical experiences from primitive times to the present. An examination of the physical theatre and methods of staging drama from the days of the caveman to theatre of the avant-garde.

TA 104 ORAL INTERPRETATION OF LITERATURE

Units: 3.0 CSU, UC 48-54 hours lecture

(No prerequisite)

A course designed for the student to learn to interpret literature for an audience. Students will learn and be evaluated on: doing performance analyses, developing relevant introductions, communicating a relevant theme, executing proper character placement and focus, using effective vocal skills, using effective physical involvement. Students will demonstrate proficiency in the above through solo and ensemble class presentations.

Theater Arts Courses

TA 106 BEGINNING ACTING

Units: 3.0 **CSU, UC** | **48-54 hours lecture**

(No prerequisite)

This course is designed to exercise the separate parts of the composite art of acting which include thought, emotion, and specific movement and vocal techniques. Emphasis is placed on pantomime and exercises culminating in scene work. The ultimate goal is to develop a firm foundation in basic acting techniques.

TA 107 INTERMEDIATE ACTING

Units: 3.0 **CSU, UC** | **48-54 hours lecture**

(No prerequisite. Recommended preparation: TA 106.)

This course provides the student an opportunity to enhance acting skills, and to develop and intensify dramatic ability by advancing the understanding of skills presented in Beginning Acting. The student will be introduced to the process of analyzing character through lecture, demonstration, exercises, and the rehearsal and presentation of scenes from published texts.

TA 109 REHEARSAL & PERFORMANCE STUDIO

Units: 3.0 **CSU, UC** | **16-18 hours lecture and 96-108 hours laboratory**

(Prerequisite: Qualify for cast at open auditions. TA 106 recommended)

This course will provide study and laboratory exploration in all aspects of play production involving the actor in order to develop his/her acting capabilities, skills, and discipline. The audition, preparation, and presentational phases of the acting process will be explored under the supervision and guidance of a faculty director. Productions will be presented for public performance. Enrollment is for the duration of the preparation and presentation phases of production.

TA 110 PRINCIPLES OF DESIGN FOR THEATRE

Units: 3.0 **CSU, UC** | **32-36 hours lecture and 48-54 hours laboratory**

(No prerequisite.)

An introductory course in design principles as applied to the theatre in the areas of lighting, costuming, makeup, and set design. Students will apply concepts of texture, line, space, color and perspective to the various design aspects in theatre through specific 2-D and 3-D exercises.

TA 111 TECHNICAL STAGE PRODUCTION

Units: 3.0 **CSU, UC** | **16-18 hours lecture and 96-108 hours laboratory**

(No prerequisite.)

This course is an introduction to the tasks, responsibilities, and skills of stage technicians. Stage managing, construction techniques, stage equipment use, and function of technical stage personnel are introduced to develop the student's design capabilities, skills, and discipline in stage production. Students will serve as technical stage crew members in Theatre Arts Department productions.

TA 113 STAGE MAKE-UP

Units: 3.0 **CSU** | **16-18 hours lecture and 96-108 hours laboratory**

(No prerequisite. Grade Option)

A course designed to introduce the student to the basic techniques and materials of stage make-up. The student will demonstrate understanding through actual make-up, wig, and facial hair applications in the classroom.

TA 114 PLAY WRITING

Units: 3.0 **CSU** | **48-54 hours lecture**

(No prerequisite)

This is a practical writing, analysis and critique course designed to introduce students to the fundamentals of play writing while teaching them to constructively critique their own writing. Lecture topics include dramatic structure, dramatic action, the relationship between dialogue and action, characterization, setting, time & locale, theme, and point of view.

Theater Arts Courses

TA 115 STAGECRAFT

Units: 2.0-4.0 **CSU, UC** | **16-18 hours lecture and 48-54 hours laboratory per unit per term**

(No prerequisite)

An introductory course on the materials, tools, and procedures of all technical phases of scene production including construction, painting, rigging, placement and manipulation of stage scenery, the organization and management of stage activity, and stagecraft terminology. Students are introduced to the fundamentals of set design, construction, painting, and finishing. Course is designed for the beginner and may be repeated four times for a maximum of 16 units.

TA 115.1 STAGECRAFT

Units: 1.0 **CSU, UC** | **48-54 hours laboratory**

(No prerequisite)

An introductory course on the materials, tools and procedures of theatre set production including construction, painting, rigging, placement and manipulation of stage scenery, the organization and management of set pieces, and stagecraft terminology. Students are introduced to the fundamentals of set design, construction, painting and finishing.

TA 115.2 STAGECRAFT

Units: 2.0 **CSU, UC** | **96-108 hours laboratory**

(No prerequisite)

An introductory course on the materials, tools and procedures of theatre set production including construction, painting, rigging, placement and manipulation of stage scenery, the organization and management of set pieces, and stagecraft terminology. Students are introduced to the fundamentals of set design, construction, painting and finishing.

TA 115.3 STAGECRAFT

Units: 3.0 **CSU, UC** | **144-162 hours laboratory**

(No prerequisite)

An introductory course on the materials, tools and procedures of theatre set production including construction, painting, rigging, placement and manipulation of stage scenery, the organization and management of set pieces, and stagecraft terminology. Students are introduced to the fundamentals of set design, construction, painting and finishing.

TA 115.4 STAGECRAFT

Units: 4.0 **CSU, UC** | **192 - 216 hours laboratory**

(No prerequisite)

An introductory course on the materials, tools and procedures of theatre set production including construction, painting, rigging, placement and manipulation of stage scenery, the organization and management of set pieces, and stagecraft terminology. Students are introduced to the fundamentals of set design, construction, painting and finishing.

TA 116 AUTHORS OF THE THEATRE

Units: 3.0 **CSU, UC** | **48-54 hours lecture**

(No prerequisite)

A survey of playwrights from the Greeks to the present. The selected plays are read, discussed, and analyzed. It is both AA and BA applicable. See cross listing for ENGL 116.

TA 117 TECHNICAL THEATRE: LIGHTING AND SOUND

Units: 3.0 **CSU, UC** | **32-36 hours lecture and 48-54 hours laboratory**

(No prerequisite)

This course will provide the student with a theoretical and practical introduction to theatre technology. This course will cover the theatre plant, rigging, theatre personnel, electrical theory, stage lighting and design, and audio signal flow, operation and design. Emphasis is on hands-on applications.

TA 120 COSTUMING FOR THE THEATRE

Units: 3.0 **CSU** | **16-18 hours lecture and 96-108 hours laboratory**

(No prerequisite)

A basic course in the skills of costuming for the stage and the art of costume design. Course will introduce creation of specialty items, stylistic interpretations, crew management and organization responsibilities.

TA 128 SPECIAL TOPICS

See Special Topics listing (Variable units). [CSU](#)

TA 129 INDEPENDENT STUDY

See Independent Study listing (1-3 units) [CSU](#).

TA 138 COOPERATIVE EDUCATION

See Cooperative Education listing (1-8 units) [CSU](#)

TA 160A TAP DANCE IA (Formerly TA 160)

Units: 1.0 [CSU, UC](#) | 48-54 hours laboratory

(No prerequisite. Grade Option)

Students who would like to explore tap dancing for the first time will experience basic tap dancing techniques with the foundational sense of musicality. During this course, many essential elements will be stressed: style, proper counting techniques, rhythm, interpretation of music and basic choreographic elements. See cross listing for KIND 160A.

TA 160B TAP DANCE 1B

Units: 1.0 [CSU, UC](#) | 48-54 hours laboratory

(No prerequisite. Grade Option)

Students who would like to further explore tap dancing after having some tap experience will expand on their basic tap dance techniques with the foundational sense of musicality. During this course, many essential elements will be stressed: style, proper counting techniques, rhythm, interpretation of music and basic choreographic elements. Emphasis will be placed on enhancing musical and rhythmic phrasing and performance clarity in movement combinations. See cross listing for KIND 160B.

TA 160C TAP DANCE 1C

Units: 1.0 [CSU, UC](#) | 48-54 hours laboratory

(No prerequisite. Grade Option)

Students who would like to further explore tap dancing after having some tap experience and preparing for Tap IIA will expand on their tap dance techniques with the foundational sense of musicality. During this course, many essential elements will be stressed: style, proper counting techniques, rhythm, interpretation of music and basic choreographic elements. Emphasis will be placed on enhancing musical and rhythmic phrasing and performance clarity in complex movement combinations , and the refinement of performance style. See cross listing for KIND 160C.

TA 161A TAP DANCE IIA

Units: 1.0 [CSU](#) | 48-54 hours laboratory

(No prerequisite. Grade Option)

Students who would like to explore tap dancing at an intermediate level for the first time after having had some tap dance will experience intermediate tap dancing techniques with the foundational sense of musicality. During this course, many essential elements will be stressed: style, proper counting techniques, rhythm, interpretation of music and basic choreographic elements. See cross listing for KIND161A.

TA 161B TAP DANCE IIB

Units: 1.0 [CSU, UC](#) | 48-54 hours laboratory

(No prerequisite. Grade Option)

Students who would like to further explore tap dance at an intermediate level after having had some tap dance will experience intermediate tap dance techniques with a fundamental sense of musicality. During this intermediate course a number of elements will be stressed: style, proper counting techniques, rhythm, interpretation of music and basic choreographic elements. Emphasis will be placed on enhancing musical and rhythmic phrasing, efficient alignment, and performance clarity in movement combinations. See cross listing for KIND161B.

Theater Arts Courses

TA 161C TAP DANCE IIC

Units: 1.0 CSU, UC | 48-54 hours laboratory

(No prerequisite. Grade Option)

Students who would like to further explore tap dance at an intermediate level, working towards Tap III, after having some tap dance will experience intermediate tap dance techniques with a fundamental sense of musicality. During this course a number of elements will be stressed: style, proper counting techniques, rhythm, interpretation of music and basic choreographic elements. Emphasis is placed on enhancing musical and rhythmic phrasing, efficient alignment, performance clarity in complex movement combinations, and the refinement of performance style. See cross listing for KIND 161C.

TA 166A INTRODUCTION TO BALLET DANCE IA

Units: 1.0 CSU, UC | 48-54 hours laboratory

(No prerequisite. Grade Option)

Student with no previous training or experience in ballet will explore introductory level ballet technique, style, and movement characteristics through dancing. See cross listing for KIND 166A.

TA 166B BUILDING BALLET BASICS 1B

Units: 1.0 CSU, UC | 48-54 hours laboratory

(No prerequisite. Grade Option)

Students with introductory level ballet training will build and expand basic ballet technique, style, and movement characteristics. See cross listing for KIND 166B.

TA 166C BALLET FUNDAMENTALS 1C

Units: 1.0 CSU, UC | 48-54 hours laboratory

(No prerequisite. Grade Option)

Students who have previous training in introductory Ballet IA and Building Ballet Basics IB will further explore and perfect their training in ballet fundamentals. See cross listing for KIND 166C.

TA 167A INTRODUCTION TO INTERMEDIATE BALLET IIA

Units: 1.0 CSU, UC | 48-54 hours laboratory

(No prerequisite. Grade Option)

An introduction to the technique and style of beginning intermediate level Ballet IIA dance. This course is for the student who has taken Ballet I level courses. Emphasis on exploring the movement characteristics of beginning intermediate level Ballet IIA dance through dancing. See cross listing for KIND 167A.

TA 167B INTERMEDIATE BALLET DANCE IIB

Units: 1.0 CSU, UC | 48-54 hours laboratory

(No prerequisite. Grade Option)

Students who have been introduced to intermediate Ballet IIA will build and explore intermediate ballet IIB skills and concepts. See cross listing for KIND 167B.

TA 167C INTERMEDIATE BALLET IIC

Units: 1.0 CSU, UC | 48-54 hours laboratory

(No prerequisite. Grade Option)

Students who have training in Intermediate Ballet IIA and Intermediate Ballet IIB will explore and build advanced intermediate ballet skills. See cross listing for KIND 167C.

TA 170A JAZZ DANCE 1A

Units: 1.0 CSU, UC | 48-54 hours laboratory

(No prerequisite. Grade Option)

Students who would like to explore jazz dance for the first time will experience basic jazz dance techniques with a fundamental sense of musicality. During this beginning course a number of elements will be stressed: style, proper counting techniques, rhythm, interpretation of music and basic choreographic elements. See cross listing for KIND170A.

Theater Arts Courses

TA 170B JAZZ DANCE 1B

Units: 1.0 CSU, UC 48-54 hours laboratory

(No prerequisite. Grade Option)

Students who would like to further explore jazz dance after having some jazz dance experience will expand on their basic jazz dance techniques and fundamental sense of musicality. During this course a number of elements will be stressed: style, proper counting techniques, rhythm, interpretation of music and basic choreographic elements. Emphasis will be placed on enhancing musical and rhythmic phrasing, efficient alignment, and performance clarity in movement combinations. Other styles such as theater jazz may be incorporated. See cross listing for KIND 170B.

TA 170C JAZZ DANCE 1C

Units: 1.0 CSU, UC 48-54 hours laboratory

(No prerequisite. Grade Option)

Students who would like to further explore jazz dance after having some jazz dance experience, will expand on their jazz dance techniques and fundamental sense of musicality. During this course a number of elements will be stressed: style, proper counting techniques, rhythm, interpretation of music and basic choreographic elements. Emphasis is placed on enhancing musical and rhythmic phrasing, efficient alignment, performance clarity in complex movement combinations, and the refinement of performance style. See cross listing for KIND 170C.

TA 171A JAZZ DANCE IIA

Units: 1.0 CSU, UC 48-54 hours laboratory

(No prerequisite. Grade Option)

Students who would like to explore jazz dance at an intermediate level for the first time after having had some jazz dance will experience intermediate jazz dance techniques with a fundamental sense of musicality. During this intermediate course a number of elements will be stressed: style, proper counting techniques, rhythm, interpretation of music and basic choreographic elements. See cross listing for KIND 171A.

TA 171B JAZZ DANCE IIB

Units: 1.0 CSU, UC 48-54 hours laboratory

(No prerequisite. Grade Option)

Students who would like to further explore jazz dance at an intermediate level after having had some jazz dance will experience intermediate jazz dance techniques with a fundamental sense of musicality. During this intermediate course a number of elements will be stressed: style, proper counting techniques, rhythm, interpretation of music and basic choreographic elements. Emphasis will be placed on enhancing musical and rhythmic phrasing, efficient alignment, and performance clarity in movement combinations. See cross listing for KIND 171B.

TA 171C JAZZ DANCE IIC

Units: 1.0 CSU, UC 48-54 hours laboratory

(No prerequisite. Grade Option)

Students who would like to further explore jazz dance at an intermediate level, working towards Jazz III, after having some jazz dance will experience intermediate jazz dance techniques with a fundamental sense of musicality. During this course a number of elements will be stressed: style, proper counting techniques, rhythm, interpretation of music and basic choreographic elements. Emphasis is placed on enhancing musical and rhythmic phrasing, efficient alignment, performance clarity in complex movement combinations, and the refinement of performance style. See cross listing for KIND 171C.

TA 174A INTRODUCTION TO MODERN DANCE I

Units: 1.0 CSU 48-54 hours laboratory

(No prerequisite. Grade Option)

Introduction to technique and stylization of modern dance. For the student who has never had modern dance or who is new to the beginning level of modern dance. Emphasis on exploring the movement characteristics of introductory level modern dance through dancing. See cross listing for KIND 174A.

Theater Arts Courses

TA 174B BASIC MODERN DANCE I

Units: 1.0 CSU | 48-54 hours laboratory

(No prerequisite. Grade Option)

Basic technique and stylization of modern dance. For the student who has never had modern dance or who is new to the beginning level of modern dance. Emphasis on exploring the movement characteristics of introductory level modern dance through dancing. See cross listing for KIND 174B.

TA 175A INTRODUCTION TO MODERN DANCE II

Units: 1.0 CSU, UC | 48-54 hours laboratory

(No prerequisite. Grade Option)

Technique and stylization of introductory level modern dance II. This course is for the student who has taken Modern Dance I level classes. Emphasis on exploring the movement characteristics of introductory level modern dance II through dancing. See cross listing for KIND175A.

TA 180 INTRODUCTION TO CLASSICAL MUSICAL THEATRE DANCE

Units: 1.0 CSU, UC | 48-54 hours laboratory

(No prerequisite. Grade Option)

This course is an in-depth performance experience focusing on styles of body movement indicative of Classical Musical Theatre stage productions (1943 – 1965). The fundamentals of Classical musical theatre dance will be introduced, including Classical Broadway jazz and tap style genres. Concepts of the history of dance in Classical musical theatre will also be introduced. See cross listing for KIND 180.

TA 181 INTRODUCTION TO CONTEMPORARY MUSICAL THEATRE DANCE

Units: 1.0 CSU, UC | 48-54 hours laboratory

(No prerequisite. Grade Option)

This course is an in-depth performance experience focusing on styles of body movement indicative of Contemporary Musical Theatre stage productions (1966 – Present). The fundamentals of Contemporary musical theatre dance will be introduced, including Contemporary Broadway jazz and tap style genres. Concepts of the history of dance in Contemporary musical theatre dance will also be introduced. See cross listing for KIND 181.

TA 182 BEGINNING CLASSICAL MUSICAL THEATRE DANCE

Units: 1.0 CSU, UC | 48-54 hours laboratory

(No prerequisite. Grade Option)

Technique and style of beginning Classical theatre dance (1943 - 1965) will be explored. This course is an in-depth performance experience focusing on styles of body movement for Classical Musical Theatre stage productions. The fundamentals of Broadway style dance will be reviewed, including basic Classical jazz and tap. Classical Musical theatre dance genres will be introduced by category, including more sophisticated character stylization of Classical musical staging. Concepts of the history of classical musical theatre dance will be further explored. See cross listing for KIND 182.

TA 183 BEGINNING CONTEMPORARY MUSICAL THEATRE DANCE

Units: 1.0 CSU, UC | 48-54 hours laboratory

(No prerequisite. Grade Option)

Technique and style of beginning Contemporary theatre dance (1966 - Present) will be explored. This course is an in-depth performance experience focusing on styles of body movement for Contemporary Musical Theatre stage productions. The fundamentals of Contemporary Broadway style dance will be reviewed, including basic Contemporary jazz and tap. Contemporary Musical theatre dance genres will be introduced by category, including more sophisticated character stylizations of Contemporary musical staging. Concepts of the history of Contemporary musical theatre dance will be further explored.

TA 203 SCRIPT ANALYSIS

Units: 3.0 CSU 48-54 hours lecture

(No prerequisite.)

A script for a play contains the words of a playwright which serve as a blueprint from which directors, designers, and actors create the world of the play for an audience. Thorough analysis of the play is critical for the writer's world to be fully realized on the stage. Students will learn to closely examine the play script using various methods of analysis in order to make informed choices about performance, directing, technical elements and design elements.

TA 271 JAZZ DANCE IV

Units: 1.0 CSU 48-54 hours laboratory

(No prerequisite. Grade Option)

Technique and style of level IV jazz dance. Emphasis on exploring the movement characteristics of advanced level IV jazz through dancing.

TA 274 MODERN DANCE III

Units: 1.0 CSU 48-54 hours laboratory

(No prerequisite. Grade Option)

Technique and style of intermediate level III modern dance. Emphasis on exploring the movement characteristics of intermediate level III modern dance through dancing.

Welding

This program prepares students to enter welding-related occupations, offers retraining for those seeking a new career, and provides an opportunity for those employed in welding occupations to learn new skills and upgrade themselves in their positions.

The department is a member of the American Welding Society's Educational Institution Program for entry level welders and is entitled to all the privileges. This entry level welder program is part of the National Skills Standards Program, which is being enacted across a wide range of industries in the United States.

The program prepares students to pass the written test and welding performance test necessary to acquire a welding license from the Los Angeles Department of Building and Safety. The program offers a certificate of achievement in welding, and an associate degree may be obtained upon completion of 20 units of welding course work in addition to general education.



Educational Institution Member



**Fabricators & Manufacturers
Association, International®
MEMBER**

Career Opportunities

Boilermakers, Iron Workers, Maintenance Worker, Millwrights, Sheet Metal Workers, Welder, Welder-Fitter, Welding Estimator, Welding Inspector, Welding Instructor, Welding Operator, Welding Sales Representative, Welding Service Representative, Welding Supervisor, Welding Technician

Degrees and Certificates Awarded

Associate in Science, Welding

Welding Certificate

Program Learning Outcomes

A student receiving a degree or certificate in this field will be able to:

- Demonstrate acceptable safety practices daily in order to prevent injuries of any type.
- Practice and perform welder qualification testing at the appropriate level for the course.
- Interpret drawings and welding symbols in order to weld the correct weld type and size per the detailed joint design.
- Practice and demonstrate welding and cutting job practices in multiple processes appropriate for being a combination welder.

Associate Degree

To earn an Associate in Science degree with a major in Welding (04947), complete 20 units from Welding courses and meet all Victor Valley College graduation requirements. WELD 138 (Cooperative Education) may be used as elective credit, but may not be used to fulfill major requirements.

Transfer

Not a transfer major.

WELDING CERTIFICATE OF ACHIEVEMENT (20542)

The Welding Technology courses included in the certificate program will give the students the skills necessary to become an entry-level combination welder.

Units Required: 20.0

All of the following must be completed:

WELD 51	Oxyacetylene Welding, Cutting, and Brazing	3.5
WELD 52	Shielded Metal Arc Welding-Basic	3.5
WELD 53	Shielded Metal Arc Welding-Advanced	4.0
WELD 57A	Gas Tungsten Arc Welding-Basic	2.0
WELD 57B	Gas Tungsten Arc Welding-Advanced	2.0
WELD 58A	Gas Metal Arc Welding-Basic	2.0
WELD 58B	Gas Metal Arc Welding-Advanced	2.0
WELD 59	Welding Symbols and Blueprint Reading	1.0

Welding Courses

WELD 50 INTRODUCTION TO WELDING

Units: 2.0 | 16-18 hours lecture and 48-54 hours laboratory

(No prerequisite)

Survey course in arc and oxyacetylene welding which covers safety practices, use of equipment, and oxyacetylene cutting and braze welding.

WELD 51 OXYACETYLENE WELDING, CUTTING AND BRAZING

Units: 3.5 | 32-36 hours lecture and 72-81 hours laboratory

(No prerequisite)

Develops entry-level skills for the welder in gas welding, braze welding, and cutting.

WELD 52 SHIELDED METAL ARC WELDING - BASIC

Units: 3.5 | 32-36 hours lecture and 72-81 hours laboratory

(No prerequisite.)

Develops entry-level shielded metal arc welding (SMAW) skills for the welder.

WELD 53 SHIELDED METAL ARC WELDING - ADVANCED

Units: 4.0 | 32-36 hours lecture and 96-108 hours laboratory

(No prerequisite)

Develops skills to produce high quality multi-pass all position groove welds with and without backing.

WELD 54 PREPARATION FOR WELDER CERTIFICATION

Units: 1.0 | 16-18 hours lecture

(No prerequisite)

This course prepares the welder to take the Los Angeles Department of Building and Safety written examination required for the L.A. City welding license.

WELD 57A GAS TUNGSTEN ARC WELDING - BASIC

Units: 2.0 | 16-18 hours lecture and 48-54 hours laboratory

(No prerequisite)

Develops entry-level gas tungsten arc welding skills; setting up and adjusting equipment, and in-position welding on mild steel, stainless steel, and aluminum.

Welding Courses

WELD 57B GAS TUNGSTEN ARC WELDING - ADVANCED

Units: 2.0 | 16-18 hours lecture and 48-54 hours laboratory

(No prerequisite)

Develops advanced gas tungsten arc welding skills in out-of-position welding on mild steel, stainless steel, and aluminum.

WELD 58A GAS METAL ARC WELDING - BASIC

Units: 2.0 | 16-18 hours lecture and 48-54 hours laboratory

(No prerequisite)

Develops entry-level skills in gas metal arc welding. Specifically develops skills on all position groove and fillet welds, set-up, adjustment and equipment maintenance.

WELD 58B GAS METAL ARC WELDING - ADVANCED

Units: 2.0 | 16-18 hours lecture and 48-54 hours laboratory

(No prerequisite)

Develops advanced skills in gas metal arc welding. Specifically develops skills on single-vee groove butt joints in all positions and welder qualification practice.

WELD 59 WELDING SYMBOLS AND BLUEPRINT READING

Units: 1.0 | 16-18 hours lecture

(No prerequisite)

Develops a technical understanding of engineering drawings and use of information to communicate instructions from the design to the welder and fitter to achieve design objectives.

WELD 60A WELDING LABORATORY SHIELD METAL ARC WELDING

Units: 1.0-2.0 | 48-54 hours of laboratory for one unit of credit

(No prerequisite)

A laboratory class to develop skills in arc welding and welder qualification preparation. Offered Fall/Winter/Spring/Summer sessions

WELD 60B WELDING LABORATORY GAS TUNGSTEN ARC WELDING

Units: 1.0-2.0 | 48-54 hours of laboratory for one unit of credit

(No prerequisite)

A laboratory class to develop skills in gas tungsten arc welding and welder performance qualification. Offered Fall/Winter/Spring/Summer sessions

WELD 60C WELDING LABORATORY GAS METAL ARC WELDING

Units: 1.0-2.0 | 48-54 hours of laboratory for one unit of credit

(No prerequisite)

A laboratory class to develop skills in gas metal arc welding and welder performance qualification. Offered Fall/Winter/Spring/Summer sessions

WELD 60D WELDING LABORATORY FCAW

Units: 1.0 | 48-54 hours of laboratory

(No prerequisite)

A laboratory class to develop skills in flux cored arc welding or welder performance qualification. Offered Fall/Winter/Spring/Summer sessions.

WELD 60D WELDING LABORATORY FCAW

Units: 4.0 | 32-36 hours lecture and 96-108 hours of laboratory

(No prerequisite)

Develops skills to produce high quality multi-pass all position groove welds with backing on varying thicknesses of base material utilizing Gas-Shielded and Self-Shielded Flux Core Wires.

Welding Courses

WELD 98 SPECIAL TOPICS

See Special Topics listing (Variable units).

WELD 99 INDEPENDENT STUDY

See Independent Study listing (1-3 units).

WELD 138 COOPERATIVE EDUCATION

See Cooperative Education listing (1-8 units). [CSU](#)

Non-Credit Courses

Adult Physical Fitness (ADPE) Courses

ADPE 41A ADVANCED PHYSICAL FITNESS

Units: 0.0

(No prerequisite)

Advanced techniques of exercise through use of a variety of controlled exercises. This class is open to both men and women.

ADPE 80 ADULT TENNIS

Units: 0.0

(No prerequisite)

Tennis for adults is fun, offers excellent exercise, and a way to make friends while enjoying tennis. Enhance your tennis skills and quality of life.

ADPE 90 HAWAIIAN DANCE FOR OLDER ADULTS

Units: 0.0

(No prerequisite)

Instruction of basic steps of Hawaiian dance, arm movements, terminology, the usage of Hawaiian implements for routines to Hawaiian music. Dance for the older adult offers excellent exercise and a way to make friends while enjoying the class. Enhances mental and physical skills and quality of life.

Basic Skills/Educational Upgrade Courses

ACOM 12 ADULT LITERACY

Units: 0.0

(No prerequisite)

An open entry/open exit class designed for persons unable to read beyond the 4th grade level. Students will receive individualized instruction.

ACOM 30 CITIZENSHIP PREPARATION

Units: 0.0

(No prerequisite)

This course is designed for immigrants eligible for the naturalization process. Topics include U.S. History and civic education. This class will focus on practicing listening and responding to the N-400 application questions, reading and responding to the 100 questions, and writing simple sentences to help pass the naturalization interview.

ACOM 35K MATHEMATICS TUTORING

Units: 0.0

(Corequisite: Enrollment in a Credit Math Course)

This course is for students wishing to receive tutoring in the Math Success Center at VVC. Students will be allowed to receive up to 96 hours of tutoring over a two semester period of time. Tutoring topics will be based on math skills covered in the co-requisite math course.

ACOM 35G SUPERVISED TUTORING

Units: 0.0

(No prerequisite)

Open entry/open exit classes designed for students who need individualized instruction.

BSKL 8A CAHSEE PREPARATION - ENGLISH

Units: 0.0

32-36 hours lecture and 24-27 hours laboratory

(No prerequisite)

The course prepares students to take the CAHSEE in English. Students review skills in both reading comprehension and writing skills.

BSKL 8B CAHSEE PREPARATION MATH

Units: 0.0

32-36 hours lecture and 24-27 hours laboratory

(No prerequisite)

The course provides supplemental instruction in math in preparation for California High School Exit Exam (CAHSEE).

Non-Credit Courses

English As A Second Language Non-Credit (AENG) Courses

AENG 1 CITIZENSHIP PREPARATION LEVEL 1

Units: 0.0

(No prerequisite)

This course is for very limited English speakers wishing to prepare for the Naturalization interview. The course focuses on improving spoken English language skills required to pass the Naturalization test.

AENG 2 CITIZENSHIP PREPARATION LEVEL 2

Units: 0.0

(No prerequisite)

This course is designed for immigrants eligible for the naturalization process. The class will focus on practicing language skills needed to pass the written and oral naturalization interview. Students will practice responding to questions from the interview and the 100 questions as well as reading and writing basic sentences of everyday life, civics and U.S. History.

AENG 10.1 LOW BEGINNING LISTENING AND SPEAKING REVIEW

Units: 0.0

(No prerequisite)

Designed for non-native speakers with no or very limited English. It is intended to develop a basic understanding of English. Students will begin to respond to direct questions, statements, high-frequency commands and courtesies; begin to participate in conversations with peers on familiar topics with supported context.

AENG 10.1C LOW BEGINNING ESL COMPUTER SKILLS

Units: 0.0

(No prerequisite)

This class is for ESL students with very little English skills who would like to learn the basics of computers. The class will reinforce English skills using the computer as a tool to learn English. Students will learn basic computer literacy, keyboarding and internet skills for success in school and personal use.

AENG 10.2 LOW BEGINNING READING AND WRITING

Units: 0.0

(No prerequisite)

This class is for people who do not read or write any English. It will focus on basic reading and writing skills. Students will learn to read and write basic sentences. Fill out simplified forms, such as basic job applications. They will learn basic vocabulary.

AENG 10.3 HIGH BEGINNING SPEAKING AND LISTENING

Units: 0.0

(No prerequisite)

This course continues to develop English skills of non-native speakers of English. Students will expand their listening and speaking skills with lab activities, role-playing, and teacher led activities. Students will practice responding to simple questions related to basic needs, make simple statements and learn everyday expressions related to immediate needs.

AENG 10.4 HIGH BEGINNING READING AND WRITING

Units: 0.0

(No prerequisite)

This class is designed for high beginning non-native English speakers who read and write at a very limited beginning level. The course will focus on basic reading and writing skills. Students will practice reading and filling out everyday forms. They will practice reading comprehension, vocabulary, rules of spelling, and basic grammar. Students will expand their knowledge of familiar words and phrases and use strategies to predict common words and phrases. Students will be introduced to simple narrative reading passages and identify patterns such as sequencing.

AENG 10.5 ESL LOW INTERMEDIATE SPEAKING AND LISTENING

Units: 0.0

(Recommended Preparation: AENG 10.3 or 10.4)

This course is for non-native English speakers wishing to continue to develop English skills. It is for people who already speak and understand English fairly well. In this course students will learn more grammar and vocabulary useful in a variety of everyday speaking and listening situations. Students will also be introduced to non-verbal communication, as well as certain idiomatic expressions. There will be a strong emphasis on simulation and role play.

AENG 10.6 ESL LOW INTERMEDIATE READING AND WRITING

Units: 0.0

(No prerequisite Recommended Preparation: AENG 10.4)

This class continues from AENG 10.4. It is for people who already speak and understand English fairly well. Students in this class will continue to develop reading and writing skills in English. They will continue learning grammar and spelling rules, and will write at the sentence level. They will learn to read and respond to simple stories and news articles, and other common forms of written material, such as instructions and simple warranties.

AENG 10.7 ESL LEVEL 4 HIGH INTERMEDIATE LISTENING AND SPEAKING

Units: 0.0

(Recommended Preparation: AENG 10.5 or AENG 10.6)

This class continues from AENG 10.5. It is for people who already speak and understand enough English to describe everyday situations, problems, and needs. In this class students will learn more advanced vocabulary, idiomatic expressions, sentence structure, and grammar needed in a variety of specific everyday speaking and listening situations. There will be continued emphasis on simulation and role play.

AENG 10.9 ESL LEVEL 5 BRIDGE FOR COLLEGE AND JOB SUCCESS

Units: 0.0

(Recommended Preparation: AENG 10.7 or qualifying placement scores)

This course is designed for non-native speakers of English who wish to improve English skills for career readiness, vocational training or for students interested in transitioning to college courses. Students will practice writing, grammar, listening, and speaking as it plays naturally in the workplace or in an academic setting. Students will be learning skills, such as interviewing skills, resume writing, and speaking confidently at work or in an academic setting.

Non-Credit Courses

Home Economics For The Homemaker (AHOM) Courses

AHOM 10 ADVANCED CLOTHING CONSTRUCTION

Units: 0.0

(No prerequisite)

Designed for those who understand the operation of a sewing machine, fabric selection and preparation, and fundamental sewing skills such as finishing seams, grading and understitching, etc. Emphasis on quality construction techniques with options for tailoring, fitting, specialty fabrics, etc.

AHOM 20 BEGINNING CLOTHING CONSTRUCTION

Units: 0.0

(No prerequisite)

Designed to teach basic sewing skills and equipment use. Emphasis on fundamentals, including use of equipment, knowledge of fabrics, and construction techniques.

AHOM 20.1 INTERMEDIATE CLOTHING CONSTRUCTION

Units: 0.0

(No prerequisite)

A structured class teaching advanced pattern techniques for those with basic sewing knowledge. Students should have beginning sewing skills or better.

AHOM 60 NEEDLECRAFT AND DESIGN

Units: 0.0

(No prerequisite)

This class specializes in basic to advanced stitches for knitting, crochet, needle point, cross stitch, lace making and pattern interpretation. This class is for beginners as well as intermediate and advanced students.

AHOM 70 HAND CRAFTED ITEMS

Units: 0.0

(No prerequisite)

Learn how to make small craft and quilting items for home and personal use.

AHOM 75 MACHINE QUILTING I

Units: 0.0

(No prerequisite)

A beginning class designed to teach strip sewing techniques for making quilts quickly and easily by machine.

AHOM 75.1 MACHINE QUILTING II

Units: 0.0

(No prerequisite)

A continuation of Machine Quilting I for those who desire more complicated patterns of quilts by machine.

AHOM 85 SERGER TECHNIQUES

Units: 0.0

(No prerequisite)

Designed to teach basic techniques including threading and tension adjustments. Learn both construction and decorative uses in project construction. Designed for both beginner and more advanced students.

Music (AMUS) Courses

AMUS 20 COMMUNITY CHORUS

Units: 0.0

(No prerequisite)

A large choral ensemble dedicated to the performance of major choral works from all musical periods, often with orchestra. Group may tour periodically in the United States and abroad. Membership open by solo audition to determine ability to match pitch, sing in tune, carry a harmony part, level of music reading. Prior choral experience in a high school, college/university, community or church choir desirable but not required.

AMUS 21 COMMUNITY BAND

Units: 0.0

(No prerequisite)

The study and performance of standard college large wind ensemble literature, stressing the proper playing and performance techniques. The development of warm up skills, scale studies, rhythmic refinement, and the full range of wind ensemble techniques will be emphasized. Public performance required. Prerequisite: Appropriate level of musical performance skill as demonstrated by audition.

AMUS 23 COMMUNITY ORCHESTRA

Units: 0.0

(No prerequisite)

A study and performance of standard orchestral literature. Public performances at college and community concerts and events. Open by audition.

AMUS 24 COMMUNITY JAZZ BAND

Units: 0.0

(No prerequisite)

Provides playing experience in the fields of dance, jazz, rock and popular music. Accurate execution and consistent style will be emphasized, along with improvisation, sight reading, ear training and performance practice skills. Public performances at college and community concerts. Open by audition.

AMUS 25 COMMUNITY SMALL ENSEMBLES

Units: 0.0

(Prerequisite: Audition to demonstrate performance at college level)

The class will explore small ensemble literature for various groupings of wind and brass instruments, including study of music from many periods. Student should check with the music program to determine what specific instrumental groupings will be formed that semester. Open by audition. Public performances required.

Faculty and Staff

**VICTOR VALLEY COLLEGE
FACULTY AND STAFF**
**FULL TIME FACULTY AND
ADMINISTRATORS**

Adell, Tim (1999)

Professor, English
B.A., North Park College
M.A., M.F.A., McNeese State University

Allen, Amber (2015)

Director, Special Grant Programs, RAMP UP Project
M.S., California Lutheran University
B.A., California Lutheran University

Alcorn, William (1969)

Professor Emeritus
B.A., Park College
M.S., University of Omaha

Allan, Peter (1997)

Professor Emeritus, Business Administration
B.A, M.B.A., California State University, San Bernardino

Ashton-Beazie, Janet (1978)

Professor Emeritus, Librarian
B.S.Ed., M.S., University of North Dakota

Ath, Yontha (2001)

B.A., California State University, Dominguez Hills
M.S., California State University, Long Beach
Ph.D., Claremont Graduate University

Augustine-Carreira, Jacqueline (2001)

Professor, Communication Studies
B.A., M.P.A., California State University, San Bernardino

Bachofner, William (1971)

Professor Emeritus, Psychology
B.A., University of San Diego
M.A., Chapman College

Basiri, Thomas (1997)

Professor Emeritus, Chemistry
Ph.D., Boston College

Beach, Kelley (2003)

Professor, Counseling
A.A., Victor Valley College
B.A., M.A., California State University, San Bernardino

Becker, Barbara (1993)

Professor, Business Education Technology
A.S., Victor Valley College
B.A., California State University, San Bernardino
M.B.A., University of Redlands

Bennett, Harry Lee (2000)

Professor, Automotive
A.S., Victor Valley College
B.A., Chapman University

Blanchard, Debra (1992)

Professor, Physical Education
A.A., Ventura College
B.A., California State University, Northridge
M.S., Arizona State University

Bonato, Anthony (2012)

Assistant Professor, Construction Technology
B.S., United States Naval Academy
M.B.A., San Diego State University

Bozonelos, Dino (2006)

Professor, Political Science
B.S., M.A., California State University, San Bernardino
Ph.D., University of California, Riverside

Bryan, T. Scott (1981)

Professor Emeritus, Geology/Astronomy
B.S., San Diego State University
M.S., University of Montana

Buckles, Duane (1985)

Professor Emeritus, Restaurant Management
A.A.S., Paul Smith's College of Arts and Sciences,
New York

Burg, Edward (1999)

Professor, Computer Information Systems
B.S., California State University, Fullerton
M.S., University of Phoenix

Butros, Michael (2000)

Professor, Physics
B.S., University of California, Irvine
M.S., Northern Arizona University

Campbell, Bryce (2003)

Professor, English
B.A., M.A., Ph.D., Washington State University

Carver, Nichole (2012)

Assistant Professor, Mathematics
B.S., University of Arkansas
M.S., Northern Arizona University

Cass, Reiji (1990)

Professor, Computer Information Systems
B.S., Shanghai Electronic Engineering College, China
M.S., South Dakota School of Mines and Technology

Cerreto, Richard (1998)

Professor, Anthropology
B.A., M.A., California State University, Fullerton

Chapman, James (1967)

Professor Emeritus, Mathematics
A.B., M.A., San Jose State College

Chou, Juanita (1983)

Professor Emeritus, Counseling
B.A., M.S., San Francisco State College

Clark, Tamala (2016)

Counselor, EOPS Counseling
B.A., California State University, San Bernardino
M.S., California State University, San Bernardino

- Cline, Diane (1979)
Professor Emeritus, Nursing
B.S., San Diego State College
M.S., California State University, Los Angeles
- Cohen, Heath (2015)
Instructor, Fire Technology
A.S., Crafton Hills College
- Cole, Marsha (2008)
Associate Professor, Child Development
B.A., M.A., California State University, San Bernardino
Ph.D., Capella University
- Contreras, Fernando (2000)
Professor, Counseling
B.A., University of California, Santa Cruz
M.A., San Jose State University
- Coultas, Steven (2016)
Instructor, Automotive
A.S., Victor Valley College
- Danielson, Milton (1961)
Professor Emeritus
B.A., University of California, Berkeley
B.D., Th.M., Berkeley Baptist Divinity School
Ph.D., University of Southern California
- Davis, Tracy (1999)
Professor, History
B.A., M.A., University of California, Riverside
- DeLong, Carol (1992)
Professor Emeritus, Geography
B.A., M.A., California State University, Long Beach
- Diaz, Felix (1971)
Counselor Emeritus
B.A., Los Angeles State College
M.A., Chapman College
- Dorn, Linda Lorena (2015)
Counselor, Counseling
B.A., University of California, Santa Barbara
M.S., California Lutheran University
Ed.D., Argosy University, Inland Empire
- Doyle, John (1990)
Professor, Allied Health/Paramedics
A.S., Victor Valley College
B.S., University of La Verne
B.S., Excelsior College, New York
- Duarte, Sean (2016)
Counselor, EOPS Counseling
B.A., Chapman University
M.A., Azusa Pacific University
- Dube-Price, Melanie (2009)
Counselor, Counseling
B.S., Cal Poly, Pomona
M.A., California State University, San Bernardino
- Dunsmore, Margaret (1988)
Professor Emeritus, Cooperative Education
B.S., University of Oklahoma
- Dupree, David (1988)
Professor, Political Science
B.S., Sterling College, Kansas
M.A., University of Kansas
- Eccleston, Joanne (1972)
Professor Emeritus, Child Development
A.B., University of Southern California
M.A., Pacific Oaks College
- Eklund, Laird (1989)
Professor Emeritus, English as a Second Language
B.S., Georgetown University, Washington, D.C.
M.A., University of Southern California
- Ekpo, Cathy (2017)
Director of DSPS
A.A., Crafton Hills College
B.A., California State University, San Bernardino.
M.S., San Diego State University
- Elgin, Frances (1980)
Librarian Emeritus
B.S., Southwest Missouri State University
M.L.S., San Jose State University
- Ellis, Lisa (1999)
Professor, History
B.A., M.A., Youngstown State University
- Ellerson, Patricia (2015)
Instructional Dean, Humanities, Arts and Social Sciences
A.A., Grossmont Community College
B.A., University of California, San Diego
Ph.D., University of California, Santa Barbara
- Embroden, Nord (1989)
Professor Emeritus, Construction Technology/Drafting
B.A., California State University, Long Beach
- English Jr., Herbert (2015)
Dean of Student Equity and Success
B.A., California State University, San Bernardino
M.A., University of Redlands
- Eydgahi, Hamid (2015)
Instructional Dean, Science, Technology, Engineering & Math
A.S., Owens Community College
B.S., University of Toledo
M.B.A., University of Saint Francis
Ph.D., Aston University (England)
- Faro, Thomas (1988)
Professor Emeritus, Electronics & Computer Technology
- Ferrance, Francis (1973)
Professor Emeritus, English
A.B., Stonehill College
M.A., University of Rhode Island
M.Ed., Bridgewater State College
Ph.D., University of Arizona
- Fields, Ronald (1992)
Professor Emeritus, Administration of Justice
B.A., M.A., California State University, Fullerton

- Flome, Robert (1979)
Professor, Psychology
B.A., San Fernando Valley State, Northridge
M.A., M.Ed., Chapman University
- Foster, John Franklin (1992)
Professor, Art/Photography
B.F.A., Memphis College of Art
M.F.A., California Institute of the Arts
- Fowlie, Jennifer (2016)
Instructor, Communication Studies
A.A., Victor Valley College
B.A., California State University, San Bernardino
M.A., California State University, San Bernardino
- Francev, Peter (2016)
Instructor, English
B.A., M.A., California State Polytechnic University
M.A., University College Dublin (Ireland)
- Franco, Cuauhtemoc (1990)
Professor, Spanish
B.A., M.A., California State University, Fresno
- Franklin, Nathan (2016)
Instructor, English
B.A., M.A., California State University, Fresno
- Galvez, Dixie (1976)
Professor Emeritus, Nursing
A.B., University of Redlands
M.P.H., M.S.N., Loma Linda University
- Garcia, Diego (1989)
Professor, Nursing
B.S., California State University, San Bernardino
M.S.N., Azusa Pacific University
- Garver, Kenneth (1970)
Professor Emeritus, Biological Sciences
B.S., Northern Arizona University
M.Ed., University of Arizona
- Gaytan, Manuel (1999)
Professor, EOPS Counseling
B.A., M.S., California State University, San Bernardino
- Gibbs, David (2004)
Professor, Biological Sciences
B.S., M.S., California State Polytechnic University, Pomona
- Gibbs, Jessica (2006)
Professor, Biological Sciences
B.S., University of California, Irvine
M.S., California Polytechnic University, Pomona
- Glebe, Andrea (1997)
Professor, English
B.A., B.A., Washington State University
M.A., Colorado State University
- Golder, Patricia (1997)
Professor, English/Basic Skills
B.A., M.A., California State University, San Bernardino
- Golliher, Carol (1987)
Professor Emeritus, Basic Skills
B.A., Alma College
M.A., Eastern Washington University
- Graham, David (2002)
Professor, Music
B.A., University of the State of New York
M.A., California State University, Dominguez Hills
- Grover, Christopher (1993)
Professor, Real Estate
B.A., California State University, San Bernardino
M.B.A., Heriot-Watt University, Edinburgh
- Guardado, Lynn (2001)
Professor, Dance
B.A., San Diego State University
M.A., California State University, San Bernardino
- Haines, Michael (2015)
Instructor, Respiratory Therapy
B.S., Touro University
M.A., California State University, San Bernardino
M.P.H., California State University, Fullerton
- Harvey, Lisa (1999)
Professor, Biological Sciences
B.A., Point Loma College
M.S., Ph.D., Loma Linda University
- Heaberlin, Jr. W. Edward (1996)
Professor, Theatre Arts/Communication Studies
B.F.A., M.A., Marshall University
- Hendrickson, Brian (2004)
Professor, Paramedic
B.S., M.S., Grand Canyon University
- Hollomon, David (1990)
Professor, Business Administration
B.S., California State University, Long Beach
M.A., California State University, Los Angeles
- Hoover, David (2000)
Professor, Physical Education/Football Coach
B.A., California State University, Los Angeles
M.Ed., Azusa Pacific University
- Huff, Norman (1967)
Professor Emeritus, Computer Information Systems
A.A., Victor Valley College
B.S., San Diego University
M.B.A., Golden Gate University
- Huiner, Leslie (2001)
Professor, Librarian
B.A., University of California, Riverside
M.L.S., San Jose State University
- Insley, Lyman (2016)
B.A., California State University, Fullerton
M.A., California State University, Long Beach
M.A., California State University, Dominguez Hills

- Irby, Kermit (1971)
Professor Emeritus, Business Administration
B.S., University of California, Davis
M.A., California State University, Los Angeles
- Irwin, Tom (1961)
Professor Emeritus, Biological Sciences
B.A., University of California, Santa Barbara
M.A., Chapman College
- Jalota, Naveen (2014)
Instructor, Biological Sciences
M.D., Iberoamericana University (Dominican Republic)
- James, Pamela (1997)
Professor, Counseling
B.S., California State University, Fullerton
M.A., California State University, San Bernardino
- Jennings, Patricia (2001)
Professor, Psychology
B.A., M.A., Antioch University
- Johnson, Eartha (2006)
Matriculation Counselor
B.A., University of California, Los Angeles
M.S., Columbia University, City of New York
- Jones, Gregory (2006)
Professor, Communication Studies
A.S., Mt. San Jacinto College
B.A., M.S., California State University, San Bernardino
Ph.D., Capella University
- Jones, Melanie (2017)
Dean of Instruction, Distance Education & Library Services
A.A., Huntington Junior College
B.S., Shawnee State University
M.A., Marshall University
Ed.D., Marshall University
Psy.D. (ABD) California Southern University
- Jones, Scott (2003)
Professor, Paramedic/EMS
B.S., Loma Linda University
M.B.A., University of Phoenix
- Kaiser, Hinrich (2002)
Professor, Biological Sciences
B.S., Ph.D., McGill University (Canada)
- Kelly, Margaret (1975)
Professor Emeritus, Nursing
B.S., M.S., California State University, Los Angeles
- Kennedy, Thomas (1998)
Associate Professor, Chemistry
B.S., University of Rochester
M.S., California State Polytechnic University, Pomona
- Kirkham, Robert (1979)
Professor Emeritus, Physics
B.A., University of California, San Diego
M.S., San Diego State University
- Kohlschreiber, Molly (1976)
Professor Emeritus, Art
B.A., M.A., Long Beach State College
- Kroencke, John (1971)
Professor Emeritus, Business Administration
A.B., M.A., San Jose State College
- Kuhns, Troy (2016)
Instructor, Welding
A.S., Victor Valley College
- Kumlin, Allan (1979)
Professor Emeritus, Cooperative Education
B.V.E., M.A., California State University, San Bernardino
- Lackey, Jennie A. (1967)
Professor Emeritus, Psychology
B.A., University of Minnesota
M.Ed., University of Montana, Missoula
- Longoria, Renate (2006)
Professor, Nursing
A.S., Victor Valley College
B.A., University of Redlands
M.S., California State University, Los Angeles
- Longshore, David (1973)
Professor Emeritus, Mathematics
B.A., Long Beach State College
M.S., University of Southern California
- Lopez, Arthur (2012)
Dean, Student Services
A.S., Southwestern College
B.S., University of Phoenix
M.S., Azusa Pacific University
- Luna, Starlie (1998)
Professor, Nursing
M.S., Loma Linda University
- Luther, Patricia (1990)
Dean Emeritus
B.S., University of Oregon
M.S., University of Michigan
M.A., San Diego State University
Ed.D., Nova Southeastern University
- Mackay, Pamela (1992)
Professor, Biological Sciences
B.S., B.S., M.S., California State Polytechnic University,
Pomona
- Malone, James Patrick (2000)
Professor Emeritus, Mathematics
B.A., M.S., Humboldt State University
- Marin, Tracy (2003)
Professor, Respiratory Therapy
A.S., Victor Valley College
B.S., M.P.H., Loma Linda University
Ph.D., University of California, Riverside

- Mauch, W. Patrick (2003)
Professor, Mathematics
B.S., College of Great Falls, Montana
M.S., Montana State University
- Mayer, Eric (1989)
Professor, History
B.A., M.A., Ph.D., University of California, San Diego
- McCracken, Michael (2000)
Professor, Counseling
B.A., University of California, Riverside
M.A., California State University, San Bernardino
- Mecklenburg, Trinity (2016)
Instructor, Mathematics
B.A., California State University, San Bernardino
M.A., California State University, San Bernardino
- Melkonian, Arda (1998)
Professor, Mathematics
B.A., California State University, San Bernardino
- Menser, Gary (1983)
Professor Emeritus, Industrial Arts/Welding
B.A., M.A., California State University, Long Beach
- Miller, David J. (1990)
Professor Emeritus, Counseling/Psychology
B.A., University of California, Berkeley
M.S., University of Wisconsin, Madison
Ed.D., U.S. International University, San Diego
- Miller, Thomas (1976)
Professor, Music
B.M., Biola University
M.M., M.S.M., Southern Methodist University
Ph.D., University of Southern California
- Milroy, Marjorie (1968)
Professor Emeritus, Communication Studies/Theatre Arts
B.A., San Jose State College, California
M.A., California State University, San Bernardino
- Mirci-Smith, Theresa (1990)
Professor Emeritus, Communication Studies
B.A., California State University, Sacramento
M.A., California State University, Fullerton
- Miskell, Karen (2016)
Instructor, Music
B.M., University of Miami
M.M., Northern Arizona University
- Montgomery, Jane (2015)
Instructor, Chemistry
B.S., University of Texas
Ph.D., Rice University
- Moon, Oscar Odell (1990)
Professor, Business Administration
B.S., California State Polytechnic University, Pomona
J.D., Western State University, Fullerton
- Moore, Adam (2016)
Instructor, Mathematics
M.A., California State University, San Bernardino
B.A., Chapman University
- Moran, Virginia (2006)
Executive Dean, Institutional Effectiveness
B.A., M.A., California State University, San Bernardino
- Maphumulo, Peter (2013)
Executive Vice President, Instruction and Student Services
B.A., Whitworth University
M.A., University of Montana
Ph.D., Washington State University
- Nelle, Stephen (2003)
Professor, Computer Integrated Design & Graphics
B.A., University of California, Santa Barbara
- Ngobi, Said (2006)
Professor, Mathematics
B.S., Makerere University
M.S., Ph.D., Louisiana State University
- Niehus, Monika (2016)
Instructor, English as a Second Language
B.A., Janus Pannonius University (Hungary)
M.A., School for International Training Graduate Institute
- Ochoa, Lorena (2007)
Associate Professor, Bilingual Counseling
B.A., M.S., California State University, Long Beach
- Ohshita, Christopher (2014)
Instructor, Aviation Technology
B.S., M.S., Embry-Riddle Aeronautical University
- Oleson, David (2006)
Professor, Paramedic
A.A., A. S., Chaffey College
B.S., Loma Linda University
M.S., Grand Canyon University
- Oliver, Claude (2001)
Professor, Computer Integrated Design and Graphics
B.S., California State University, Fresno
M.A., Chapman University
- Padgett, Rand (2016)
Instructor, Administrator of Justice
A.A., Fresno City College
B.S., M.S., California State University, Fresno
- Palmer, Rebecca (1989)
Professor Emeritus, Business Education Technology
B.V.E., California State University, San Bernardino
- Pendleton, Joseph (2001)
Professor, Reading Specialist
B.A., B.A., University of California, Irvine
M.A., Marquette University
M.A., University of California, Berkeley
- Pierce, Sherri (2000)
Professor, DSPS Counseling
B.A., M.A., California State University, San Bernardino

- Portillo, Silvia (2016)
Instructor, Nursing
A.S., Victor Valley College
B.S., M.S., California State University, Dominguez Hills
- Previte, James (1981)
Professor Emeritus, Psychology
B.S., University of California, Davis
M.A., Loyola Marymount University
- Price, Clova (1968)
Professor Emeritus, Business Administration
B.S., Oklahoma State University
M.A., Arizona State College
- Pugh, Donald (1974)
Counselor Emeritus
B.A., M.A., San Jose State College
Ph.D., University of Idaho
- Quan, Raymond (2016)
Director, Human Resources
B.A., Biola University
M.B.A., California State University, Dominguez
- Redona, Jeff (1999)
Professor, Mathematics
B.A., M.A., California State University, San Bernardino
- Richardson, Tracey (2016)
Vice President, Administrative Services
B.A., University of Southern California
M.B.A., California State University, Long Beach
M.S., San Francisco State University
- Ridge, Patrick J. (2001)
Professor, Mathematics
B.A., M.A., California State University, San Bernardino
- Ripley, Richard (1997)
Professor, Art
B.A., Kenyon College
M.F.A., Claremont Graduate School
- Risser, Joy (1975)
Professor Emeritus, Business Administration
A.B., Carthage College
M.A., University of Redlands
Ph.D., University of California, Los Angeles
- Rowland, Daniel (1993)
Professor, Automotive Technology
A.S., Victor Valley College
B.A., California State University, San Bernardino
- Rubayi, Khalid (2000)
Professor, Electronics & Computer Technology
B.S., M.S., Northrop University
- Rude, John (1997)
Professor Emeritus, Communication Studies/Theater Arts
B.S., Bemidji State College
M.A., Ball State University
Ph.D., University of Missouri
- Ruiz, Maria (1999)
Professor, English as a Second Language
B.A., San Jose State University
- Schellhous, Thomas (2016)
Instructor, Nursing (2016)
B.S., University of California, Riverside
M.A., California State University
Ph.D., University of California, Riverside
- Shahin, Louis (1984)
Professor Emeritus, Mathematics
B.S., M.S., University of California, Los Angeles
- Shaner, Keith (2012)
Instructor, Automotive
- Singh Record, Manika (2017)
Counselor, CalWORKS
B.A., M.A., California State University, San Bernardino
- Skuster, Marc (1977)
Professor Emeritus, Philosophy/Religious Studies
B.A., Simpson College
Rel.M., School of Theology at Claremont
Ph.D., Claremont Graduate School
- Slade, Neville (2001)
Professor, Horticulture
M.S., Colorado State University
- Smith, Carl (1994)
Director of EOPS and CARE
B.A., M.A., California State University, San Bernardino
- Smith, Michael (2001)
Professor, Education
B.A., University of California, Riverside
M.A., Pepperdine University
- Solis, Judy (1998)
Professor, English
B.A., M.A., Kent State University
- Speakman, Jeanine (2005)
Professor, Nursing
B.S., M.S., University of Phoenix
- Stahlke, Jacqueline (2015)
Counselor, DSPS Counseling
B.A., University of California, Irvine
M.S., Texas Tech University
- Stough, Mary Lynn (1992)
Professor, Mathematics
B.A., California State University, San Bernardino
M.S., University of California, Riverside
- Sweet, John (1996)
Professor Emeritus, Automotive
- Sypkens, Mary (1993)
Professor Emeritus, Child Development
B.S., University of La Verne
M.A., Pacific Oaks College

- Tashima, Eugene (1985)
Professor, Sociology
B.A., Humboldt State University
M.A., University of California, Los Angeles
- Taylor, Shuron (2001)
Professor, Computer Integrated Design and Graphics
B.A., M.P.S., New York University
- Thibeault, Sally (1999)
Professor, Nursing
B.S., M.S., California State University, San Bernardino
- Thomas, Shane (2000)
Professor, CIS
A.A., Victor Valley College
B.A., California State University, San Bernardino
- Tillman, Mary Susan (1987)
Counselor Emeritus, Learning Disabilities Program
Counseling
B.A., Biola University
M.A., Loyola Marymount University
- Tomlin, Karen (1987)
Professor, English
B.A., M.A., University of California, Santa Barbara
- Toner, Stephen (2002)
Professor, Mathematics
B.A., California State University, Fullerton
M.A., Chapman University
- Tonning, Paul (2000)
Professor, CIS (Web Development)
B.S., California State University, San Bernardino
- Trudeau, Lois (2016)
Instructor, Nursing
B.S., University of Florida
M.S., Georgetown University
- Truelove, Terry (2002)
Professor, Nursing
B.S., Oakland University, Michigan
M.S., University of Phoenix
- Vecchio, Daniel (2017)
Instructor, Philosophy
B.A., Assumption College
M.A., Boston College
Ph.D., Marquette University
- Victor, Bruce (1990)
Professor, Physical Education
B.S., California State University, Los Angeles
M.A., Azusa Pacific University
- Viehweg, Jarom (2016)
Instructor, Mathematics
B.S., M.A., California State University, San Bernardino
- Vila, Martha (1998)
Professor, Spanish
M.A., University of Nevada, Las Vegas
Ph.D., University of California, Santa Barbara
- Visser-Jones, Sandy (2003)
Professor, Child Development
B.S., M.S., University of La Verne
- Wagenhoffer, Joshua (2016)
Instructor, English
A.A., Fullerton College
B.A., M.A., California State University, Fullerton
- Wagner, Patricia (1999)
Professor, English
A.A., Long Beach City College
B.A., M.A., California State University, Long Beach
M.P.W., University of Southern California
- Wagner, Roger (2014)
Superintendent/President
A.A., Los Angeles Metropolitan College
M.A., University of Phoenix
Ph.D., University of Nebraska-Lincoln
- Walker, Kenneth (1974)
Professor Emeritus, Biological Sciences
B.A., Long Beach State College
M.S., Northern Arizona University
- Weis, Anh (2001)
Professor, Mathematics
B.A., M.A., California State University, San Bernardino
- White, Christa (1998)
Professor, Physical Education
B.S., Texas Tech University
M.Ed., Azusa Pacific University
- Wollan, Diane (2003)
Professor, Counseling
A.B., M.S., San Diego State University
- Young, Henry (1995)
Professor, Business Administration
B.S., California State Polytechnic University, Pomona
M.B.A., University of Phoenix

CLASSIFIED STAFF

- Albicker, Cristina (2012), Custodian
Allen, April (1986-2015), Distinguished Service
Allen, Kenyona (2006), Instructional Program Specialist
Allen - Charlotte (2014), Administrative Secretary II
Allen, Monique (2007), Sign Language Interpreter I
Alsina, Eileen (2008), Career Pathways Coordinator
Aragon, Esperanza (2006), Help Desk Technician
Armstrong, Terrie (1997), Instructional Assistant
Avila, Silvia (2004), Admissions and Records Technician
Bandringa, Pearl (2004), Senior Accounting Technician
Barnett, Patricia (1987-2008), Distinguished Service
Bazurto, Theresa (1999), Administrative Secretary II
Becker, Eric (2016), Senior Instructional Assistant
Becker, Valerie (2006), Senior Instructional Assistant
Bell, Galene (2008), Lab Aide
Bennett, Lisa (2012), Sign Language Services Interpreter I
Bennett, Terrie ((2012), Sign Language Services Interpreter II
Blanca, Gomez (2006), Sign Language Services Interpreter II
Board, Frederick (2006), Warehouse Delivery Worker
Brown, Amber (2016), Administrative Secretary II

Bryant, Vaughn (2010), Custodian
 Buck, Patricia (2006), EOPS Specialist
 Burch, Ashley (2014), Program Specialist-Special Grants
 Burham, Sheila (2008), Help Desk Technician
 Bustillos, Hector (2013), Maintenance Worker
 Bustillos, Raina (2007), Payroll Manager
 Caldwell, Sheree (1999), WIA/CalWORKS Coordinator
 Campos, Marena (2006), Switchboard Operator/Receptionist
 Cardoza, Maria (2004), Admissions & Records Technician
 Cardoza, Ted (2008), Custodian
 Carpenter, Malia (2005), Curriculum Scheduling Coordinator
 Carter, Lauren (2009), Sign Language Services Interpreter II
 Casler, Arthur (1997), Maintenance Worker
 Castano, Andres (2014), Sign Language Services Interpreter II
 Castleman, Darlene, (1978-1998), Distinguished Service
 Chavez, Fernando (2011), M&O Clerical Technician
 Chavez, Magdalen (2007), Human Resources Technician
 Chavez, Rocio (2004), Senior Human Resources Analyst
 Cheung, Stephen (2015), Network Manager
 Christiansen, Julie (2000), Clerical Technician II
 Christian, Nancy (1988), Performing Arts Center Technician
 Clair, Mark (1999), Institutional Research Coordinator
 Compton, Noanna (2000), Senior Human Resources Analyst
 Cook, Jonathan (2003), Senior Instructional Assistant
 Cooper, David (2006), Custodian
 Cortez, Heather (2016), Admissions and Records Technician
 Cripps, Lisa (2006), Admission & Records Specialist
 Cross, Douglas (1998), Senior Instructional Assistant
 DaCosta, Debra (1988), Accounting Specialist
 Dascenzo, Stacey (2009), Sign Language Services Interpreter II
 Dance, Tamara (1990), Admissions & Records Specialist
 Daughton, Sueann (2016), Library Technician
 Davies, Kristin (2015), Payroll & Benefits Technician
 Derryberry, Donna (1998), Research Analyst
 DeWald, Scott (2015), Network Manager
 Dove, Randy (2007), Grounds Maintenance Worker
 Duarte, Elizabeth (2006), Upward Bound Coordinator
 Durham, Carl (2006), Bookstore Operations Assistant
 Dwiggin, Steve (2007), Grounds Maintenance Worker
 Espinoza, Amy (2014), Accounting Technician II
 Espinoza, Jan (2001), Office Assistant
 Embrey, Vira (1990-2008) Distinguished Service
 Falkowski, Jeri Kay (2010), Senior Human Resources Analyst
 Finch, Tammy (2002), Grounds Maintenance Worker
 Finch Jr., William (1984), Lead Maintenance Worker
 Flenna, Michael (1997), Custodian
 Flenna, Peter (1997), Custodian
 Ford, Carole, (1999), Senior Instructional Assistant
 Foster, Sheri Nolan (1985-2011), Distinguished Service
 Fraydealvaro, Deydalia (2015), Classified Site Supervisor CDC
 Garcia, Carly (2007), Sign Language Services Interpreter II
 Garcia, Josanna (2006), Director, Budget and Planning
 Garcia, Joseph (2016), Maintenance & Operations Mngr. (Night Shift)
 Garcia, Stephen (1989), Executive Director, Facilities & Operations
 Garrett, Steven (2006), Custodian
 Gatewood, Justin (2006), Webmaster
 Gonzales, Salena (2004), Campus Police Officer
 Gonzalez, Federico (2014), Police Field Supervisor
 Harriman, Darrell, (1999), Electronics Lab Specialist
 Henning, Lorie (2001), Senior Accounting Technician
 Henry, Hank (2007), Sign Language Services Interpreter I
 Henry, Jennifer (2016), Administrative Secretary II
 Herd, Brandy (2007), Sign Language Services Interpreter II
 Hernandez, Abraham (2012), Custodian
 Hernandez, Fabiola (2011), Administrative Secretary II
 Hernandez, Joseph (2011), Custodian
 Hernandez, Ralph (2006), Grounds Maintenance Worker
 Hernandez, Yvonne (2002), Senior Instructional Assistant
 Hill, Carol (2006), Payroll & Benefits Technician
 Hinojos, Susan (2002), Instructional Assistant
 Hoskins, John (2010), Laboratory Aide
 Howie, Brian (1997), Maintenance Worker
 Huggins, LaDonna (2001), Office Assistant
 Hussing, Cathy (2007), Accounting Technician I
 Icasiano, Jody (2015), Campus Police Reserve Officer
 Isbell, Timothy (2007), Media Services Coordinator
 Jacquez, Noreen (1999), Campus Police Officer
 Jafari, Fatemeh (2015), Inst. Network Comp. Maint. Technician
 Janisko, Gina (1998), Financial Aid Specialist
 Jasso, Evelyn (1998), Office Assistant
 Jimenez, Susana (2010), Instructional Assistance
 Jimenez, Thomas (2013), Lead Warehouse/Delivery Worker
 Johnson, Kelley (2007), Director, Child Development Center
 Jones, Dennis (2011), Campus Police Officer
 Jordan, Pacita (2000), Office Assistant
 Judkins, Jason (2014), Director, Financial Aid
 Kagy, Margaret (1994-2015), Distinguished Service
 Katona, Donald (2012), Senior Systems Analyst
 Kennedy, Jason (2015), Placement Specialist, Career CTR
 Kingman, Kelley (2006), Accounting Technician I
 Knight, Leonard (2010), Chief, Campus Police
 Kuhns, Marianne (2014), Administrative Secretary I
 Kuyper, Mark (2017), Office Assistant
 Kwan, Michael (1997), Senior Instructional Assistant
 Landin, Hilda (2007), Administrative Secretary II
 Lares, Sonia (2003), Office Assistant
 Larriva, Jennifer (2007), Research Analyst
 Laveaux, B. Michele (1997), Instructional Designer
 Lee, Seok (2015), Campus Police Officer
 Lewis, Nancy (2006), Accounting Technician II
 Lobato, Barbara Ann (2012), Sign Language Services Interpreter I
 Lough, Margie (1972-1998), Distinguished Service
 Macias, Elena (2009), Sign Language Services Interpreter I
 Maciel, Denise (2005), Sign Language Services Interpreter II
 Maldonado, Justin (2007), Campus Police Reserve Officer
 Manriquez, Veronica (1997), Placement Specialist
 Markegard, Therese (2006), Campus Police Specialist
 Marlatt-Martinez, Kortney (2016), Clerical Technician II
 Martin, Mary (1987-2008), Distinguished Service
 Martinelli, Victoria (2008), Executive Assistant (President's Office)
 Martinez, Carlos (1997), Help Desk Technician
 Mata, Kathy (1998), Accounting Technician II
 Mauter, Mary (2009), Sign Language Services Interpreter II
 Mazzola, Mary (2015), Auxiliary Services Assistant
 McComas, Annette (2000-2015), Distinguished Service
 McCoy, Joseph (2005), Sign Language Services Interpreter II
 McCoy, Tonya (2006), Accounting Technician II
 McDaniel, Linda (2002), Switchboard Operator/Receptionist
 McDonald, Gabriel (2006), Sign Language Serv. Interpreter II
 Melendez, Simon (1982-2000), Distinguished Service
 Mendez, Martha (2004), Project Manager, Special Grants/Contracts
 Messer, Monty (1996), Lead Warehouse/Delivery Worker
 Meyer, Archie (2012), Laboratory Technician
 Moon, Greta (1990), Director, Admissions and Records
 Moore-Talley, Joseph (2008), Custodian
 Morales, Gisel (2007), Financial Aid Specialist
 Morales, Xochitl (2006), Senior Instructional Assistant
 Moreno, Sandra (2001), DSPS Specialist
 Morgan, Joi (2016), Administrative Secretary I
 Mulligan, B. Scott (1998), Printing Services Specialist
 Murphy-Sanabria, Deanna (2000), Director, Auxiliary Services
 Murray, James (2002), Financial Aid Specialist
 Navarrete, Elaine (2005), Financial Aid Specialist

Navarro, Ray (1998), Senior Instructional Assistant
 Norris, Amy (2013), Human Resources Specialist
 O'Brien, Janice (2006), Sign Language Services Interpreter II
 O'Brien, Mary Jo (1983-2000) Distinguished Service
 Ortiz, Paulette (2002), Administrative Secretary I
 Owens, Shannon (2016), Library Technician
 Painter, Michelle (1999), Administrative Secretary II
 Pearson, Eric (1981-2015), Distinguished Service
 Palacios, India (2015), Student Service Specialist
 Penfold, Suzanne (2012), Program Specialist, Special Grants Prgrms.
 Perdomo, Angela (2008), Financial Aid Technician
 Peters, Brian (2015), Inst. Network Comp. Maint. Technician
 Peterson, Deborah (2000), Senior Instructional Assistant
 Peters, Brian (2015), Inst. Network Comp. Maint. Technician
 Poron-Barrios, Cristhal (2015), Inst. Network Comp. Maint. Technician
 Pouvaranukoah, Cynthia (2016), Instructional Program Specialist
 Prewett, Deborah (2004), Auxiliary Services Specialist
 Prieto, Angela (1977), Library Technician
 Pringle, Mary (1984-2011), Distinguished Service
 Pugliese, Reba (2006), Curriculum Scheduling Coordinator
 Rempfer, Maria (2001), Bookstore Operations Assistant
 Reyes, Eddie (2000), Grounds Maintenance Worker
 Reyes, Jessica (2007), Accounting Technician I
 Reyes, Joanna (1999), Custodian
 Reyes, Renee (2003), Accounting Technician II
 Richards, Patricia (2009), Sign Language Services Interpreter II
 Richards, Robbie (2002), Financial Aid Specialist
 Richardson, Chad (2007), Custodian
 Richardson, Randy (2007), Campus Police Reserve Officer
 Rickards, Alex (2006), Lead Grounds Maintenance Worker
 Riley, Norma (2016), Admissions and Records Technician
 Rivera, Silvestre (2007) Campus Police Reserve Officer
 Robillard, Teresa (1998), Clerical Technician II
 Robles, Victoria (2016) Campus Police Officer
 Rodriguez, Jorge (2013), Campus Police Reserve Officer
 Rodriguez, Melina (2002), Administrative Secretary I
 Romberger, Robert (2006). Inst. Network Comp. Maint. Technician
 Ruby, Peggy (1998), CDC Permit Teacher
 Sandello, Margie (1993), Coordinator, Student Services
 Sandoval, Mark (2006), Maintenance Technician
 Santillan, Jazmin (2011), Administrative Secretary II
 Schneider, David (2006), Maintenance Locksmith
 Selby, Suzan (2005), Instructional Program Specialist
 Sewell, Robert (1994), Director, Marketing & Public Information
 Sharp, Ann Marie (2002), Administrative Secretary II
 Shubin Jr., Willie (2011), Custodian
 Sisk Diana (2003), Sr. Instructional Assistant/Instructional Assistant
 Snell-Gonzales, Shirley (2000), Administrative Assistant
 Stalians, Jeff (2003), Senior Instructional Assistant
 Steinback, David (1995), Senior Instructional Assistant
 Stockman, William (2006), Instructional Assistant
 Stump, Carole (2003), Library Technician
 Tashima, Julia (1992), Director of Athletics/Athletic Trainer
 Tejas, Stephen (2006), Instructional Assistant
 Teeter, Hailey (2016), Payroll & Benefits Technician
 Thoms, Renny (2013), Lead Systems Programmer/Analyst
 Topete, Violeta (2017), Administrative Secretary II
 Tran-Quang, Cam-Quynh (2005), Sr. Programmer/Software Devlpr.
 Turner, Nancy (2004), Deaf & Hard of Hearing Specialist
 Ullger, Kendra (2004), Bookstore Operations Assistant
 Vaughn, Audrey (2006), Administrative Secretary II
 Vera, Jessica (2016), Administrative Secretary I
 Vidana-Barda, Marie (1990), Senior Accounting Technician
 Vigil, Donna (2007), Admissions & Records Specialist
 Vineyard, Ryan (2015), Inst. Network Comp. Maint. Technician
 Von Ins, Joy (2006), Library Technician
 Wack, Gerald (2002), Custodian
 Walker, Frank (1998), Printing Services Technician
 Walton, Florine (2006), Administrative Secretary II
 Wilkin, Amy (1998), Athletic Trainer
 Williams, Clyde (2017), Athletic Equipment Technician
 Williams, Elliot (2012), Sign Language Services Interpreter I
 Winburn, David (2007), Campus Police Reserve Officer
 Witt, Patricia (2006), Clerical Technician II
 Wyman, Nathaniel (2007), Sign Language Services Interpreter II
 Youngs, Albert (2000), Senior Instructional Assistant
 Zamora, Francisco (2006), Grounds Maintenance Worker
 Zhu, Yong (2005), Database Administrator
 Zipp, Tanya (2007), Laboratory Technician

Index

3D Animation	103	Authorization Codes	36
A		Automotive Brake and Suspension Specialist Certificate	157
A+ Certification Examination Preparation Certificate	255	Automotive Detailer/Porter Certificate	157
AB540 Nonresident Tuition Waiver	71	Automotive Driveability Specialist Certificate	157
About Your Campus	14	Automotive Inspection and Maintenance Technician Certificate	157
Academic Calendar	Inside Front Cover	Automotive Repair Shop Manager Certificate	157
Academic Commons	14, 242	Automotive Specialist I Certificate	157
Academic Counseling	42	Automotive Specialist II Certificate	158
Academic Freedom	21	Automotive Technician Certificate	158
Academic and Progress	67,68	Automotive Technology	156
Academic Renewal Policy	53	Automotive Transmission Specialist Certificate	158
Academic Standards	64	Aviation	165
Accident Insurance	25	Aviation Airframe Technician Certificate	165
Accreditation	3,96	Aviation Maintenance Technology, AS	165
Acoso Sexual	27	Aviation Powerplant Technician Certificate	166
Adaptive Computer Technology Lab (ACT,) The	42		
Adapted Physical Education	104	B	
Adaptive Physical Fitness (ADPE) Non-Credit Course	422	Basic Business Real Estate Certificate	176
Administration	7	Basic Electrician Technician Certificate	228
Administration of Justice (Criminal Justice)	97	Basic Heating, Ventilation, Air Conditioning and Refrigeration (HVAC/R) Service Technician Certificate	228
Administration of Justice, AS-T	109	Basic Machining Certificate	230
Administration of Justice (Criminal Justice) Courses	112	Basic Residential Maintenance Certificate	229
Administration of Justice Certificate	110	Basic Skills	168
Administrative Assistant Certificate	182	Basic Skills/Educational Upgrade- Non-Credit Courses	423
Admissions and Registration	30	Basic Woodworking Certificate	230
Admission, Eligibility for	31	Biological Science	169
Adult/Community Education	13	Board of Trustees	6
Advance Paralegal Studies Certificate	371	Bookkeeping I Certificate	177
Advanced Placement Credit (AP)	61,62	Bookstore	16,71
Advanced Placement Exam (CEEB)	60	Breadth Requirements, CSU	63,90
Agriculture and Natural Resources	116	Building Construction Certificate	227
Agriculture and Natural Resources Career Exploration Certificate	118	Building Inspection Certificate	227
Agriculture and Natural Resources Courses	130	Bureau of Indian Affairs	69
Air Force ROTC	45	Business	174
Alcohol & Drugs Policy	29	Business Administration	175
Alcohol & Drug Studies	136	Business Education Technologies	181
Allied Health	137	Business Real Estate and Escrow	189
Alternative Parking Options	71	Business Real Estate Apprentice Certificate	190
Amenities	18		
American Sign Language	141	C	
Americans With Disabilities Act (ADA)/504	26	CADD Technician I Certificate	219
Anatomy (see Biological Science)	169	CalWORKS	41
Animal Health Technician Certificate	119	Calendar for the Year	Inside Front Cover
Animal Science Specialist Certificate	120	Cal-Grant	68
Animation (See Computer Integrated Design & Graphics and Mert)	218,339	California State University	60,63,89
Anthropology	142	CSU and UC Transfer Information	86
Application for Graduation	78	Campus Complexes	14
Application Deadlines to CSU and UC Systems	94	Campus Culture & Climate	9
Architectural CADD Technician I Certificate	219	Campus Locations and Services	14
Architecture	144	Campus Law Enforcement Course: PC 832 Certificate	110
Art and Design	145	Campus Security/Police	18,27
Articulation, Benefits	57	Campus Police	27
Assessment	41	Campus Police Services	18
Assessment Exemptions	47	Career Center	41
Associate Degree Majors	80	Career Planning	42
Associate Degree for Transfer	75,80,81	Career/Transfer Center	41
Associate Degree Graduation Requirements	79	Career Technical Education (CTE)	57
Associated Student Body (ASB) Privileges	44	Catalog Rights	77
Astronomy	150	Challenge to Matriculation	48
Athletics	20,151	Cheating/Plagiarism	24
Attendance	53	Chemistry	194
Auditing	56	Child Development	196
Authority of Instructors	53	Child Development Center	19
Authority to Determine Residence	32	Child Development Lab Classroom	19
		Citations	28

CISCO Networking Academy I, II Certificates	252	Drug and Alcohol-Free Campus	29
CISCO Networking Academy III, IV, V, VI, VII Certificates	253	DSPS Courses	42
Classroom Complexes	21		
Classroom Discipline	24	E	
CLEP (College Level Examination Program)	63	Early Childhood Development	197
Clubs	20,44	Economics	245
College History	10	Education	246
Commercial Art	204	Education Technology Certificate	247
Communication Center	18	Education Technology Courses	248
Communication Studies	205	Electronics Engineering Technology, AS (Electronic and Computer Emphasis)	251
Communication Studies, AA-T	206	Electronics Engineering Technology Certificates (Electronic and Computer Emphasis)	251
Community & Contract Education	13	Electronics Technology Certificate	254
Community Service	13	Eligibility and Qualifications for Financial Aid	67
Computers	206	Emergency Phones	18
Computer Aided Drafting Certificate	207	Emergency Medical Services	263
Computer Animation	103,218	Emergency Medical Services, AS	263
Computer Graphics (See CIDG, Media Arts and Commercial Art)	204,208,218,339	Emergency Medical Technician Refresher Certificate	264
Computer Information Systems	209	Engineering	267
Computer Integrated Design and Graphics	218	English	268
Computer Systems I Certificate	182	English, AA-T	269
Computer Systems II Certificate	183	English as a Second Language (ESL)	12,275
Computer Technology Certificate	252	English as a Second Language Non-Credit (AENG) Courses	424
Concurrent Enrollment	33,35,36	English and Reading Course Sequence	52
Construction and Manufacturing Technology	225	Enrollment Fee	70
Construction and Manufacturing Technology Courses	231	Environmental Horticulture and Restoration Technician Certificate	121
Construction Management Certificate	228	Environmental Studies	282
Construction Technology, AS	226	Equal Opportunity Policy	25
Construction Technology Certificate	226	Equine Science Specialist Certificate	122
Construction Technology Maintenance Courses	239	Extended Opportunity Program and Services (EOPS)	43
Construction Technology Manufacturing Courses	237	External Exam Credit	58
Construction Technology Public Works Courses	240	Expanded Animation Technician 3ds Max Certificate	220,342
Cooperative Work Experience Education	242	Expanded Animation Technician Maya Certificate	340
Corrections Officer Core Course Certificate	110	F	
Counseling Services	42,48	Faculty and Staff	428
Course Descriptions	59,75,93	Federal Pell Grant	69
Course Identification (C-ID)	82	Federal Supplemental Educational Opportunity Grant (FSEOG)	69
Course Numbering System	74	Federal Work Study Program	69
Course Equivalency	58	Fiber Optic Cabling Technician Certificate	255
Course Repetition	54	Financial Aid	67
Credit by Examination	56	Financing Your Education	66
Credits from Other Institutions	59	Fine Arts	283
Credits and Units (See Units and Credits)	48	Fingerprint Recognition and Classification Certificate	110
Criminal Justice (see Administration of Justice)		Fire Fighter Academy	285
D		Fire Fighter Certificate	286
Dance (see Kinesiology Dance)	322	Fire Prevention Officer Certificate	286
DANTES (Military Service Schools Defense Activity for Non-Traditional Education Support)..	56	Fire Technology	284
Data Typist Certificate	183	Floral Design Technician Certificate	122
Deciding how many units to take	48	Foreign Coursework	59
Definitions of Student Classifications	35	Forensic Specialist Certificate	110
Degrees and Certificates	12,74,100	French	297
Developmental Studies	244	Full Time Student Success Grant (FTSS)	68
Digital Animation (see Computer Integrated Design & Graphics and Media Arts "Mert")	218, 339		
Digital Animation Artist 3ds Max Certificate	221,341	G	
Digital Animation Artist Maya Certificate	340	General Cooperative Work Experience Education	242
Digital Animation Technician I 3ds Max Certificate	221,341	General Education Requirements	59,75,78,90,91,98
Digital Animation Technician I Maya Certificate	340	California State University	90
Digital Design (See CIDG, Media Arts, Commercial Art)	204,218,339	University of California	86
Digital Electronics Certificate	254	General Information About Transferring	93
Digital Filmmaker Certificate	220,341	Geography	299
Disabled Student Programs and Services (DSPS)	42	Geography, AA-T	300
Disabled Student Programs and Services (DSPS), How to Apply	43	Geological Sciences	302
Discrimination Complaint Procedure	26	Geospatial Technician Certificate	123
Dismissal	64	Grade Appeal Process	50
Distance Education	13	Grade Point Average (GPA)	50
Drafting Technician I Certificate	219	Graduation Honors	36

Graduation Requirements - VVC	79	Math Success Center	17,43
Graphic Arts (see Computer Integrated Design and Graphics and Mert)	218, 339	Matriculation	47
Guaranteed Transfer to CSUSB	90	Matriculation Steps	47
Guidance	303	Maximum Transferable Credit	95
H		Maximum Units in Remedial Classes	49
Harassment, Sexual (see Sexual Harassment)	26	Media Arts (MERT)	339
Head Start	19	Medical Assistant	354
Health	305	Medical Assistant Certificate	355
Heating, Ventilation, Air Conditioning and Refrigeration (see Construction Technology)	225	Medical and Health Professions	344
History	306	Athletic Training	344
History ,AA-T	307	Dental Hygiene	344
Home Economics For The Homemaker (AHOM) Non-Credit Courses	426	Health Care Management	345
Home Health Aide (See Allied Health)	137	Pre-Medicine	346
Honors	310	Occupational Therapy	347
Horticulture Specialist Certificate	125	Occupational Therapy Assistant	347
I		Pre-Dentistry	345
IGETC (Intersegmental General Education Transfer Curriculum)	87	Pre-Osteopathic Medicine	348
Impacted Majors...	94	Pre-Pharmacy	348
Incomplete Grades	55	Pre-Physical Therapy	349
Independent Study	313	Pre-Physical Therapy Assistant	350
Information for ESL Students	12	Pre-Physician Assistant	350
Information para Estudiantes de Ingles Como Segundo Idioma	12	Pre-Podiatry	351
Instructional Programs/Course Descriptions	99	Radiologic Technology	351
International Students	33	Speech-Language Pathology and Audiology	352
International Studies Certificate	384	Sports Medicine	352
Irrigation Designing Technician Certificate	126	Pre-Veterinary Medicine	352
J		Medical Office Certificate	184
Journalism	314	Microbiology (see Biological Science)	169
K		Microsoft Certified Systems Engineer Level I, II Certificate	255
K16 Bridge Program	43	Military Service	60
K16 Bridge Scholar Program	43	Mission Statement	8
Kinesiology	316	Motorcycle Repair Technician Certificate	145
Kinesiology, AA-T	317	Music	356
Kinesiology Dance	322	Music (AMUS) Non-Credit Courses	427
L		MySQL Database Developer Certificate	210
Landscape Specialist Certificate	124	N	
Law	328	N+ Certification Examination Preparation Certificate	256
Law Enforcement (see Administration of Justice)	107	Natural Resource Management Technician Certificate	127
Law Enforcement Module III Basic Course Certificate	110	Network Cabling Technician Certificate	255
Law Enforcement Module II Basic Course Certificate	111	Network Specialist Certificate	210
Learning Outcomes	97,98	Non-Credit Courses	422
Legal Office Certificate	185	Non-Degree Applicable	58,74
Liberal Arts	335	Non-Discrimination Policy	26
Level I: Associate Teacher (Preschool) Certificate	198	Non-Resident Tuition and Fees	70
Level II: Teacher (Preschool) Certificate	199	Nontraditional Degrees	84
Level III: Site Supervisor (Preschool) Certificate	199	Notice of Responsibility	95
Liberal Arts Major	329	Nursing	363
Library	17	Nursing, AS	366
M		Nursing Assistant/Home Aide Certificate (see Allied Health)	137
Management Certificate	177	Nursing Licensure Certificate	366
Managing Your Education	46	O	
Managing Work and College Recommendations	49	Occupational Certificates	74
Maps		Oceanography	369
California State University	85	Off Campus Locations	15
University of California	81	Official Transcripts	59,74,79,94
VVC Map	Inside Back Cover	Office Services Certificate	184
Math/Science	331	Open Class Policy	21
Mathematics	332	Other Campus Regulations	23
Mathmatics, AS-T	333	P	
		Paralegal Studies.	370
		Paralegal Studies Certificate	371
		Paramedic (See Emergency Medical Services)	263
		Paramedic Certificate	264
		Parking Enforcement & Regulations	28
		Parking Fees/ASB Fees	71
		Pass/No Pass Option	55

Payment of Fees Deadlines	36	Security/Police Campus	18
PC 832 Firearms Only Certificate	111	Services for Students	40
PC 832 Laws of Arrest Course Certificate	111	Sexual Harassment	26
Pell Grant	69	Sign Language	141
Performing Arts Center	20	Smog Inspection Technician Certificate	158
Petitions Committee	57	Smoke-Free Campus	29
Petitions Process	32	Social/Personal Development Counseling	42
Phi Theta Kappa...	18,20,34,43,44	Sociology	404
Philosophy	374	Sociology, AA-T	405
Photography	376	Spanish	407
Photography Certificate	376	Special Part-time/Full-time Students...	33
Physical Sciences	379	Special Topics Courses	409
Physics	380	Speech Communications (see Communication Studies)	205
Physiology (see Biological Science)	169	Spreadsheet Processor Certificate	183
Placement, Assessment	60	Staff	428
Plagiarism	24	Student Accident Insurance	25
Plant Science Technician Certificate	128	Student Activities	44
Plumbing Technician Certificate	229	Student Activities Center	18
Police Technician Specialist Certificate	111	Student Affirmative Action Plan	27
Polítca No Discriminatoria	26	Student Body Privileges	44
Political Science	382	Student Center Fee	71
Political Science, AA-T	383	Student Clubs	44
Prerequisites/Corequisites/Advisories	37	Student Conduct	21
Principle of Progressive Discipline	24	Student Conduct Code - Rule and Regulations	22
Proceso para Establecer Residencia en California	32	Student Government	45
Probation and Dismissal Policies	64	Student Grievances	25
Probation, Academic	64	Student Handbook	21
Probation, Progress	64	Student Honors	38
Productivity Software Specialist Certificate	211	Student I.D. Card	25
Programming I Certificate	210	Student Responsibilities	21
Programming II Certificate	211	Student Registration Priorities	34
Program Changes (Adding/Dropping)	36	Student Representation Fee	71
Programs of Study	94	Student Record Notice/Directory Information	27
Psychology	387	Student Services Lab	44
Psychology, AA-T	388	Superintendent/President's Message	5
Public Works Certificate	229		
Q			
Quarter to Semester Conversion	59		
R			
Rams Bookstore	16		
Real Estate (see Business Real Estate)	189		
Refund Policies	72		
Regional Occupation Program (see CTE)	16		
Regional Public Safety Training Center	16		
Registration	34		
Registration Priorities, Student	34		
Registration Requirements	35		
Reglamento Imparcial de Oportunidad	26		
Religious Studies	392		
Renewable Energy Certificate	230		
Repetition of Courses	48		
Requirements (CSU) General Education	35		
Requirements for Degrees/Certificates	75		
Requirements for Graduation	75		
Requirements for Registration	35		
Residency Requirements	31		
Respiratory Therapy	394		
Respiratory Therapy, A.S.	395		
Responsibilities of the College (Matriculation)	47		
Responsibilities of the Student	47		
Restrooms	18		
Restaurant Management	398		
Restaurant Management Certificate	399		
S			
Satisfactory Standing	53		
Scholarships and Grants	70		
T			
Transfer		58,93	
UC		86	
CSU		90	
Transfer General Education Pass Along Certification		59	
Teaching (see Education)		246	
Tech Prep (see Career Technical Education)		57	
Technical Education		12	
Textbooks and Small Supplies		71	
Theatre Arts		410	
Ticket Information Center		20	
Transcripts for Admissions		37	
Transcripts of Records		94	
Transfer to a four-year College		84	
Transfer Center		93	
Transferable Credits		87,88,91,95	
Transferring, General Information		58, 74	
Transferring to CSU		90,91	
Transferring to UC		86,87	
Tuition and Fees		70	
Tutoring		17	
U			
University of California (UC)		85	
Units and Credits		48	
UNIX Administrator Certificate		212	
V			
VAWA		28	
Vending Machines		18	
Veterans and Service Credit		60	
Veterans Benefits		69	
Violation of Law and Victor Valley College Discipline		24	
Vision, Values, Mission and Goals		8	

VVC Math Pathways 51

W

Wait List 37

Water Resource Management Certificate 129

Web Authoring Certificate 212

Welding 418

Welding Certificate 419

Wireless Communication Technology Certificate 256

What We Offer 12

 Degrees and Certificates 12

 Technical Education 12

 Information for ESL 12

 Información Para Estudiantes de Inglés Como Segundo

 Idioma 12

Withdrawing from Class 37,53

Withholding of Student Records 38

Word Processor Certificate 183

Work Experience 242

Writing Center 44

“W” Grade Symbol 53

Notes Page

Academic Commons - 42
 Adapted P.E. Center - 70
 Administration of Justice - 66A
 Admin. Services - 10
 Board Room
 Center Institutional Excellence
 Facilities Construction
 Human Resources
 Institutional Research
 VP Admin. Services
 Admin. Annex - 10A
 Contract Education Lab
 Fiscal Services
 Payroll

Agriculture & Natural Resources - 60
 Agriculture/Labs - 60A,B,C
 Allied Health - 32
 Allied Health Portables - 32A,B,C
 Art - 22
 Automotive - 64
 Auto/Welding - 67
 Campus Police - 80
 Child Development Center - 12
 C.I.D.G. - 63
 Construction Technology - 65
 Counseling & Administration - 55
 Assessment
 Career/Transfer Center
 Counseling
 Foundation
 Superintendent/President
 Exec. VP Instruction & Student Services
 Digital Animation - 80
 Electrical/PowerPlant - 40

Electronics - 62
 Elevator - 43
 Excelsior Education Center - 11
 Gymnasium - 71
 Health & Science Building - 33
 (Dr. Prem Reddy)
 Humanities Center - 80
 Campus Police
 Digital Animation
 Park Univ.
 RampUP
 Liberal Arts - 30

Library - Learning Resource Center - 41
 Maintenance Office - 93
 Music - 20
 Performing Arts Center - 54
 Planetarium - 31
 Printshop - 90
 RampUP - 80
 Science - 31

Student Activities Center - 44
 A.S.B. Offices & A.S.B. Computer Lab
 Auxiliary Services
 Bookstore
 Desert Rock Cafe
 Food Court
 P.T.K. Honor Society
 Public Information Office
 Veterans Resource Center
 Student Services 1 - 52
 Admissions/Records
 Bursar
 Financial Aid
 Instructional Media Services
 Veterans Affairs
 Student Services 2 - 50
 CalWorks
 CARE
 DSPS
 EOPS
 Sign Language Interpreters
 Student Employment

Upper Portables 51A,B,C
 Veterans Resource Center - 44
 Warehouse - 91
 Welding - 61

IMPORTANT VVC NUMBERS:
(760) 245-4271
Campus Police Office x2329
 after hours & weekends **x2555**
Emergency 911

- BUS STOP
- METERED PARKING
- PARKING PERMIT DISPENSER
- EMERGENCY PHONE
- EMERGENCY COORDINATION



SPRING VALLEY PKWY.
 To access the west side of Upper Campus use this entrance.

JACARANDA AVE. - To access the east side of Upper Campus use this entrance. Exit at Spring Valley Pkwy. or Fish Hatchery Rd.

FISH HATCHERY RD.
 To access all of Lower Campus use this entrance.

EASY ACCESS

REV. 3/16